

ASUS[®]

BE24ECSBT Series

LCD Monitor

User Guide

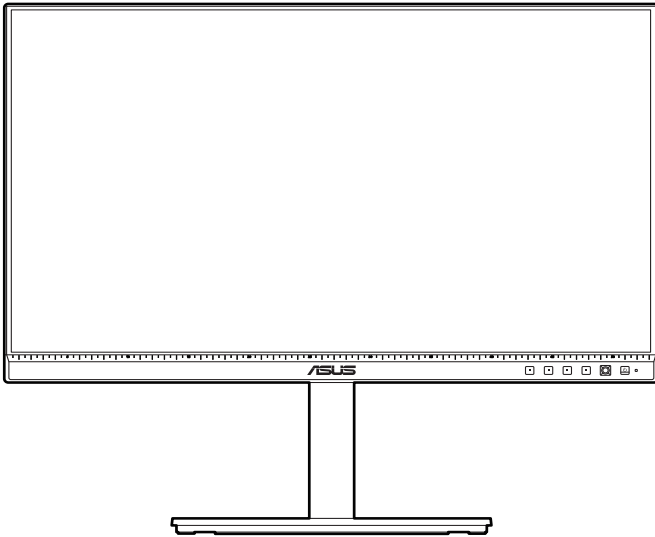

HDMI[™]
HIGH-DEFINITION MULTIMEDIA INTERFACE

First Edition

October 2022

Copyright © 2022 ASUSTeK COMPUTER INC. All Rights Reserved.

No part of this manual, including the products and software described in it, may be reproduced, transmitted, transcribed, stored in a retrieval system, or translated into any language in any form or by any means, except documentation kept by the purchaser for backup purposes, without the express written permission of ASUSTeK COMPUTER INC. ("ASUS").

Product warranty or service will not be extended if: (1) the product is repaired, modified or altered, unless such repair, modification or alteration is authorized in writing by ASUS; or (2) the serial number of the product is defaced or missing.

ASUS PROVIDES THIS MANUAL "AS IS" WITHOUT WARRANTY OF ANY KIND, EITHER EXPRESS OR IMPLIED, INCLUDING BUT NOT LIMITED TO THE IMPLIED WARRANTIES OR CONDITIONS OF MERCHANTABILITY OR FITNESS FOR A PARTICULAR PURPOSE. IN NO EVENT SHALL ASUS, ITS DIRECTORS, OFFICERS, EMPLOYEES OR AGENTS BE LIABLE FOR ANY INDIRECT, SPECIAL, INCIDENTAL, OR CONSEQUENTIAL DAMAGES (INCLUDING DAMAGES FOR LOSS OF PROFITS, LOSS OF BUSINESS, LOSS OF USE OR DATA, INTERRUPTION OF BUSINESS AND THE LIKE), EVEN IF ASUS HAS BEEN ADVISED OF THE POSSIBILITY OF SUCH DAMAGES ARISING FROM ANY DEFECT OR ERROR IN THIS MANUAL OR PRODUCT.

SPECIFICATIONS AND INFORMATION CONTAINED IN THIS MANUAL ARE FURNISHED FOR INFORMATIONAL USE ONLY, AND ARE SUBJECT TO CHANGE AT ANY TIME WITHOUT NOTICE, AND SHOULD NOT BE CONSTRUED AS A COMMITMENT BY ASUS. ASUS ASSUMES NO RESPONSIBILITY OR LIABILITY FOR ANY ERRORS OR INACCURACIES THAT MAY APPEAR IN THIS MANUAL, INCLUDING THE PRODUCTS AND SOFTWARE DESCRIBED IN IT.

Products and corporate names appearing in this manual may or may not be registered trademarks or copyrights of their respective companies, and are used only for identification or explanation and to the owners' benefit, without intent to infringe.

Contents

Contents	iii
Notices	iv
TCO certified	vi
Safety information	vii
Care & Cleaning	viii
Takeback Services	ix
Product information for EU energy label	ix
Chapter 1: Product introduction	
1.1 Welcome!	1-1
1.2 Package contents	1-1
1.3 Monitor introduction	1-2
1.3.1 Front view	1-2
1.3.2 Back view	1-3
1.3.3 Other Function(s)	1-4
Chapter 2: Setup	
2.1 Assembling the monitor arm/base	2-1
2.2 Detaching the arm/base (for VESA wall mount)	2-2
2.3 Attaching/Removing the MiniPC Kit	2-3
2.4 Adjusting the monitor	2-4
2.5 Connecting the cables	2-5
2.6 Turning on the monitor	2-6
2.7 Touch operation	2-6
Chapter 3: General instructions	
3.1 OSD (On-Screen Display) menu	3-1
3.1.1 How to reconfigure	3-1
3.1.2 OSD function introduction	3-2
3.2 Specifications summary	3-10
3.3 Outline dimensions	3-12
3.4 Troubleshooting (FAQ)	3-13
3.5 Supported operating modes	3-14

Notices

Federal Communications Commission Statement

This device complies with Part 15 of the FCC Rules. Operation is subject to the following two conditions:

- This device may not cause harmful interference, and
- This device must accept any interference received including interference that may cause undesired operation.

This equipment has been tested and found to comply with the limits for a Class B digital device, pursuant to Part 15 of the FCC Rules. These limits are designed to provide reasonable protection against harmful interference in a residential installation. This equipment generates, uses and can radiate radio frequency energy and, if not installed and used in accordance with the instructions, may cause harmful interference to radio communications. However, there is no guarantee that interference will not occur in a particular installation. If this equipment does cause harmful interference to radio or television reception, which can be determined by turning the equipment off and on, the user is encouraged to try to correct the interference by one or more of the following measures:

- Reorient or relocate the receiving antenna.
- Increase the separation between the equipment and receiver.
- Connect the equipment into an outlet on a circuit different from that to which the receiver is connected.
- Consult the dealer or an experienced radio/TV technician for help.



The use of shielded cables for connection of the monitor to the graphics card is required to assure compliance with FCC regulations. Changes or modifications to this unit not expressly approved by the party responsible for compliance could void the user's authority to operate this equipment.

ENERGY STAR complied product



ENERGY STAR is a joint program of the U.S. Environmental Protection Agency and the U.S. Department of Energy helping us all save money and protect the environment through energy efficient products and practices.

All ASUS products with the ENERGY STAR logo comply with the ENERGY STAR standard, and the power management feature is enabled by default. The monitor and computer are automatically set to sleep after 10 and 30 minutes of user inactivity. To wake your computer, click the mouse or press any key on the keyboard. Please visit <http://www.energystar.gov/powermanagement> for detail information on power management and its benefits to the environment. In addition, please visit <http://www.energystar.gov> for detail information on the ENERGY STAR joint program.



NOTE: Energy Star is NOT supported on FreeDOS and Linux-based operating system.

Canadian Department of Communications Statement

This digital apparatus does not exceed the Class B limits for radio noise emissions from digital apparatus set out in the Radio Interference Regulations of the Canadian Department of Communications.

This class B digital apparatus complies with Canadian ICES-003.

This Class B digital apparatus meets all requirements of the Canadian Interference - Causing Equipment Regulations.

Cet appareil numérique de la classe B respecte toutes les exigences du Règlement sur le matériel brouiller du Canada.



TCO certified

A third-party certification according to ISO 14024



Toward sustainable IT products

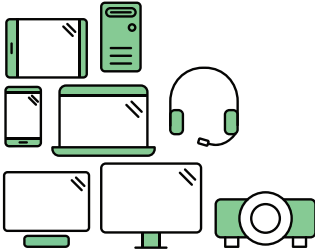

Say hello to a more sustainable product

IT products are associated with a wide range of sustainability risks throughout their life cycle. Human rights violations are common in the factories. Harmful substances are used both in products and their manufacture. Products can often have a short lifespan because of poor ergonomics, low quality and when they are not able to be repaired or upgraded.

This product is a better choice. It meets all the criteria in TCO Certified, the world's most comprehensive sustainability certification for IT products. Thank you for making a responsible product choice, that help drive progress towards a more sustainable future!

Criteria in TCO Certified have a life-cycle perspective and balance environmental and social responsibility. Conformity is verified by independent and approved verifiers that specialize in IT products, social responsibility or other sustainability issues. Verification is done both before and after the certificate is issued, covering the entire validity period. The process also includes ensuring that corrective actions are implemented in all cases of factory non-conformities. And last but not least, to make sure that the certification and independent verification is accurate, both TCO Certified and the verifiers are reviewed regularly.

Want to know more?

Read information about TCO Certified, full criteria documents, news and updates at tcocertified.com. On the website you'll also find our Product Finder, which presents a complete, searchable listing of certified products.

Safety information

- Before setting up the monitor, carefully read all the documentation that came with the package.
- To prevent fire or shock hazard, never expose the monitor to rain or moisture.
- Never try to open the monitor cabinet. The dangerous high voltages inside the monitor may result in serious physical injury.
- If the power supply is broken, do not try to fix it by yourself. Contact a qualified service technician or your retailer.
- Before using the product, make sure all cables are correctly connected and the power cables are not damaged. If you detect any damage, contact your dealer immediately.
- Slots and openings on the back or top of the cabinet are provided for ventilation. Do not block these slots. Never place this product near or over a radiator or heat source unless proper ventilation is provided.
- The monitor should be operated only from the type of power source indicated on the label. If you are not sure of the type of power supply to your home, consult your dealer or local power company.
- Use the appropriate power plug which complies with your local power standard.
- Do not overload power strips and extension cords. Overloading can result in fire or electric shock.
- Avoid dust, humidity, and temperature extremes. Do not place the monitor in any area where it may become wet. Place the monitor on a stable surface.
- Unplug the unit during a lightning storm or if it will not be used for a long period of time. This will protect the monitor from damage due to power surges.
- Never push objects or spill liquid of any kind into the slots on the monitor cabinet.
- To ensure satisfactory operation, use the monitor only with UL listed computers which have appropriate configured receptacles marked between 100-240V AC.
- If you encounter technical problems with the monitor, contact a qualified service technician or your retailer.
- Adjustment of the volume control as well as the equalizer to other settings than the center position may increase the ear-/headphones output voltage and therefore the sound pressure level.
- Ensure to connect the power cord to a socket-outlet with earthing connection.



This symbol of the crossed out wheeled bin indicates that the product (electrical, electronic equipment, and mercury-containing button cell battery) should not be placed in municipal waste. Please check local regulations for disposal of electronic products.

Care & Cleaning

- Before you lift or reposition your monitor, it is better to disconnect the cables and power cord. Follow the correct lifting techniques when positioning the monitor. When lifting or carrying the monitor, grasp the edges of the monitor. Do not lift the display by the stand or the cord.
- Cleaning. Turn your monitor off and unplug the power cord. Clean the monitor surface with a lint-free, non-abrasive cloth. Stubborn stains may be removed with a cloth dampened with mild cleaner.
- Avoid using a cleaner containing alcohol or acetone. Use a cleaner intended for use with the monitor. Never spray cleaner directly on the screen, as it may drip inside the monitor and cause an electric shock.

The following symptoms are normal with the monitor:

- You may find slightly uneven brightness on the screen depending on the desktop pattern you use.
- When the same image is displayed for hours, an afterimage of the previous screen may remain after switching the image. The screen will recover slowly or you can turn off the Power Switch for hours.
- When the screen becomes black or flashes, or cannot work anymore, contact your dealer or service center to fix it. Do not repair the screen by yourself!

Conventions used in this guide



WARNING: Information to prevent injury to yourself when trying to complete a task.



CAUTION: Information to prevent damage to the components when trying to complete a task.



IMPORTANT: Information that you **MUST** follow to complete a task.



NOTE: Tips and additional information to aid in completing a task.

Where to find more information

Refer to the following sources for additional information and for product and software updates.

1. ASUS websites

The ASUS websites worldwide provide updated information on ASUS hardware and software products. Refer to <http://www.asus.com>

2. Optional documentation

Your product package may include optional documentation that may have been added by your dealer. These documents are not part of the standard package.

3. About Flicker

https://www.asus.com/Microsite/display/eye_care_technology/

Takeback Services

ASUS recycling and takeback programs come from our commitment to the highest standards for protecting our environment. We believe in providing solutions for our customers to be able to responsibly recycle our products, batteries and other components as well as the packaging materials.

Please go to <http://csr.asus.com/english/Takeback.htm> for detail recycling information in different region.

Product information for EU energy label



BE24ECSBT

1.1 Welcome!

Thank you for purchasing the ASUS® LCD monitor!

The latest widescreen LCD monitor from ASUS provides a broader, brighter and crystal-clear display, plus a host of features that enhance your viewing experience.

With these features, you can enjoy the convenience and delightful visual experience that the monitor brings to you!

1.2 Package contents

Check your package for the following items:

- ✓ LCD monitor
- ✓ Monitor base
- ✓ Quick start guide
- ✓ Warranty card
- ✓ Power cord
- ✓ HDMI cable (optional)
- ✓ DisplayPort cable (optional)
- ✓ USB C to A cable (optional)
- ✓ USB C to C cable (optional)
- ✓ MiniPC Kit (optional)



If any of the above items is damaged or missing, contact your retailer immediately.



If you need to replace the power cord or the connection cable(s), please contact ASUS customer service.



1.3 Monitor introduction

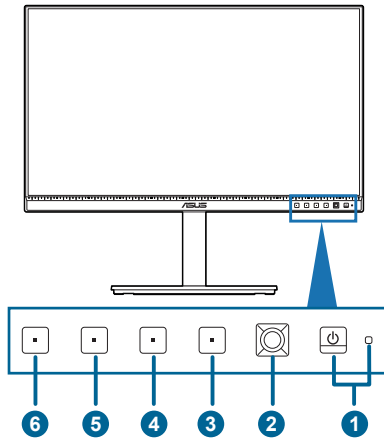

1.3.1 Front view



1.  Power button/power indicator
 - Turns the monitor on/off.
 - The color definition of the power indicator is as the below table.

Status	Description
White	On
Amber	Standby mode
Off	Off

2.  5-way button:
 - To display the OSD menu when the OSD is off.
 - To enact the selected OSD menu items.
 - To increase/decrease values or move your selection up/down/left/right.
3.  Close button:
 - Press this button to display the OSD menu when the OSD is off.
 - Exits the OSD menu.
 - Toggles the Key Lock function between on and off with a long press for 5 seconds.
4.  Input Select button:
 - Press this button to display the OSD menu when the OSD is off.
 - This is a hotkey for you to select an available input source.

5.  **Shortcut 1**
 - Press this button to display the OSD menu when the OSD is off.
 - Default: Brightness hotkey
 - To change the hotkey function, go to the Shortcut > Shortcut 1 menu.
6.  **Shortcut 2**
 - Press this button to display the OSD menu when the OSD is off.
 - Default: Touch Function hotkey
 - To change the hotkey function, go to the Shortcut > Shortcut 2 menu.

1.3.2 Back view

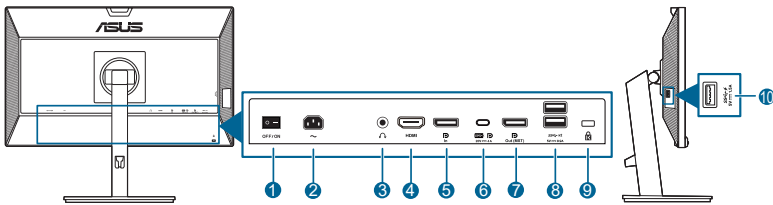

1. **Power switch.** Press the switch to turn on/off power.
2. **AC-IN port.** This port connects the power cord.
3. **Earphone jack.** This port is only available when an HDMI/DisplayPort/USB Type-C cable is connected.
4. **HDMI port.** This port is for connection with an HDMI compatible device.
5. **DisplayPort in.** This port is for connection with a DisplayPort compatible device.
6. **USB 3.2 Gen1 Type-C.** This port is for connection with a USB upstream cable. The connection supports USB power and data delivery.



This monitor is Super-Speed USB 3.2 Gen1 compatible (5Gbps). The port offers Max. 80W power delivery with output voltage 5V/3A, 9V/3A, 12V/3A, 15V/3A and 20V/4A. Connecting the USB Type-C cable can input the DisplayPort source, output power and enable the USB Type-A ports (downstream) on the monitor. Connecting the USB Type-C to Type-A cable only enables the USB Type-A ports (downstream) on the monitor.

7. **Daisy-Chain DisplayPort output.** This port allows you to connect multiple DisplayPort compatible monitors.
8. **USB 3.2 Gen1 Type A.** These ports are for connection with USB devices, such as USB keyboard/mouse, USB flash drive, etc.
9. **Kensington lock slot.**

2.1 Assembling the monitor arm/base

To assemble the monitor base:

1. Have the front of the monitor face down on a table.
2. Place the arm hinge of the stand assembly onto its compartment on the rear of the monitor.
3. Attach the base into the arm, making sure the tab on the arm fits into the groove on the base.
4. Fix the base to the arm by fastening the bundled screw.



We recommend that you cover the table surface with soft cloth to prevent damage to the monitor.

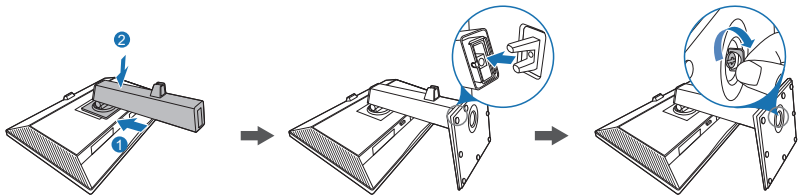

Base screw size: M6 x 16.5 mm.

2.2 Detaching the arm/base (for VESA wall mount)

The detachable arm/base of this monitor is specially designed for VESA wall mount.

To detach the arm/base:

1. Have the front of the monitor face down on a table.
2. Press the release button, and then detach the arm/base from the monitor.

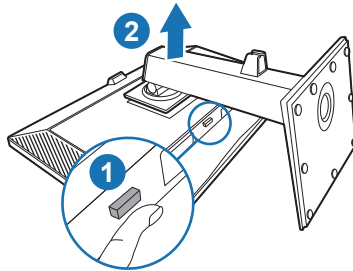

We recommend that you cover the table surface with soft cloth to prevent damage to the monitor.



- The VESA wall mount kit (100 x 100 mm) is purchased separately.
 - Use only the UL Listed Wall Mount Bracket with minimum weight/load 22.7kg (Screw size: M4 x 10 mm)
-

2.3 Attaching/Removing the MiniPC Kit

Attaching the MiniPC Kit

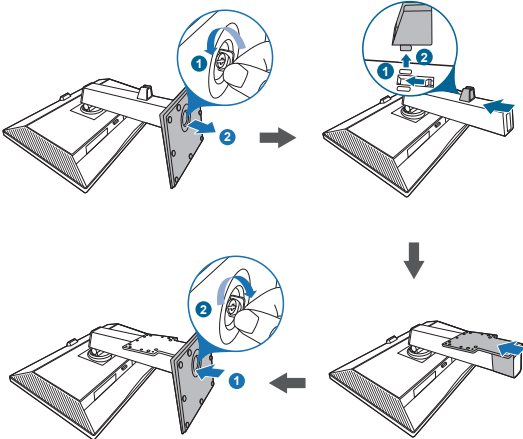

Removing the MiniPC Kit

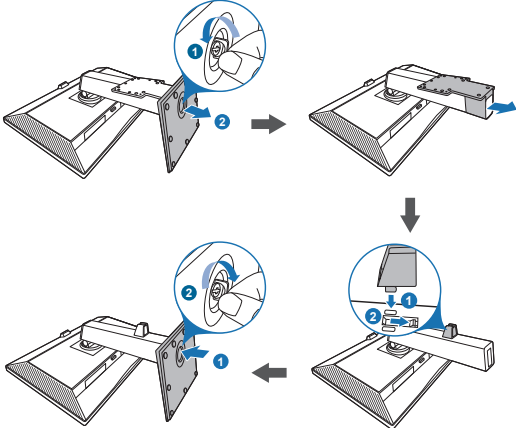

2.4 Adjusting the monitor

- For optimal viewing, we recommend that you look at the full face of the monitor, then adjust the monitor to the angle that is most comfortable for you.
- Hold the stand to prevent the monitor from falling when you change its angle.
- You can adjust the monitor's angle from +35° to -5° and it allows 180° swivel adjustment (by removing the stop screw) from either left or right. You can also adjust the monitor's height within +/- 130 mm.

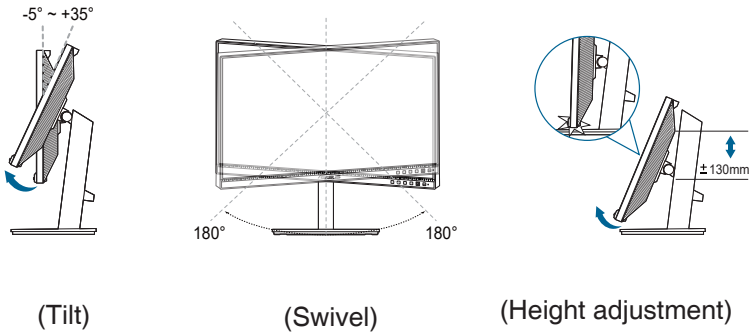

Pivoting the monitor

1. Lift the monitor to the highest position.
2. Tilt the monitor to its maximum angle.
3. Pivot the monitor clockwise/counterclockwise to the angle you need.

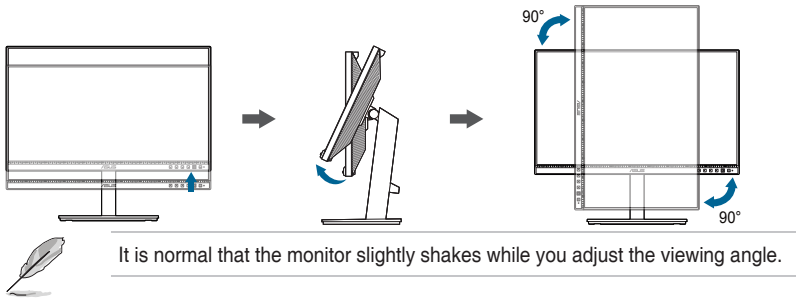

2.5 Connecting the cables

Connect the cables as the following instructions:

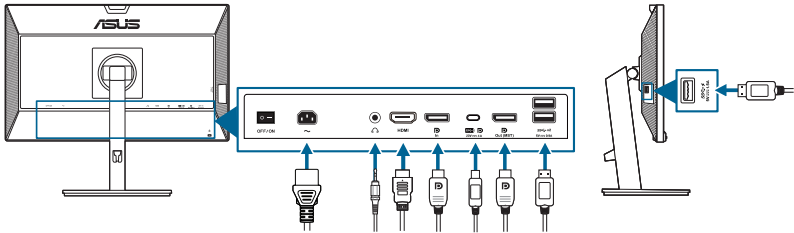

- **To connect the power cord:** Connect one end of the power cord securely to the monitor's AC input port, the other end to a power outlet.
- **To connect the DisplayPort/HDMI/USB Type-C* cable:**
 - a. Plug one end of the DisplayPort/HDMI/USB Type-C* cable to the monitor's DisplayPort/HDMI/USB Type-C jack.
 - b. Connect the other end of the DisplayPort/HDMI/USB Type-C* cable to your computer's DisplayPort/HDMI/USB Type-C jack.



It is suggested to use USB certified Type-C cable. If the signal source supports DP Alt mode, all video, audio and data signal can be transmitted. USB Type-C cable needs to be connected for touch signal transmission.

- **To use the earphone:** connect the end with plug type to the monitor's earphone jack when an HDMI/DisplayPort/USB Type-C signal is fed.
- **To use the USB 3.2 Gen 1 ports:**
 - » Upstream: Use an USB Type-C cable and plug one end of the Type-C connector to the monitor's USB Type-C port (USB-C) as upstream and the other end to your computer's USB Type-C jack. Or use an USB Type-C to Type-A cable and plug the Type-C connector to the monitor's USB Type-C port (USB-C) as upstream and the Type-A connector to your computer's USB Type-A jack. Make sure your computer is installed with the latest Windows 7/Windows 10/Windows 11 operating system. That will enable the built-in webcam on the monitor to work.
 - » Downstream: Use an USB cable to connect your device with the monitor's USB Type A jack.





When these cables are connected, you can choose the desired signal from the Input Select item in the OSD menu.



If you need to replace the power cord or the connection cable(s), please contact ASUS customer service.

2.6 Turning on the monitor

Press the power button . See page 1-2 for the location of the power button. The power indicator  lights up in white to show that the monitor is ON.

2.7 Touch operation

This touch screen monitor uses 10-point touch panel technology. It is compatible with the latest operating systems such as Windows 11. You can use either single finger touch, or multi-finger touch up to maximum simultaneous 10 touch points.

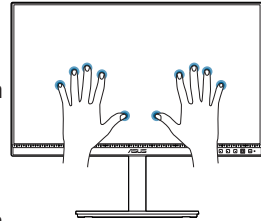

To activate touch functionality, all you need to do is connect the monitor with the provided USB Type-C cable to your computer, and turn on the Touch Function from the OSD menu. This monitor offers you groovy touch gestures like tap, grab, pinch, rotate, zoom, swipe, etc.



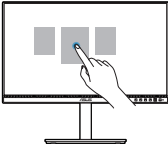
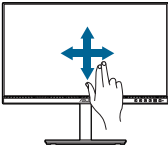
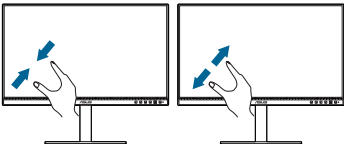
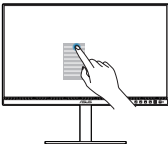



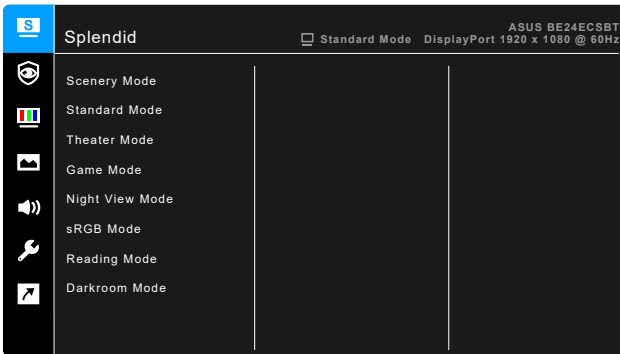

Touch gestures

Action		Gestures
Select an item	Tap the screen	
Scroll	Place two fingers on the screen and slide horizontally or vertically	
Zoom in or out	Place two fingers on the screen and pinch in or stretch out	
Show more commands (like right-clicking)	Press and hold the item for 3 seconds	

3.1 OSD (On-Screen Display) menu

3.1.1 How to reconfigure



1. Press the  5-way button to activate the OSD menu.
2. Move the  5-way button up/down/left/right to navigate through the functions. Highlight the desired function and press the  5-way button to activate it. If the function selected has a sub-menu, move the  5-way button up/down to navigate through the sub-menu functions. Highlight the desired sub-menu function and press the  5-way button or move the  5-way button to activate it.
3. Move the  5-way button up/down to change the settings of the selected function.
4. To exit and save the OSD menu, press the **X** button or move the  5-way left repeatedly until the OSD menu disappears. To adjust other functions, repeat steps 1-3.



When USB Type-C port is connected and power delivery is enabled, the status of power delivery will be shown on the top right corner of OSD menu. Please note that the tolerance is within +/-20%.

3.1.2 OSD function introduction

1. Splendid

This function contains 8 sub-functions you can select for your preference. Each mode has the Reset selection, allowing you to maintain your setting or return to the preset mode.

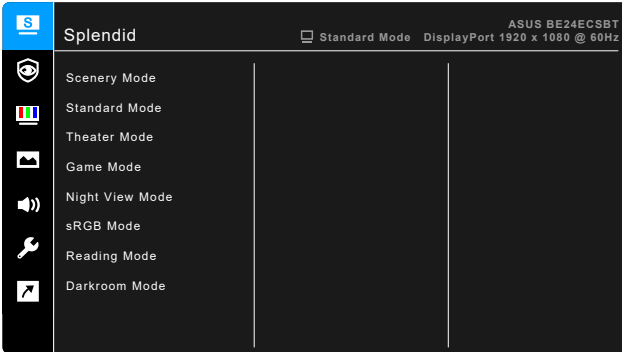

- **Scenery Mode:** Best choice for scenery photo display with Splendid Video Enhancement.
- **Standard Mode:** Best choice for document editing with Splendid Video Enhancement.
- **Theater Mode:** Best choice for movies with Splendid Video Enhancement.
- **Game Mode:** Best choice for games playing with Splendid Video Enhancement.
- **Night View Mode:** Best choice for dark-scene games or movies with Splendid Video Enhancement.
- **sRGB Mode:** best choice for viewing photos and graphics from PCs.



sRGB Mode meets Energy Star® requirements.

- **Reading Mode:** This is the best choice for book reading.
- **Darkroom Mode:** This is the best choice for a weak ambient light environment.



-
- In the Standard mode, the following function(s) are not user-configurable: Saturation, Skin Tone, Sharpness, ASCR.
 - In the sRGB mode, the following function(s) are not user-configurable: Brightness, Contrast, Saturation, Color Temp., Skin Tone, Sharpness, ASCR.
 - In the Reading mode, the following function(s) are not user-configurable: Contrast, Saturation, Color Temp., Skin Tone, ASCR.
-

2. Eye Care

In this function, you can adjust settings to better protect your eyes.

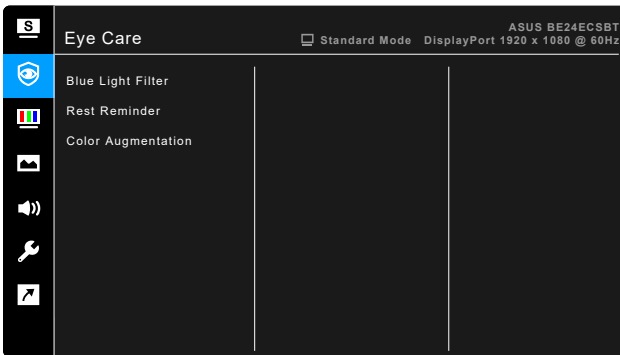

- **Blue Light Filter:** In this function, you can adjust the blue light filter from 0 to Max.
 - * 0: No change.
 - * Max: The higher the level, the less blue light is scattered. When blue light filter is activated, the default settings of Standard Mode will be automatically imported. Besides maximum level, the brightness is user-configurable. Maximum is the optimized setting. It is in compliance with TUV low blue light certification*. The brightness function is not user configurable.



*When color augmentation is in default value (50).



Please refer to the following to alleviate eye strains:

- Users should take some time away from the display if working for long hours. It is advised to take short breaks (at least 5 mins) after around 1 hour of continuous working at the computer. Taking short and frequent breaks is more effective than a single longer break.
- To minimize eye strain and dryness in your eyes, users should rest the eye periodically by focusing on objects that are far away.
- Eye exercises can help to reduce eye strain. Repeat these exercises often. If eye strain continues please consult a physician. Eye exercises: (1) Repeating look up and down (2) Slowly roll your eyes (3) Move your eyes diagonal.
- High energy blue light may lead to eye strain and AMD (Age-Related Macular Degeneration). Blue light filter to reduce 70% (max.) harmful blue light to avoiding CVS (Computer Vision Syndrome) when the user adjusts blue light filter bar to maximum level.

-
- **Rest Reminder:** This function provides you a rest reminder according to how long you set for your working time. For example, if you set a 30-minute working time and there will be a pop up reminder appeared on the upper left corner of the monitor for 5 seconds when time is up. Press any key to make this reminder OSD disappear.



When this function is enabled, the following functions are not available: Splendid Demo Mode, GamePlus, QuickFit.

- **Color Augmentation:** The adjusting range of color enhancement is from 0 to 100.



-
- This function is not available when sRGB Mode is selected in the Splendid menu.
 - This function is not available when Reddish or Yellowish is selected in the Skin Tone menu.
-

3. Color

Set a desired color setting from this menu.

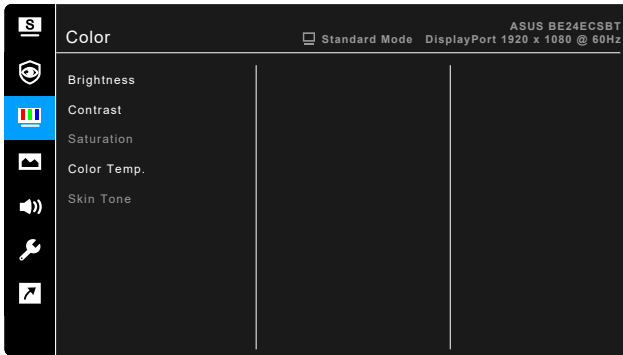

- **Brightness:** The adjusting range is from 0 to 100.
- **Contrast:** The adjusting range is from 0 to 100.
- **Saturation:** The adjusting range is from 0 to 100.
- **Color Temp.:** Contains 4 modes including Cool, Normal, Warm and User Mode.
- **Skin Tone:** contains three color modes including Reddish, Natural, and Yellowish.

4. Image

Set the image related setting from this menu.

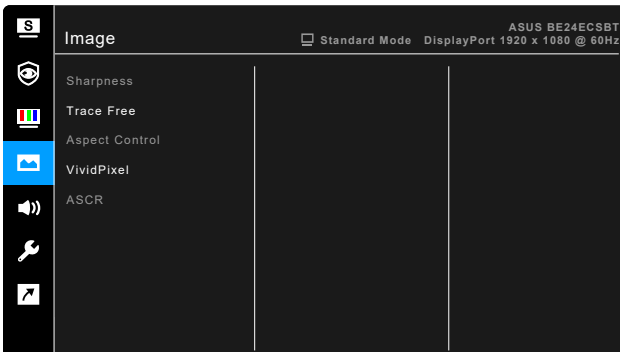

- **Sharpness:** The adjusting range is from 0 to 100.
- **Trace Free:** Adjusts the response time of the monitor.

- **Aspect Control:** Adjusts the aspect ratio to full, 4:3, 1:1 (optional) or OverScan (optional).



4:3 is only available when input source is in 4:3 format. OverScan is only available for the HDMI input source.

- **VividPixel:** Enhances the outline of the displayed picture and generates high-quality images on screen.
- **ASCR:** Turns on/off the ASCR (ASUS Smart Contrast Ratio) function.

5. Sound

You can adjust Volume, Mute and Source from this menu.

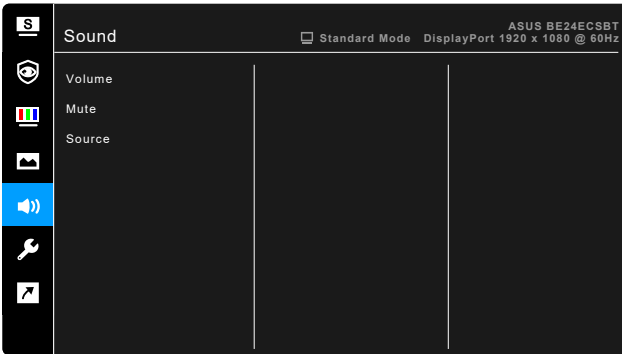

- **Volume:** the adjusting range is from 0 to 100.
- **Mute:** toggles the monitor sound between on and off.
- **Source:** decides the monitor sound comes from which source.

6. System Setup

Allows you to adjust the system.

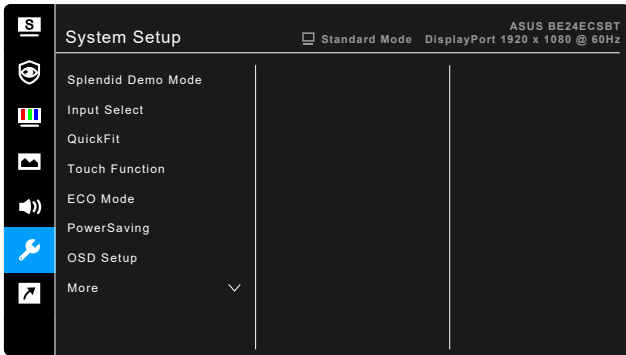

- **Splendid Demo Mode:** Splits the screen into two for Splendid modes comparison. (Scenery mode only)
- **Input Select:** You can select your desired input source.
- **QuickFit:** You can have a preview of the document or photo layout directly on screen without printing test copies.
 - * Grid pattern: This facilitates designers and users to organize content and layout on one page and achieve a consistent look and feel.

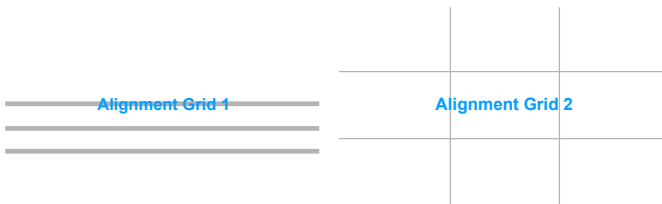

- * **Paper size:** You can view the documents in real size on the screen.

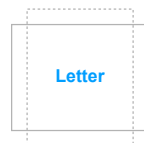

- * **Photo:** The various real photo sizes displayed in the QuickFit function provides photographers and other users to accurately view and edit their photos in real size on the screen.



- **Touch Function:** To enable or disable the touch function.
- **ECO Mode:** reduces power consumption.
- **PowerSaving:**
 - * “Normal Level” allows the USB downstream ports/USB Type-C ports to charge external devices when the monitor enters power saving mode.
 - * “Deep Level” does not allow all ports to charge external devices and keeps USB signal from being automatically detected when the monitor enters power saving mode.
- **OSD Setup:**
 - * Adjusts the OSD timeout from 10 to 120 seconds.
 - * Enables or disables the DDC/CI function.
 - * Adjusts the OSD background from opaque to transparent.
- **Language:** There are 22 languages for your selection, including English, French, German, Italian, Spanish, Dutch, Portuguese, Russian, Czech, Croatian, Polish, Romanian, Hungarian, Turkish, Simplified Chinese, Traditional Chinese, Japanese, Korean, Thai, Indonesian, Persian, Ukrainian.
- **DisplayPort Stream:** Compatibility with graphic card. Select DisplayPort 1.1 or DisplayPort 1.4 by graphic card DP version.
- **Key Lock:** To disable all function keys. Press the third button from the right over five seconds to cancel the key lock function.
- **Information:** Shows the monitor information.
- **Power Indicator:** Turns the power LED indicator on/off.
- **Ambient Effect:** Synchronizes display brightness with ambient light changes.
- **Power Key Lock:** Enables or disables the power key.
- **All Reset:** “Yes” allows you to restore the default settings.

7. Shortcut

Defines the function for the Shortcut button.

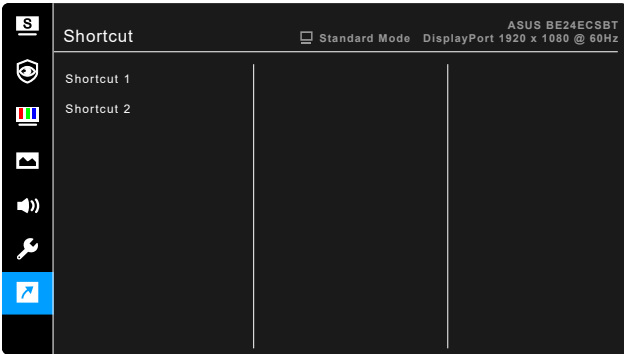

- **Shortcut** : Selects a function for the Shortcut button.



When a certain function is selected or activated, your shortcut key may not support. Available function choices for shortcut: Blue Light Filter, Splendid, Brightness, Contrast, Color Temp., Touch Function.

3.2 Specifications summary

Panel Type	TFT LCD
Panel size	23.8" (16:9, 60.47 cm) wide screen
Max. Resolution	1920 x 1080
Pixel pitch	0.2745 mm x 0.2745 mm
Brightness (Typ.)	300 cd/m ²
Contrast Ratio (Typ.)	1000:1
Contrast Ratio (Max.)	100,000,000:1 (with ASCR on)
Viewing angle (H/V) CR>10	178°/178°
Display colors	16.7 M
Response time	≤ 5 ms
Splendid Video Enhancement	Yes
Splendid selection	8 video preset modes
Color temperature selection	4 color temperatures
Signal input	DisplayPort v1.4, HDMI v1.4, DisplayPort over USB Type C
Signal Output	DisplayPort v1.4
Earphone jack	Yes
Audio input	Yes (DisplayPort, HDMI, USB Type-C)
Speaker (Built-in)	2 W x 2 Stereo, RMS
USB 3.2 Gen 1 port	1 x USB 3.2 Gen 1 Type-C, 3 x USB 3.2 Gen 1 Type-A
Ethernet port	No
Colors	Black
Power LED	White (On)/Amber (Standby)
Tilt	+35° ~ -5°
Pivot	+90° ~ -90°
Swivel	+180° ~ -180°
Height Adjustment	130 mm
Kensington lock	Yes
AC input voltage	AC: 100~240V
Power consumption	Power On: < 17.7 W** (Typ.), Standby: < 0.5 W (Typ.), Power Off: 0 W (Switch off)
Temperature (Operating)	0°C~40°C
Temperature (Non-operating)	-20°C~+60°C
Dimension (W x H x D) without stand	539.7 x 329.9 x 52.8 mm
Dimension (W x H x D) with stand	539.7 x 459.4 x 211.4 mm (highest), 539.7 x 329.4 x 211.4 mm (lowest), 746.0 x 440.0 x 170.0 mm (package)
Weight (Esti.)	6.1 kg (Net); 4.1 kg (Without stand); 8.3 kg (Gross)

Multi-languages	22 languages (English, French, German, Italian, Spanish, Dutch, Portuguese, Russian, Czech, Croatian, Polish, Romanian, Hungarian, Turkish, Simplified Chinese, Traditional Chinese, Japanese, Korean, Thai, Indonesian, Persian, Ukrainian)
Accessories	Quick start guide, warranty card, power cord, HDMI cable (optional), DisplayPort cable (optional), USB C to A cable (optional), USB C to C cable (optional), MiniPC Kit (optional)
Compliance and Standards	UL/cUL, CB, CE, ErP, EU Energy label, FCC, ICES-3, CCC, CEL, ISO9241-307, TUV-GS, TUV-ERGO, BSMI, CU, C-Tick, MEPS, VCCI, PSE, J-MOSS, KC, KCC, e-Standby, RoHS, Windows 10&11 WHQL, Energy Star 8.0, EPEAT Silver, TCO9.0, Flicker Free, Low Blue Light, WEEE, NFPA 99, CECP

*Specifications are subject to change without notice.

**Measuring a screen brightness of 300 nits without audio/USB/Card reader connection.

3.3 Outline dimensions

ASUS BE24ECBT Outline Dimension
 * Unit: mm(inch)

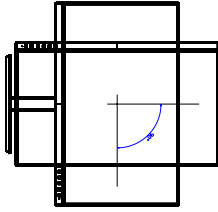

Pivot: +/-90 Degree

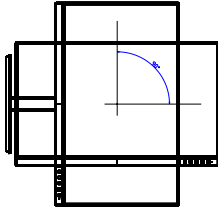

Tilt: -5~35 Degree

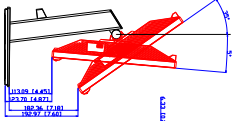

Swivel: +/-180 Degree

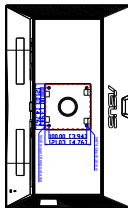
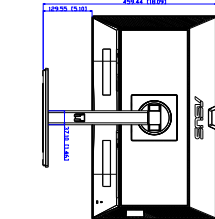
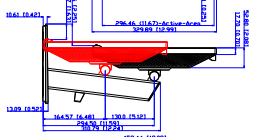
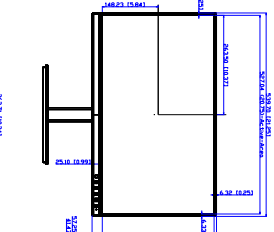
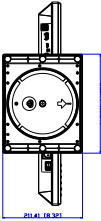
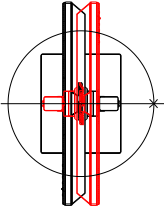

3.4 Troubleshooting (FAQ)

Problem	Possible Solution
Power LED is not ON	<ul style="list-style-type: none"> • Press the  button to check if the monitor is in the ON mode. • Check if the power cord is properly connected to the monitor and the power outlet. • Check if the power switch is ON.
The power LED lights amber and there is no screen image	<ul style="list-style-type: none"> • Check if the monitor and the computer are in the ON mode. • Make sure the signal cable is properly connected the monitor and the computer. • Inspect the signal cable and make sure none of the pins are bent. • Connect the computer with another available monitor to check if the computer is properly working.
Screen image is too light or dark	<ul style="list-style-type: none"> • Adjust the Contrast and Brightness settings via OSD.
Screen image bounces or a wave pattern is present in the image	<ul style="list-style-type: none"> • Make sure the signal cable is properly connected to the monitor and the computer. • Move electrical devices that may cause electrical interference.
Screen image has color defects (white does not look white)	<ul style="list-style-type: none"> • Inspect the signal cable and make sure that none of the pins are bent. • Perform All Reset via OSD. • Adjust the R/G/B color settings or select the Color Temperature via OSD.
Screen image is blurry or fuzzy	<ul style="list-style-type: none"> • Adjust the Phase and Clock settings via OSD.
No sound or sound is low	<ul style="list-style-type: none"> • Ensure that the HDMI/DisplayPort/USB Type-C cable is properly connected to the monitor and the computer. • Adjust the volume settings of both your monitor and HDMI/DisplayPort/USB Type-C device. • Ensure that the computer sound card driver is properly installed and activated.

3.5 Supported operating modes

Resolution Frequency	Horizontal Frequency (KHz)	Vertical Frequency (Hz)	Pixel (MHz)
640 x 480	31.47(N)	59.94(N)	25.18
640 x 480	35.00(N)	66.66(N)	30.24
640 x 480	37.87(N)	72.82(N)	31.5
640 x 480	37.5(N)	75.00(N)	31.5
720 x 400	31.47(N)	70.08(P)	28.32
800 x 600	35.16(P)	56.25(P)	36
800 x 600	37.88(P)	60.32(P)	40
800 x 600*	48.08(P)	72.12(P)	50
800 x 600	46.86(P)	75.00(P)	49.5
832 x 624	49.72(P/N)	74.55(P/N)	57.28
1024 x 768	48.36(N)	60.00(N)	65
1024 x 768	56.476(N)	70.069(N)	75
1024 x 768	60.02(N)	75.00(N)	78.75
1152 x 864	67.5(P/N)	75.00(P/N)	108
1280 x 720	45.00(P)	60.00(N)	75.25
1280 x 768	47.78(P)	60.00(N)	79.5
1280 x 800	49.7(P)	60.00(N)	83.5
1280 x 960	60.00(P)	60.00(N)	108
1280 x 1024	63.98(P)	60.02(N)	108
1280 x 1024	79.98(P)	75.02(N)	135
1360 x 768	47.712(P)	59.79(P)	85.5
1366 x 768	47.712(P)	59.79(P)	85.5
1440 x 900	55.94(N)	59.89(P)	106.5
1600 x 1200	75.00(P)	60.00(P)	162
1680 x 1050	65.29(P)	60.00(P)	146.25
1920 x 1080	67.5(P)	60.00(P)	148.5
1920 x 1080	83.89(N)	74.97(P)	174.5

“P” / “N” stands for “Positive” / “Negative” polarity of incoming H-sync/V-sync (input timing).

*Not supported when using the Overscan function.

When the monitor is operating in the video mode (ie, not displaying data), the following high definition modes shall be supported in addition to standard definition video.

Timing Name	Pixel Format	Horizontal Frequency (kHz)	Vertical Frequency (Hz)	Pixel Rate (MHz)
480p	720 x 480	31.469	60	27
720p60	1280 x 720	45	60	74.25
576p	720 x 576	31.25	50	27
720p50	1280 x 720	37.5	50	74.25
1080p60	1920 x 1080	67.5	60	148.5
1080p50	1920 x 1080	56.25	50	148.5