

# SAMSUNG KIOSK User Manual

---

KMC-W (KM24C-3, KM24C-C, KM24C-5)

The colour and the appearance may differ depending on the product, and the content in the manual is subject to change without prior notice to improve the performance.

Recommended hours of use per day of this product is under 16 hours. If the product is used for longer than 16 hours a day, the warranty may be void.

An administration fee may be charged in the following situations:

- (a) An engineer is called out at your request, but it is found that the product has no defect (i.e., where the user manual has not been read).
- (b) You bring the unit to a repair centre, but it is found that the product has no defect (i.e., where the user manual has not been read).

You will be informed of the administration fee amount before a technician visits.

# Table of contents

## Before using the product

Safety precautions	3
Safety symbols	3
Electricity and safety	4
Installation	5
Operation	7
Cleaning	9
Data precautions	10
Operating system and software support	10
Product capacity representation	10
Storage capacity representation	10
Memory capacity representation	10

## Preparations

Checking the components	11
Display	11
Connection Box	12
Parts	13
Display	14
Ports	15
Display	15
Before Installing the Product (Installation Guide)	16
Ventilation	16

Installing the Wall Mount	17
Installing the Wall Mount	17
Wall Mount Kit Specifications (VESA)	17

## Basics

Touchscreen	18
Precautions when using the touchscreen	18
Tips on using the touchscreen	18
Touch screen gestures	19
Entering text	20
Window	22
About Windows Activation	22
Configuring the Windows Settings	22
Action Center	22
Unlocking the screen	22
Settings & Upgrade	23
Volume	23
BIOS (Setup utility)	23
Entering the BIOS	23
The BIOS screen	24
Boot priority	24

## Menu

Picture	25
Onscreen Display	26

Support	27
---------	----

## Troubleshooting Guide

Requirements Before Contacting Samsung Customer Service Centre	28
Check the followings.	28
Windows recovery function	31

## Specifications

General	32
---------	----

## Appendix

Responsibility for the Pay Service (Cost to Customers)	33
Not a product defect	33
A Product damage caused by customer's fault	33
Others	33
Prevention of Afterimage Burn-in	34
What is afterimage burn-in?	34
Recommended prevention practices	34
License	35





# Chapter 01







## Before using the product

### Safety precautions

The following safety instructions are to ensure your personal safety and prevent property damage. Please read the following to ensure the proper use of the product.

### Safety symbols

Symbol	Name	Meaning
	Warning	A serious or fatal injury may result if instructions are not followed.
	Caution	Personal injury or damage to properties may result if instructions are not followed.
	Prohibition	Do NOT attempt.
	Instruction	Follow directions.

CAUTION			
RISK OF ELECTRIC SHOCK. DO NOT OPEN.			
CAUTION: TO REDUCE THE RISK OF ELECTRIC SHOCK, DO NOT REMOVE COVER (OR BACK). THERE ARE NO USER SERVICEABLE PARTS INSIDE. REFER ALL SERVICING TO QUALIFIED PERSONNEL.			
	This symbol indicates that high voltage is present inside. It is dangerous to make any kind of contact with any internal part of this product.		AC voltage: Rated voltage marked with this symbol is AC voltage.
	This symbol indicates that this product has included important literature concerning operation and maintenance.		DC voltage: Rated voltage marked with this symbol is DC voltage.
	Class II product: This symbol indicates that a safety connection to electrical earth (ground) is not required. If this symbol is not present on a product with a mains lead, the product MUST have a reliable connection to protective earth (ground).		Caution. Consult instructions for use: This symbol instructs the user to consult the user manual for further safety related information.

## Electricity and safety

 The following images are for reference only. Real-life situations may differ from what is shown in the images.

### Warning





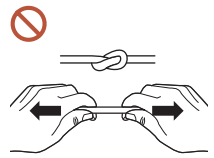

Do not touch the power plug with wet hands.  
Otherwise, an electric shock may result.

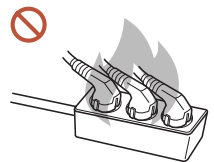

Do not bend or pull the power cable with force. Be careful not to leave the power cable under a heavy object.  
Product failure, an electric shock or fire may result from a damaged cable.



Do not connect multiple products to a single power socket.  
Overheated power sockets may cause a fire.

-  Insert the power plug all the way in so it is not loose.  
An unsecure connection may cause a fire.
-  Clean any dust around the pins of the power plug or the power socket with a dry cloth.  
A fire may result.
-  Connect the power plug to a grounded power socket. (Except for devices that do not provide grounding)  
An electric shock or injury may result.
-  Do not use a damaged power plug or a loose power socket.  
An electric shock or fire may result.

## Caution

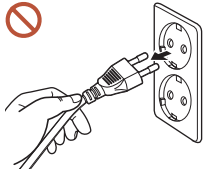

Hold the plug when disconnecting the power cable from the power socket.

An electric shock or fire may result.

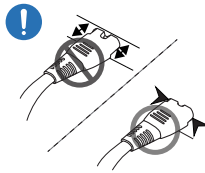

When connecting the power plug to the port, be sure to connect it completely.

If the power plug is not completely connected to the port, the plug may be unexpectedly disconnected, or there is a risk of overheating due to overcurrent, leading to safety accidents.

 Only use the power cable provided with your product by Samsung. Do not use the power cable with other products.

An electric shock or fire may result.

 Keep the power socket where the power cord is connected unobstructed.

When a problem occurs with the product, the power cord must be unplugged to completely cut off power to the product. Note that the product is not completely powered down by using only the power button on the remote.

 Do not disconnect the power cable while the product is being used.

The product may become damaged by an electric shock.

 You can only assemble the power strip provided with the kiosk. Using any other power strip cannot guarantee your safety.

 Plug the unused outlets in the power strip with the provided cover.

## Installation

### Warning



Before moving the product, turn off the power switch and disconnect the power cable and all other connected cables.

Damage to the cable may cause a fire or electric shock.

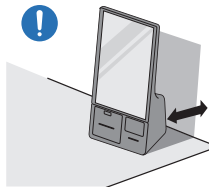

When installing the product, keep it at a distance from the wall so that it is well ventilated.

An increased internal temperature may cause a fire.



Do not install the product in a poorly ventilated space such as bookcase or closet.

An increased internal temperature may cause a fire.



Keep the plastic packaging out of the reach of children.

Children's misuse of the plastic packaging may cause suffocation.



**Do not install the power cable (DC power supply) and the product near heat sources.**

(Candles, mosquito repellents, cigarettes, sprays, heating devices, places exposed to direct sunlight(Except for Outdoor products), and more)



**When installing the product, fix it firmly so that it does not fall.**

If the product is not fixed firmly and a child touches the product while playing, the product may fall, causing damage to the product or injury to the child.



**Do not install the product in a kitchen or near a kitchen counter.**

Edible oil or oil vapor can damage or deform the product.

**! Have a technician install the wall-mount hanger.**

Installation by an unqualified person can result in an injury. Only use approved cabinets.

**! If the product is installed in an unusual location, the surrounding environment may cause a serious quality problem. Therefore, be sure to contact Samsung Customer Service Centre before installation.**

(Places where many fine dusts are generated, places where chemicals are used, places with too high or low temperatures, places with a lot of moisture or water, transportation equipment such as vehicles, airports and stations used continuously for a long time, and more)

**! Caution**



**Do not drop the product while moving.**

The product may fall, causing personal injury or product damage.

**! Do not lay down the product on its front.**  
The screen may become damaged.

**! Prolonged exposure to direct sunlight may discolour the surface of the screen display.**

## Operation

### Warning



If the product generates a strange noise, a burning smell, or smoke, unplug the power plug immediately and contact your Samsung Customer Service Centre.

An electric shock or fire may result.



Keep the remote control batteries and the small accessories out of the reach of children. Ensure children do not swallow any of them.

If children have had the battery in their mouths, consult your doctor immediately.



If the product is dropped or its appearance is damaged, turn off the power switch and disconnect the power cord. Then contact Samsung Customer Service Centre.

Continued use can result in an electric shock or a fire.



Do not move the product by pulling the power cord or any cable.

Product failure, an electric shock or fire may result from a damaged cable.



Ensure the vents are not blocked by tablecloths or curtains.

An increased internal temperature may cause a fire.



Do not apply an impact to the product.

- The screen display may be damaged.
- An electric shock or fire may result.

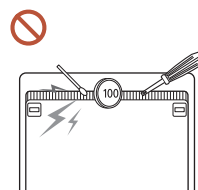

Do not insert metallic objects (chopsticks, coins, hairpins, etc) or objects that burn easily (paper, matches, etc) into the product (via the vent or input/output ports, etc).

- If foreign substances enter the product, be sure to power off the product and disconnect the power cord. Then contact Samsung Customer Service Centre.
- Product failure, an electric shock or fire may result.



Do not place objects containing liquid (vases, pots, bottles, etc) or metallic objects on top of the product.

- If foreign substances such as water enter the product, be sure to disconnect the power cord. Then contact Samsung Customer Service Centre.
- Product failure, an electric shock or fire may result.

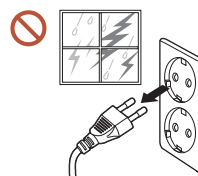

During a lightning or thunderstorm, power off the product and disconnect the power cord.

An electric shock or fire may result.



Do not leave heavy objects or items that children like (toys, sweets, etc.) on top of the product.

The product or heavy objects may fall as children try to reach for the toys or sweets resulting in a serious injury.



Do not hang on or climb on the product.

- The product may fall, causing personal injury or even death.
- Be especially careful that children do not hang on or climb on the product.

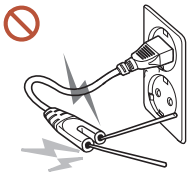

While the power plug is plugged into a power socket, do not insert a chopstick or other conductor into a remaining power socket. Also, after disconnecting the power plug from the power socket, do not touch the pins of the plug immediately.

Otherwise, an electric shock may result.



There is a high voltage inside the product. Never disassemble, repair or modify the product yourself.

- Contact Samsung Customer Service Centre for repairs.
- An electric shock or fire may result.

**!** If a gas leakage is found, do not touch the product or the power plug, and ventilate the room immediately.

Sparks can cause an explosion or fire.

**⊘** Do not use humidifiers or stoves around the product.

An electric shock or fire may result.

**⚠ Caution**

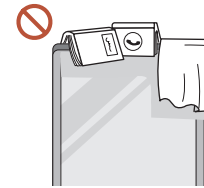

Do not place heavy objects on the product.

Product failure or personal injury may result.

**!** When you do not use the product for a long time due to vacation or other reason, disconnect the power cord from the power socket.

Dust accumulation combined with heat can cause a fire, electric shock or electric leakage.

**!** Use the product at the recommended resolution and frequency.

Your eyesight may deteriorate.

**!** Rest your eyes for more than 5 minutes for every 1 hour of product use.

Eye fatigue will be relieved.

**!** Leaving the screen fixed on a stationary image for an extended period of time may cause afterimage burn-in or defective pixels.

When you do not use the product for a long time, activate power-saving mode or set the screen saver to moving-picture mode.

**!** Do not use or keep combustible spray or an inflammable substance near the product.

An explosion or fire may result.

**⊘** Do not watch the product screen too closely and continuously for a long time.

Your eyesight may deteriorate.

**⊘** Do not lift or move the product when it is in operation.

**⊘** Do not touch the screen when the product has been turned on for an extended period of time as it will become hot.



## Cleaning

### ⚠ Warning



Do not spray water or cleaner directly on the product.

- The product's surface may be damaged, or the markings may be erased.
- An electric shock or fire may result.

### ⚠ Caution

- ! When cleaning, be sure to disconnect the power plug.
- ! Wipe the surface with a slightly wet, soft cloth, and then wipe with a dry cloth.

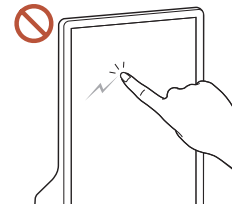
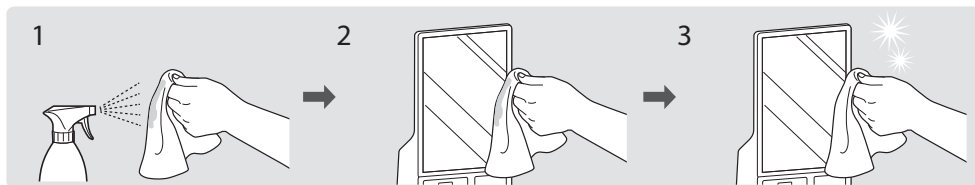

Wipe gently with a soft and dry cloth such as superfine fibers or cotton flannels to prevent scratches because the surface of the product and the screen display are vulnerable to scratches.

- The product's surface may be damaged, or the markings may be erased.
- The product's surface or the screen display can be easily scratched with foreign substances.
- Do not scratch the screen with nails or sharp objects. Scratches may leave marks or damage the product.
- Removing a sticker attached on the screen may leave residues. Clean the residues before watching the screen.
- Do not strongly press and rub the product. Damage to the product may result.

! If you need to clean the glass part of the touchscreen models, apply IPA (Isopropyl Alcohol, 70% or less) on a smooth dry cloth (such as superfine fibers or cotton flannels), and gently wipe with it.

- IPA (Isopropyl Alcohol) is a colourless and flammable drug that can cause eye damage when it gets in the eye, and it is harmful to the human body. Please handle with care.
- If you use IPA (Isopropyl Alcohol) to clean any other part than the glass parts, the product's exterior may be discoloured or cracked, the surface of the panel may be peeled off, or the marking may be erased.

⊘ Do not apply chemicals containing alcohol, solvent, or surfactant such as wax, benzene, thinner, pesticide, air freshener, lubricant, or cleaner to the product. The product's exterior may be discoloured or cracked, the surface of the panel may be peeled off, or the markings may be erased.

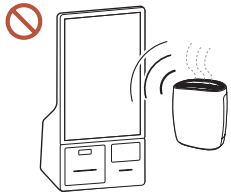

Due to the characteristics of high-glossy products, using a UV humidifier nearby may create white-coloured stains on the product.

 Contact Samsung Customer Service Centre if the inside of the product needs cleaning (service fee will be charged).

## Data precautions

Samsung shall not be liable for any data loss. Please take care to avoid losing any important data and back up your data to prevent any such data loss.

## Operating system and software support

If you change the product's factory OS (Operating System) to another OS or if you install software which is not supported by the product's original factory OS, you will not receive any technical support, product exchange or refund, and a fee will be charged when requesting a service.

Please use your product with the original factory OS. If you install an OS other than the factory OS, data may be deleted or the product may not start.

\* Please use only Windows 10 IOT Enterprise 64-bit for this model.

## Product capacity representation

### Storage capacity representation

The capacity of the storage device (HDD, SSD) of the manufacturer is calculated assuming that 1 KB = 1,000 Bytes.

However, the operating system (Windows) calculates the storage device capacity assuming that 1 KB = 1,024 Bytes. Therefore, the available capacity of the HDD in Windows is smaller than the actual capacity due to the difference in capacity calculation. For example, for an 80 GB HDD, Windows calculates the capacity as 74.5 GB,  $(80 \times 1,000 \times 1,000 \times 1,000) \text{ Bytes} / (1,024 \times 1,024 \times 1,024) \text{ Bytes} = 74.505 \text{ GB}$ .

In addition, the capacity representation in Windows may be even smaller because some programs, such as Samsung Recovery, may reside in a hidden area of the HDD.

### Memory capacity representation

The available memory capacity in Windows is less than the actual capacity of memory. This is because some memory is required for regular system operations.

For example, for 1 GB (= 1,024 MB) memory installed, Windows may report the capacity as 1,022 MB or less.

# Chapter 02

## Preparations

### Checking the components

#### Display

- Contact the vendor where you purchased the product if any components are missing.
- The pictures may look different from the actual components.
- The provided components may differ depending on the model and the country.

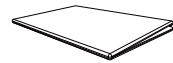

Quick setup guide

---



Warranty card

---



Regulatory guide

---



Power cord

---

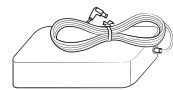

Power adapter

---

## Connection Box

 Below components are included in the Connection Box which needs to be purchased separately.

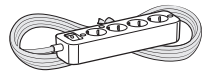

Power strip

---

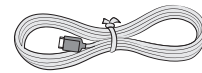

OCM cable

---



Screw(M4, L12) x 7

---



Screw(M3, L5) x 11

---



Sheet cover x 2

---

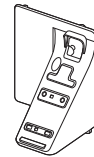

EFT Terminal cover holder

---



Screw(M3, L8) x 2

---











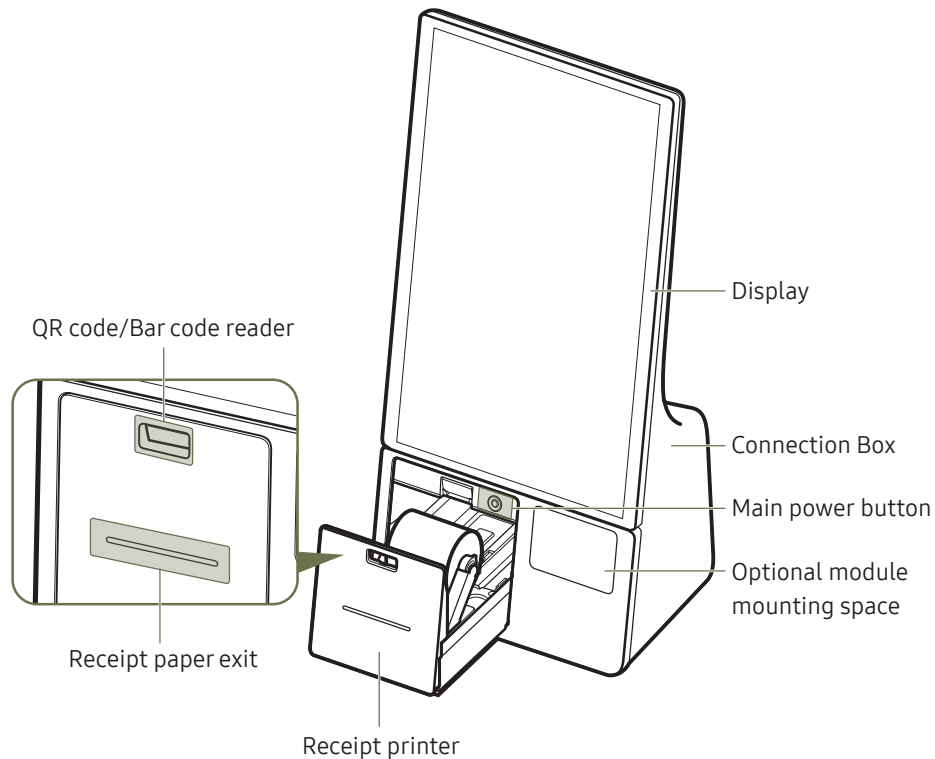

EFT Terminal holder guide

---

## Parts

 The colour and the appearance may differ depending on the product, and specifications are subject to change without prior notice to improve the performance.



Parts	Description
Display	Displays the Kiosk App or the screen of the external device.
Connection Box	Connection Box includes all the payment related equipment.
QR code/bar code reader	<p>A sensor for QR code and bar code recognition.</p> <p> Optimum operation condition</p> <ul style="list-style-type: none"> <li>- Distance from the sensor: 100 ~ 150 mm</li> <li>- Bar code length : 30 ~ 60 mm</li> <li>- QR code size : (25 ~ 30 mm) x (25 ~ 30 mm)</li> </ul> <p> SDK update and user guide</p> <ul style="list-style-type: none"> <li>- To update the SDK, you may download the update file at Samsung digital solution website (<a href="https://displaysolutions.samsung.com">https://displaysolutions.samsung.com</a>).</li> <li>- You can check the user guide at 'C:\Program Files\Samsung\ScanAndDecode\Doc\'. </li> </ul>
Receipt printer	<p>Prints receipt.</p> <p> The printer is displayed as COM4 in Device Manager. For more information on usage and settings, please refer to the Bixolon website at <a href="https://www.bixolon.com">https://www.bixolon.com</a>. (Model: BK3-31)</p>
Main power button	<p>Use this button to turn on or force-shutdown the product.</p> <ul style="list-style-type: none"> <li>• Press the Main power button to turn on the product.</li> <li>• To force-shutdown the product, press and hold the Main power button.</li> </ul> <p> Select the Windows START button (  ) →  → Shutdown to safely turn the product off.</p> <p> Initial booting can take up to 30 seconds because of the boot optimization process.</p> <p> When you turn on the product for the first time, make sure to turn on the display by pressing the jog button on the back of the display.</p>
Optional module mounting space	<p>An extra space for mounting optional payment module.</p> <ul style="list-style-type: none"> <li>• EFT Terminal (Terminal cover holder is provided for this module)</li> </ul> <p> Samsung does not provide or sell any optional modules.</p>

# Display

<Front>

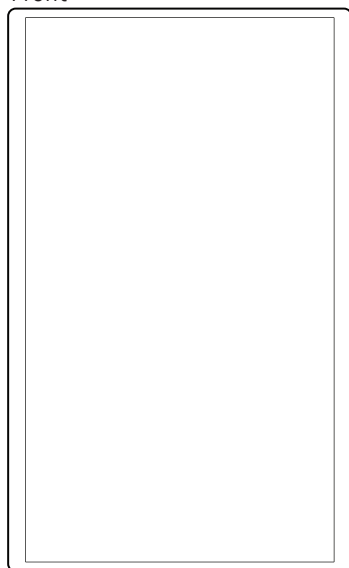

<Back>

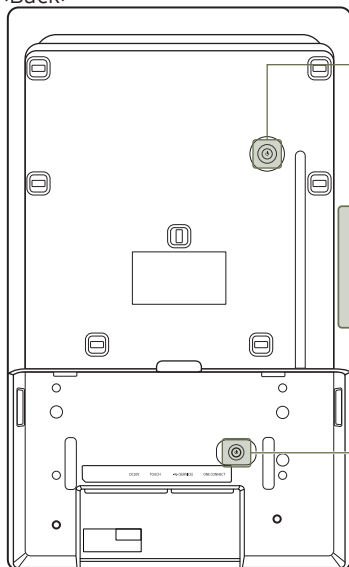

## Function Key Guide

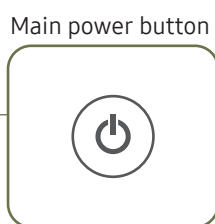
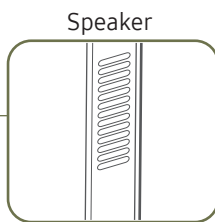
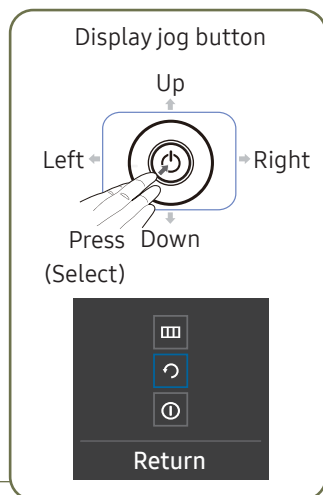



- The colour and the appearance may differ depending on the product, and specifications are subject to change without prior notice to improve the performance.
- This product does not support use of the remote control.



Parts	Description	
Main power button	Use this button to turn on or force-shutdown the product. <ul style="list-style-type: none"> <li>Press the Main power button to turn on the product.</li> <li>To force-shutdown the product, press and hold the Main power button.</li> </ul>	
	Select the Windows START button (Windows logo) → Power button → Shutdown to safely turn the product off.	
	This button can only be accessed if the display has been disassembled from the Connection Box. Therefore, Use the Main power button on the Connection Box while the display is assembled to the Connection Box. (Refer to page 13)	
	Force-shutdown and abnormal shutdown may cause data corruption and Samsung is not liable for such corrupted data.	
	Initial booting can take up to 30 seconds because of the boot optimization process.	
Display jog button	When you turn on the product for the first time, make sure to turn on the display by pressing the jog button on the back of the display.	
	A multi-directional button that helps navigate. <ul style="list-style-type: none"> <li> You must remove the display's back cover to use the display jog button.</li> </ul>	
Function Key Guide		
To use the Function Key Guide, press the jog button when the screen is turned on.		
Menu		Displays the main on-screen menu. <ul style="list-style-type: none"> <li>To enable or disable the menu lock, move to the next step (move the jog button to the right) with the "Menu" displayed, and then push the jog button to the left for 10 seconds until the menu screen disappears.</li> </ul>
Power Off		Turns off the display. <ul style="list-style-type: none"> <li> Only the display turns off and the product remains on. To turn on the display, press the jog button.</li> </ul>
Return		Exits from the menu page.

# Ports

## Display

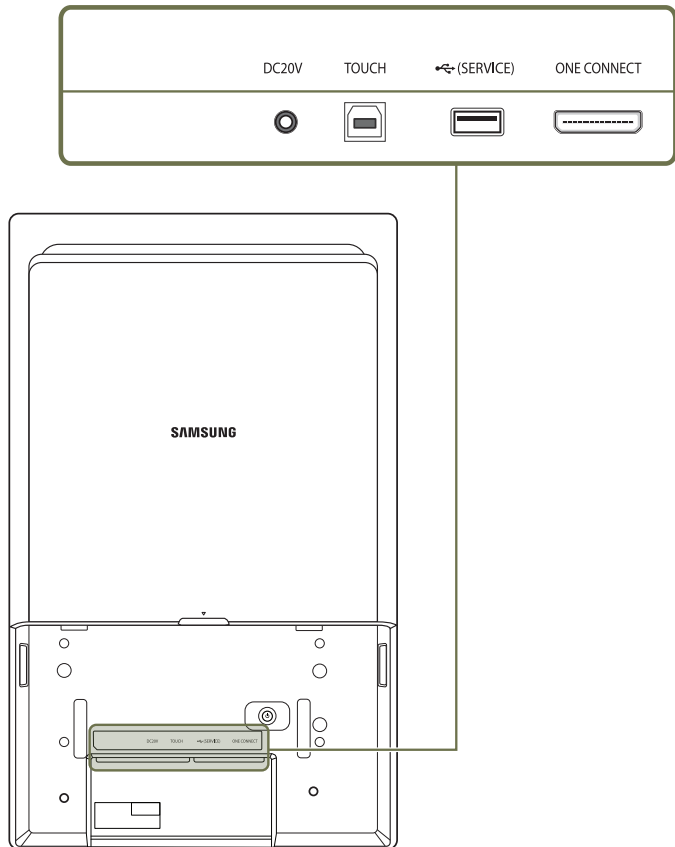
-  The colour and the appearance may differ depending on the product, and specifications are subject to change without prior notice to improve the performance.
-  To access the display ports, you must disassemble the display from the Connection Box.



Ports	Description
DC20V	This port is for connecting the display's power adapter.
TOUCH	This port is not a functioning port.  It is only used for an operation test during the manufacturing process.
 (SERVICE)	Connects to a USB device.  The USB ports on the product accept a maximum constant current of 1.0A. If the maximum value is exceeded, USB ports may not work.
ONE CONNECT	Connects the display and the Connection Box using an OCM cable.

## Before Installing the Product (Installation Guide)

This product can be installed and used with the exclusive Samsung stand sold separately by Samsung Electronics, and also can be wall-mounted.

 Do not use this model installed on a ceiling, floor, or table.

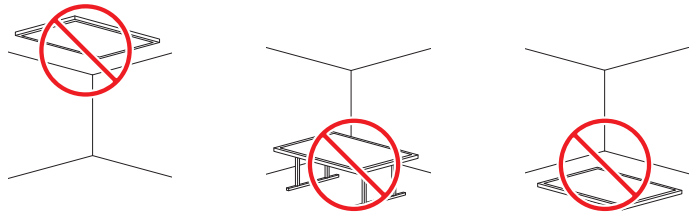

### Ventilation

Do not block the ventilation openings at the top of the back of the display.

Blocking the ventilation openings may cause overheating and lead to product malfunction.

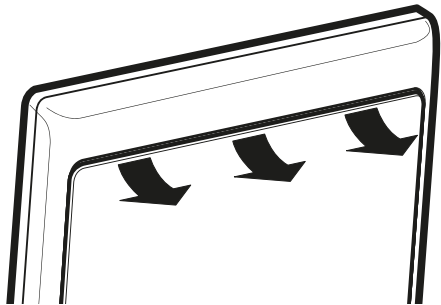

Contact Samsung Customer Service Centre for further details.

### Installation on a Perpendicular Wall

A A Minimum 15 mm

B B Ambient temperature: 35 °C or less

 When installing the product on a perpendicular wall, allow at least 15 mm of space between the product and wall surface for ventilation and ensure that the ambient temperature is kept below 35 °C.

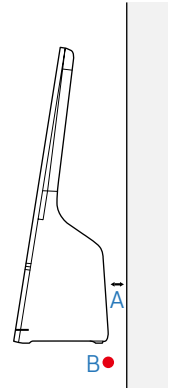

### Installation on an Indented Wall

A A Minimum 15 mm

B B Minimum 25 mm

C C Minimum 25 mm

D D Minimum 0 mm

E E Ambient temperature: 35 °C or less

 When installing the product on an indented wall, allow minimum space between the product and walls as indicated in the figure for ventilation, and ensure that the ambient temperature is kept below 35 °C.

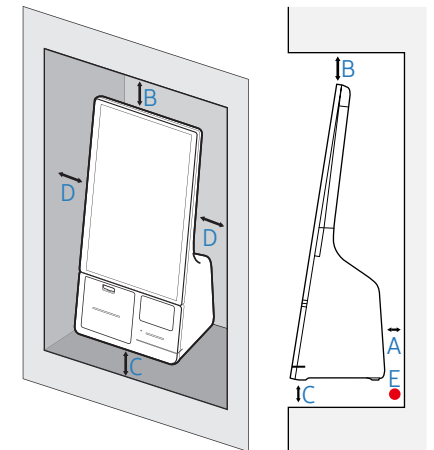



# Installing the Wall Mount

## Installing the Wall Mount

- The wall mount kit (sold separately) allows you to mount the product on the wall.
- The provided image is only for reference. For detailed information on installing the wall mount, see instructions provided with the wall mount.
- We recommend you contact a technician for assistance when installing the wall mount bracket.
- Samsung is not responsible for any damage or injury caused to the product, you or other people by installing the product without expert help.

## Wall Mount Kit Specifications (VESA)

Install your wall mount on a solid wall perpendicular to the floor.

 To install the product on the unauthorized wall mount kit, contact the nearest agency. If you install the product on a slanted wall, it may fall and result in severe personal injury.

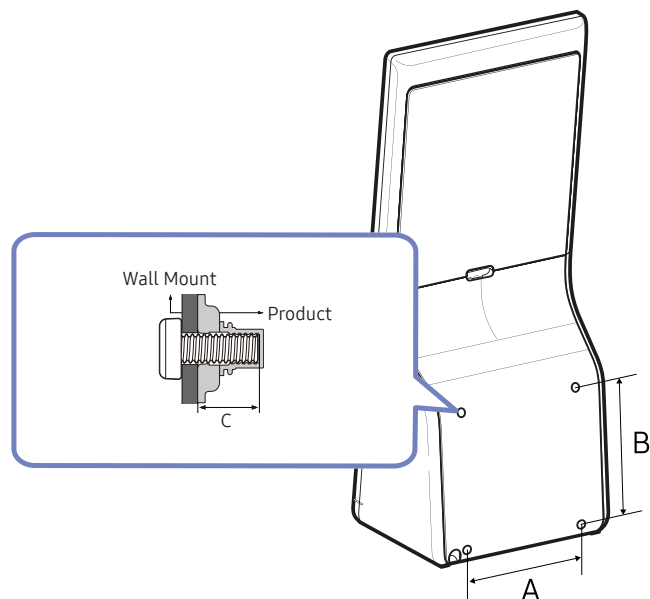

- Do not use screws that are longer than the standard length or do not comply with the VESA standard screw specifications. Screws that are too long may cause damage to the inside of the product.
- For wall mounts that do not comply with the VESA standard screw specifications, the length of the screws may differ depending on the wall mount specifications.
- Do not fasten the screws too firmly. This may damage the product or cause the product to fall, leading to personal injury. Samsung is not liable for these kinds of accidents.
- Samsung is not liable for product damage or personal injury when a non-VESA or non-specified wall mount is used or the consumer fails to follow the product installation instructions.
- Do not mount the product at more than a 15 degree tilt.
- Always have at least two people mount the product on a wall.
- Standard dimensions for wall mount kits are shown in the table below.

Model name	VESA standard (A * B) (mm)	C (mm)	Standard Screw	Quantity
KMC-W (KM24C-3, KM24C-C, KM24C-5)	200 x 200	7.0 (Min) ~ 9.0 (Max)	M6	4

 Do not install your Wall Mount Kit while your product is turned on. It may result in personal injury due to electric shock.

# Chapter 03

## Basics

### Touchscreen

Use your fingers on the touchscreen to perform actions.

#### Precautions when using the touchscreen

- Do not subject the touchscreen to severe impacts or press it with sharp objects. Doing so may damage the touchscreen.
- Do not allow the touchscreen to come into contact with other electrical devices. Electrostatic discharges can cause the touchscreen to malfunction.
- Do not expose the touchscreen to water. The touchscreen may malfunction in humid conditions or when exposed to water.
- Do not spray liquid cleansing solutions directly onto the touchscreen. The solution may enter the touchscreen or cause undesired operation. To clean the screen, dampen a cloth with the solution and gently wipe the screen. Do not use solutions or cloths that contain abrasive materials, as they may damage the touchscreen.
- Do not damage the edges of the touchscreen. Doing so may damage the touchscreen.
- Leaving the touchscreen idle for extended periods may result in afterimages (screen burn-in) or ghosting. Turn off the touchscreen when you are not using the product.
- Make sure your hands are clean and dry before using the touchscreen. Remove any moisture from your hands before using the touchscreen.
- Do not expose the product to foreign substances. Doing so may cause the touchscreen to malfunction.

#### Tips on using the touchscreen

- Very light touches on the touchscreen may not be recognized.
- Precisely tap items on the touchscreen for the best results.
- When used under some 3-wavelength lamps, the touchscreen could malfunction.
- The touchscreen sensors are located on the edges of the touchscreen. Therefore, do not cover the edges of the touchscreen with protective covers or accessories.
- Touchscreen gestures are available for touchscreen models running Windows and work only with some applications.

---

## Touch screen gestures

### Tap



To select menus, options, or applications, tap the touch screen.

 It is similar to clicking on a mouse.

### Double-tap



To open files or items, double-tap the touch screen.

 It is similar to double-clicking on a mouse.

### Touch and hold (right-click)



To use additional options of an item, touch and hold it on the touch screen.

### Drag

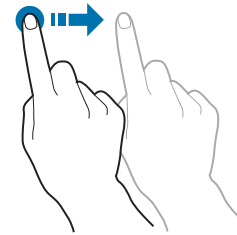

To move an item to another location, touch and hold it, and then drag it on the touch screen to the desired location.

 It is similar to dragging a mouse.

## Scrolling

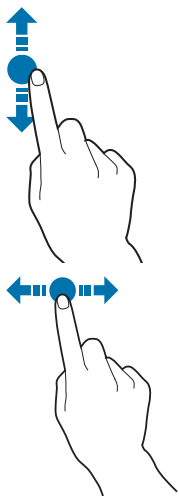

To scroll up, down, left, or right, swipe on the touch screen.

## Entering text

Use the on-screen keyboard to enter text.

To open the on-screen keyboard, select  on the taskbar.









 Some languages are not supported by the virtual keyboard. To enter text, change the input language to one of the supported languages.

 The on-screen keyboard is only available in tablet mode.

To change to tablet mode, select  → **Tablet mode** in the taskbar.

## Changing the keyboard layout

To change the keyboard layout, select  and select one of the following:

	<ul style="list-style-type: none"><li>• Simplified QWERTY keyboard</li></ul>
	<ul style="list-style-type: none"><li>• Mini keyboard<ul style="list-style-type: none"><li>- Mini keyboard is only available in the floating state.</li></ul></li></ul>
	<ul style="list-style-type: none"><li>• Split QWERTY keyboard for entering text with two hands</li></ul>
	<ul style="list-style-type: none"><li>• Standard QWERTY keyboard</li></ul>
	<ul style="list-style-type: none"><li>• Fixed keyboard</li></ul>
	<ul style="list-style-type: none"><li>• Floating keyboard</li></ul>

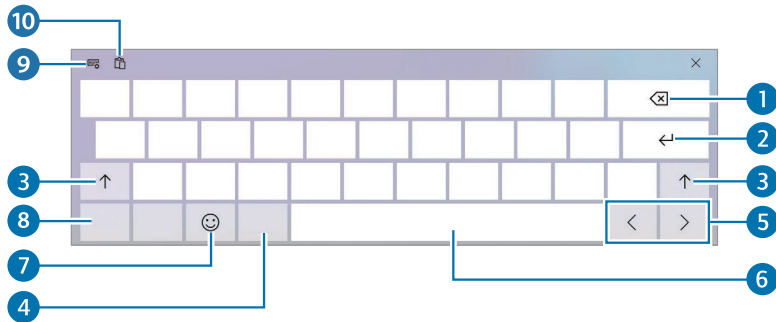



Number	Description
1	<ul style="list-style-type: none"> <li>Delete a preceding character.</li> </ul>
2	<ul style="list-style-type: none"> <li>Move to the next line.</li> </ul>
3	<ul style="list-style-type: none"> <li>Create an uppercase character. For all caps, tap it twice.</li> </ul>
4	<ul style="list-style-type: none"> <li>Change the keyboard language.</li> </ul>
5	<ul style="list-style-type: none"> <li>Move the cursor.</li> </ul>
6	<ul style="list-style-type: none"> <li>Enter a space.</li> </ul>
7	<ul style="list-style-type: none"> <li>Enter emoticons.</li> </ul>
8	<ul style="list-style-type: none"> <li>Enter numerals and punctuation marks.</li> </ul>
9	<ul style="list-style-type: none"> <li>Change the keyboard layout.</li> </ul>
10	<ul style="list-style-type: none"> <li>Add an item from the clipboard.</li> </ul>

## Entering uppercase

Select ↑ before entering a character. For all caps, tap it twice.

## Changing language keyboards

Add keyboards to enter text in other languages. Select  → , select **Add a language** under **Preferred languages**, and then select a language. You can change the input language by selecting the input language key on the on-screen keyboard.

## Copying and pasting

- 1 Drag your finger across text to select it.
- 2 Touch and hold the text to display the options.
- 3 Select **Copy** or **Cut**.
- 4 Touch and hold a text input field and then select **Paste**.

# Window

Microsoft Windows is an operating system that is used to control this product.

- ✎ Images and available features may differ depending on the model and operating system.
- ✎ This manual is designed for Windows 10 and content may differ depending on the OS version.
- ✎ The image displayed on the desktop screen may differ between models and OS versions.

## About Windows Activation

When you turn the product on for the first time, the Windows activation screen appears. Follow the activation procedures according to the instructions on the screen to use the product.

The product's date and time may be incorrect when you turn it on for the first time. They may also be incorrect if the battery has been fully discharged or removed. To set the date and time, go to the desktop taskbar and touch and hold the date and clock area.

Then, select **Adjust date/time** and set the current date and time.

## Configuring the Windows Settings

You can configure the basic system settings, such as installing or uninstalling apps and managing accounts, on the Windows Settings screen.

Select the Windows START button (  ) →  .

Then, select an option you want to change after the Windows Settings screen appears.

- ✎ You can also configure the settings from the Control Panel like previous OS versions.
- ✎ Select the Windows START button (  ) → Windows System → Control Panel.



## Action Center

The Windows 10 action centre allows you to receive system notifications, such as updates, and push notifications, such as emails and social media updates. You can also adjust settings conveniently. For example, you can select wireless network options or adjust the volume through quick actions in the action centre.

### Checking notifications

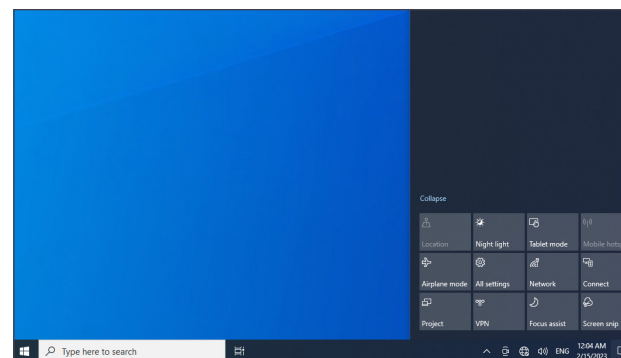
- 1 Select  on the taskbar.
- 2 When the action center panel appears, select a message to check it.



- ✎ You can enable or disable push notifications for applications. You can also set personalized quick actions to appear in the action centre by selecting the Windows START button (  ) →  → System → Notifications & actions.
- ✎ Select Expand or Collapse (  ) to expand or minimize the action centre menu and select the feature you want to use.

## Unlocking the screen

To unlock the lock screen, tap the screen and swipe upwards from the bottom of the screen.

- If the account has a password, enter the password to log in after unlocking the screen.

## Settings & Upgrade

### Volume

Adjust the system volume or sound volume when playing music or video.

#### Controlling volume using the taskbar





- 1 Select  on the taskbar.
- 2 Drag the adjustment bar to the desired volume.



Volume adjustment bar

## BIOS (Setup utility)

Define a boot password, change the boot priority, or configure the installed chipsets.

-  You need to connect a keyboard and a mouse to enter the BIOS screen.
-  Incorrect settings may cause the system to malfunction or crash.
-  The BIOS setup screens, menus, and items may appear differently depending on the model and BIOS version.
-  BIOS setup functions are subject to upgrades.

### Entering the BIOS

- 1 Turn on the product.
- 2 Before the Samsung logo appears, press the F2 key several times.
  - If the product is password-protected, press the F2 key several times before the password screen appears.
  - If the password screen or the Windows start screen appears, restart the product and try again.

## The BIOS screen

The BIOS setup screen appears as shown below.

You can change BIOS settings using the keyboard or mouse.

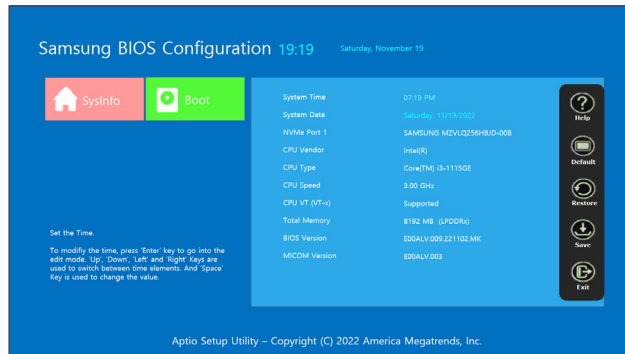

## Boot priority

Change the boot priority from the BIOS setup.

- 1 Turn on the product.
- 2 Before the Samsung logo appears, press the F2 key several times.
- 3 Access the **Boot** menu.
- 4 Select **Boot Device Priority**.
- 5 Select an option menu to open the list.
- 6 Select an option.
- 7 Select **Save** → **OK** to save and restart.
- 8 Select **Exit** → **OK** to restart without saving the changes.

Number	Name
1	<ul style="list-style-type: none"><li>• Setup items</li></ul>
2	<ul style="list-style-type: none"><li>• Setup tools<ul style="list-style-type: none"><li>- <b>Help</b>: View the help for BIOS setup.</li><li>- <b>Default</b>: Return to the default settings.</li><li>- <b>Restore</b>: Cancel changes.</li><li>- <b>Save</b>: Save settings.</li><li>- <b>Exit</b>: Exit BIOS setup.</li></ul></li></ul>
3	<ul style="list-style-type: none"><li>• Setup menu<ul style="list-style-type: none"><li>- <b>SysInfo</b>: View the basic specifications of the product.</li><li>- <b>Boot</b>: Configure peripherals and boot-related settings.</li></ul></li></ul>

 The BIOS setup screen appears only in English.



# Chapter 04

## Menu

Function Key Guide → 

### Picture







2nd	3rd	Description
<b>Picture Mode</b>		Set to an optimum picture quality suitable for the working environment. <ul style="list-style-type: none"><li>• <b>Custom</b>: Customize the contrast and brightness as required.</li><li>• <b>Standard</b>: Sets the picture quality suitable for standard use.</li></ul>
<b>Brightness</b>		Adjust the brightness level. Values closer to 100 mean a brighter screen.
<b>Contrast</b>		Adjust the contrast level. Values closer to 100 mean a bigger light/dark contrast.
<b>Sharpness</b>		Adjust the sharpness of the picture. Values closer to 100 mean a sharper image.
<b>Picture Enhancer</b>		Displays enhanced colour and sharpness.
<b>Colour</b>		Configure colour settings.
	<b>Colour Tone</b>	Select a colour tone that best suits your viewing needs. <ul style="list-style-type: none"><li>• If you select <b>Custom</b>, the user can set the desired value of the Red, Green, and Blue. The preset values of Red, Green, and Blue are applied If you select anything other than <b>Custom</b>.</li></ul>
	<b>Red</b>	Adjust the red saturation level. Values closer to 100 mean greater intensity for the colour.
	<b>Green</b>	Adjust the green saturation level. Values closer to 100 mean greater intensity for the colour.
	<b>Blue</b>	Adjust the blue saturation level. Values closer to 100 mean greater intensity for the colour.
	<b>Gamma</b>	Adjust the middle level of luminance.
<b>Black Level</b>		Optimize HDMI picture brightness and contrast by adjusting the black level of the video signal.
<b>Response Time</b>		Accelerate the panel response rate to make video appear more vivid and natural.
<b>Screen Ratio</b>		Choose the size and aspect ratio of the picture displayed on screen.
<b>Dynamic Brightness</b>		Automatically adjust the Brightness to provide the best possible screen contrast under the current conditions.

---

## Onscreen Display

2nd	3rd	Description
Transparency		Configure the transparency of the menu windows.
Language		Set the menu language. <ul style="list-style-type: none"><li>Selected language only applies to the menu.</li></ul>
Display Time		Set how long the menu window will remain on screen for when it is not in use.

# Support

2nd	3rd	Description
Self Diagnosis		<p>Perform this test when you experience a problem with your monitor's picture.</p> <ul style="list-style-type: none"><li>Do not turn off the product when Self Diagnosis is in progress. Try to avoid any interruptions during the Self Diagnosis process.</li></ul>
Software Update		<p>Update software using an update file on a USB device. The USB device should be connected to the USB port labelled SERVICE.</p> <ol style="list-style-type: none"><li>Save the update file (in .bin format) that you downloaded from the Samsung website (<a href="http://www.samsung.com/sec">http://www.samsung.com/sec</a>) to a USB device.</li><li>Connect the USB device to the  (SERVICE) port. Select  → <b>Support</b> → <b>Software Update</b>.</li><li>Follow the instructions on the screen to proceed with the update.</li><li>Your product will turn itself off and on again automatically after completing update and then turn off your product.<ul style="list-style-type: none"><li>Remove the power cord from the power outlet and then reconnect the cord after turning it off.</li><li>To perform software updates by using a USB device, first format the USB device to FAT32.</li><li>When updating by a USB device, be sure to use the device whose version of USB 3.0 or lower.</li><li>When performing the update, make sure that only one BIN file (.bin) is saved in the root directory.</li><li>If the '<b>No update files found on your USB device. Please check your USB device and try again.</b>' message is displayed, this is probably due to the following reasons.<ul style="list-style-type: none"><li> A USB device is not connected to the  (SERVICE) port.</li><li> The files in the connected USB device are not compatible formats.</li><li> There are no valid update files found in the connected USB device. (There are no update files saved in the memory or the file names are incorrect.)</li></ul></li><li>The update will not start if the downloaded software does not match the software installed on the monitor. To check the software for consistency, select  → <b>Support</b> → <b>Information</b>.</li><li>Do not turn off the product until the update is complete. And prevent the updating from any interruption as far as possible. In general, the product returns to the previous version if an update is interrupted.</li></ul></li></ol>
Information		View product information like model name.
Reset All		Return all the settings for the product to the default factory settings.

# Chapter 05

## Troubleshooting Guide



### Requirements Before Contacting Samsung Customer Service Centre

Follow the instruction on the right to test your product before requesting for service. If the problem persists, contact Samsung Customer Service Centre.

The power indicator may not be supported depending on the model.

#### Check the followings.

Screen issues	
The screen does not display anything.	Make sure that the power cord is connected.
	Press the Main power button and check if the product has turned on.
<b>No Signal</b> message appears on the screen and then disappears.	Check that products (including source device) are connected correctly with a cable.
	Check that the source device connected to the product is powered on.
The screen is too bright. The screen is too dark.	Go to <b>Picture</b> and adjust the <b>Brightness</b> and <b>Contrast</b> settings.
The screen display does not look normal.	A cell phone within a distance of one-meter radius may cause static on analog and digital products.
The brightness and colour do not look normal.	Go to <b>Picture</b> and adjust the screen settings such as <b>Colour</b> , <b>Brightness</b> and <b>Sharpness</b> .
	Reset the screen settings to the default settings. (page 27)
I see red, green, and blue.	This issue may happen when the panel of the product is defective. Contact a Samsung Service Centre to resolve the issue.
The screen cannot be displayed in full screen.	A scaled SD (4:3) content file can cause black bars on both sides of an HD channel screen.
	A video with an aspect ratio different from the product can cause black bars at the top and bottom of the screen.

Screen issues	
The screen is landscape oriented.	<p>In Windows display settings, change the display orientation to "Portrait". You can access the display settings in following ways:</p> <ul style="list-style-type: none"> <li>• Touch and hold the desktop, and then tap <b>Display Settings</b>.</li> <li>• Select the Windows <b>START</b> button (  ) →  → <b>System</b> → <b>Display</b>.</li> </ul>
Sound issue (For models with built-in speakers)	
There is no sound.	Check the volume.
The volume is too low.	<p>Adjust the volume.</p> <p>If the volume is still low after turning it up to the maximum level, adjust the volume on the Windows or software program.</p>
Touch function issues	
Touches break, reaction speed gets slow, and so on.	Make sure that there are no foreign substances on the screen surface.
	Check whether the screen is broken.
	Place the product at least 3 m away from any devices that use high voltage.
Other issue	
The product smells like plastic.	The plastic smell is normal and disappears over time.
The monitor appears tilted.	Remove and then attach the stand again to the product.
Small particles are found on the edges of the product.	The particles are part of the product design. The product is not defective.

**Payment module issue**

Printer is not working.

Make sure there is enough receipt paper in the printer.

Make sure the receipt paper is properly inserted into the printer.

Make sure the cover of the receipt paper is closed.

Check the power and signal cable connection status, and restart the product.

Press the Self Test button to check if the printer works. It is not the problem of the printer if it works.

QR code/bar code sensor

Check the power and signal cable connection status, and restart the product.

If the recognition results are poor, clean the sensor with a smooth, damp cloth, and then wipe out the moisture and try again.

The printer is not working.  
COM port operation is abnormal.

Check the Baud-rate settings and the port numbers of the device and your product.

Check the USB Driver on the **Device Manager** menu.

- Check if **USB-Serial Adapter** exists under the **Device Manager – Universal Serial Bus controllers** menu.
- If **USB-Serial Adapter** exists, follow the below instructions to update the driver.

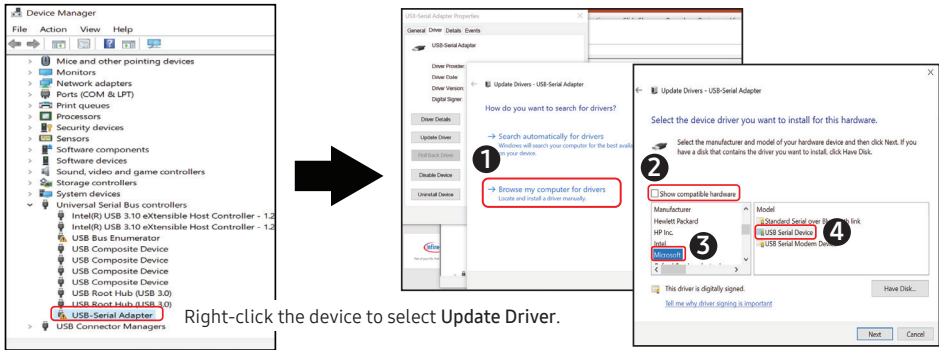

**Windows issues**

How can I uninstall an application?

- 1 Select the Windows START button (Windows logo) → Settings (gear icon) → Apps → Apps & features.
- 2 On the list, select an app to delete, and then select Uninstall.

---

## Windows recovery function

If the Samsung Recovery application is not supported by the product, reinstall Windows using the recovery function of Windows.



Reinstalling Windows will erase all data saved on the product.

Back up applications and personal data to an external storage device before reinstalling Windows.

- 1 Select the Windows START button () →  → Update & Security → Recovery.
  - 2 Select **Reset this PC** → **Get started**.
  - 3 Select **Keep my files** or **Remove everything**.
-  After the system is recovered, select the Windows START button () → **Samsung Update** to install the required Samsung applications.



# Chapter 06

## Specifications

### General

Model Name		KMC-W (KM24C-3, KM24C-C, KM24C-5)
Panel	Size	24 CLASS (23.8 inches / 60.4 cm)
	Display area	527.04 mm (H) x 296.46 mm (V)
Resolution	Optimum resolution	1920 × 1080 @ 60 Hz
	Maximum resolution	
Power Supply		AC100-240V~ 50/60Hz Refer to the label at the back of the product as the standard voltage can vary in different countries.
Environmental considerations	Operating	Temperature: 0 °C ~ 40 °C (32 °F ~ 104 °F) * For installing the enclosure, keep the internal temperature at 35 °C or below. Humidity: 10 % ~ 80 %, non-condensing
	Storage	Temperature: -20 °C ~ 45 °C (-4 °F ~ 113 °F) Humidity: 10 % ~ 90 %, non-condensing * Applicable before the product package is unpacked.
Receipt printer	Type	3 inch thermal printing
	Power	Exclusive adapter
	Signal	Serial / USB

Model Name		KMC-W (KM24C-3, KM24C-C, KM24C-5)
QR code/bar code sensor	Resolution	640 * 480
	Power and signal	USB (Format : UVC 1.1)
	Others	Red Aimer / White LED

-  Due to the nature of the manufacturing of this product, approximately 1 pixel per million (1ppm) may appear brighter or darker on the panel. This does not affect product performance.
-  This product can be set to only one resolution for each screen size to obtain the optimum picture quality due to the nature of the panel. Using a resolution other than the specified resolution may degrade the picture quality. To avoid this, it is recommended that you select the optimum resolution specified for your product.
-  For detailed device specifications, visit the Samsung website.



# Chapter 07

## Appendix

### Responsibility for the Pay Service (Cost to Customers)

 When the service is requested, in spite of in warranty, we may charge you for a visit from a service technician in the following cases.

#### Not a product defect

Cleaning of the product, Adjustment, Explanation, Re-installation and etc.

- If a service technician is requested to give instructions on how to use product or simply adjusts options without disassembling product.
- If a defect is caused by external environmental factors (Internet, Antenna, Wired Signal, etc.)
- If a product is reinstalled or devices are connected additionally after installing the purchased product for the first time.
- If a product is reinstalled to move to a different spot or to move to a different house.
- If the customer requests instructions on how to use another company's product.
- If customer requests instructions on how to use the network or another company's program.
- If customer requests software installation and setup for the product.
- If a service technician removes/cleans dusts or foreign materials inside of the product.
- If customer requests an installation additionally after purchasing a product through home-shopping or online.

### A Product damage caused by customer's fault

Product damage caused by customer's mishandling or wrong repair.

If a product damage is caused by;

- External impact or drop.
- Use of supplies or separately sold product unspecified by Samsung.
- Repair from a person besides an engineer of outsourcing service company or partner of Samsung Electronics Co.,LTD.
- Remodeling or repairing the product by customer.
- Using it with incorrect voltage or non-authorized electrical connections.
- Not following the "cautions" in User Manual.

#### Others

- If product fails by natural disaster. (lightning, fire, earthquake, flood damage, etc)
  - If consumable components are all used up. (Battery, Toner, Fluorescent lights, Head, Vibrator, Lamp, Filter, Ribbon, etc.)
-  If customer requests a service in case the product has no defect, service fee may be charged. So please read User Manual first.

## Prevention of Afterimage Burn-in

### What is afterimage burn-in?

Afterimage burn-in should not occur when the panel is operating normally. Normal operation refers to a continuously changing video pattern. If the panel displays a fixed pattern for an extended period of time a slight voltage difference may occur between the electrodes in pixels that control the liquid crystals.

Such a voltage difference between electrodes increases with time and makes the liquid crystals thinner.

When this occurs, a previous image can remain on the screen when the pattern changes.

- ⊘ This information is a guide to prevent afterimage burn-in. Viewing a fixed screen for an extended period of time may cause afterimage burn-in. This problem is not included in warranty.

### Recommended prevention practices

Viewing a fixed screen for an extended period of time may cause afterimage burn-ins or smudges. If the product is not to be used for a long time, turn it off, or activate the Power Saving mode or Screen Saver with a moving image.

- Change the colours regularly.



- Avoid combinations of a text colour and background colour of contrasting brightness.
- ✎ Avoid using colours of contrasting brightness (black and white; gray and black).



---

# License

---

Open Source License Notice

Open Source used in this product can be found on the following webpage (<https://opensource.samsung.com>).

---