

**ASUS®**

**VP349CGL Series  
LCD Monitor**

**User Guide**

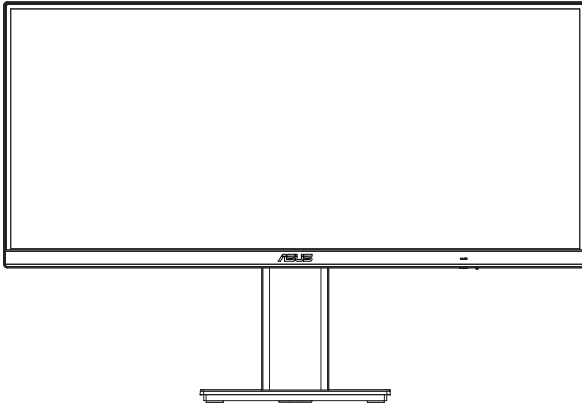

**HDMI™**  
HIGH-DEFINITION MULTIMEDIA INTERFACE

# Table of contents

Notices .....	iii
Safety information .....	iv
Care & Cleaning .....	vii
1.1 Welcome .....	1-2
1.2 Package contents.....	1-2
1.3 Assembling the monitor.....	1-3
1.4 Connect cables.....	1-4
1.4.1 Rear of the LCD monitor.....	1-4
1.5 Monitor introduction .....	1-5
1.5.1 Using the Controls button .....	1-5
2.1 Detaching the arm/stand (for VESA wall mount) .....	2-1
2.2 Adjusting the monitor .....	2-2
2.3 Outline dimension.....	2-3
3.1 OSD (On-Screen Display) menu .....	3-1
3.1.1 How to reconfigure.....	3-1
3.1.2 OSD Function Introduction.....	3-2
3.2 Specifications.....	3-14
3.3 Troubleshooting (FAQ).....	3-15
3.4 Supported Timing List.....	3-16

Copyright © 2021 ASUSTeK COMPUTER INC. All Rights Reserved.

No part of this manual, including the products and software described in it, may be reproduced, transmitted, transcribed, stored in a retrieval system, or translated into any language in any form or by any means, except documentation kept by the purchaser for backup purposes, without the express written permission of ASUSTeK COMPUTER INC. ("ASUS").

Product warranty or service will not be extended if: (1) the product is repaired, modified or altered, unless such repair, modification or alteration is authorized in writing by ASUS; or (2) the serial number of the product is defaced or missing.

ASUS PROVIDES THIS MANUAL "AS IS" WITHOUT WARRANTY OF ANY KIND, EITHER EXPRESS OR IMPLIED, INCLUDING BUT NOT LIMITED TO THE IMPLIED WARRANTIES OR CONDITIONS OF MERCHANTABILITY OR FITNESS FOR A PARTICULAR PURPOSE. IN NO EVENT SHALL ASUS, ITS DIRECTORS, OFFICERS, EMPLOYEES OR AGENTS BE LIABLE FOR ANY INDIRECT, SPECIAL, INCIDENTAL, OR CONSEQUENTIAL DAMAGES (INCLUDING DAMAGES FOR LOSS OF PROFITS, LOSS OF BUSINESS, LOSS OF USE OR DATA, INTERRUPTION OF BUSINESS AND THE LIKE), EVEN IF ASUS HAS BEEN ADVISED OF THE POSSIBILITY OF SUCH DAMAGES ARISING FROM ANY DEFECT OR ERROR IN THIS MANUAL OR PRODUCT.

SPECIFICATIONS AND INFORMATION CONTAINED IN THIS MANUAL ARE FURNISHED FOR INFORMATIONAL USE ONLY, AND ARE SUBJECT TO CHANGE AT ANY TIME WITHOUT NOTICE, AND SHOULD NOT BE CONSTRUED AS A COMMITMENT BY ASUS. ASUS ASSUMES NO RESPONSIBILITY OR LIABILITY FOR ANY ERRORS OR INACCURACIES THAT MAY APPEAR IN THIS MANUAL, INCLUDING THE PRODUCTS AND SOFTWARE DESCRIBED IN IT.

Products and corporate names appearing in this manual may or may not be registered trademarks or copyrights of their respective companies, and are used only for identification or explanation and to the owners' benefit, without intent to infringe.

# Notices

## Federal Communications Commission Statement

This device complies with Part 15 of the FCC Rules. Operation is subject to the following two conditions:

- This device may not cause harmful interference.
- This device must accept any interference received including interference that may cause undesired operation.

This equipment has been tested and found to comply with the limits for a Class B digital device, pursuant to Part 15 of the FCC Rules. These limits are designed to provide reasonable protection against harmful interference in a residential installation. This equipment generates, uses and can radiate radio frequency energy and, if not installed and used in accordance with the instructions, may cause harmful interference to radio communications. However, there is no guarantee that interference will not occur in a particular installation. If this equipment does cause harmful interference to radio or television reception, which can be determined by turning the equipment off and on, the user is encouraged to try to correct the interference by one or more of the following measures:

- Reorient or relocate the receiving antenna.
- Increase the separation between the equipment and receiver.
- Connect the equipment to an outlet on a circuit different from that to which the receiver is connected.
- Consult the dealer or an experienced radio/TV technician for help.



## Canadian Department of Communications Statement

This digital apparatus does not exceed the Class B limits for radio noise emissions from digital apparatus set out in the Radio Interference Regulations of the Canadian Department of Communications.

This class B digital apparatus complies with Canadian ICES-003.

Made in China

## Safety information

- Before setting up the monitor, carefully read all the documentation that came with the package.
- To prevent fire or shock hazard, never expose the monitor to rain or moisture.
- Never try to open the monitor cabinet. The dangerous high voltages inside the monitor may result in serious physical injury.
- If the power supply is broken, do not try to fix it by yourself. Contact a qualified service technician or your retailer.
- Before using the product, make sure all cables are correctly connected and the power cables are not damaged. If you detect any damage, contact your dealer immediately.
- Slots and openings on the back or top of the cabinet are provided for ventilation. Do not block these slots. Never place this product near or over a radiator or heat source unless proper ventilation is provided.
- The monitor should be operated only from the type of power source indicated on the label. If you are not sure of the type of power supply to your home, consult your dealer or local power company.
- Use the appropriate power plug which complies with your local power standard.
- Do not overload power strips and extension cords. Overloading can result in fire or electric shock.
- Avoid dust, humidity, and temperature extremes. Do not place the monitor in any area where it may become wet. Place the monitor on a stable surface.
- Unplug the unit during a lightning storm or if it will not be used for a long period of time. This will protect the monitor from damage due to power surges.
- Never push objects or spill liquid of any kind into the slots on the monitor cabinet.
- To ensure satisfactory operation, use the monitor only with UL listed computers which have appropriate configured receptacles marked between 100 ~ 240V AC.
- The socket-outlet shall be installed near the equipment and shall be easily accessible
- If you encounter technical problems with the monitor, contact a qualified service technician.
- Provide an earthing connection before the mains plug is connected to the mains. And, when disconnecting the earthing connection, be sure to disconnect after pulling out the mains plug from the mains.

## **WARNING**

Usage of other than specified head- or earphones can result in hearing loss due to excessive sound pressures.

**Declaration of Conformity** This device complies with the requirements set out in the Council Directive on the Approximation of the Laws of the Member States relating to Electromagnetic Compatibility (2014/30/EU), Low-voltage Directive (2014/35/EU), ErP Directive (2009/125/EC) and RoHS directive (2011/65/EU). This product has been tested and found to comply with the harmonized standards for Information Technology Equipment, these harmonized standards published under Directives of Official Journal of the European Union.

Excessive sound pressure from earphones and headphones can cause hearing loss. Adjustment of the equalizer to maximum increases the earphones and headphones output voltage and therefore the sound pressure level.

Do not dispose of electrical appliances as unsorted municipal waste, use separate collection facilities.

Contact your local government for information regarding the collection systems available.

If electrical appliances are disposed of in landfills or dumps, hazardous substances can leak into the groundwater and get into the food chain, damaging your health and well-being.

When replacing old appliances with new once, the retailer is legally obligated to take back your old appliance for disposal at least for free of charge.

Please confirm the distribution system in building installation shall provide the circuit breaker rated 120/240V, 20A (maximum).

If provided with a 3-pin attachment plug on the power cord, plug the cord into a grounded (earthed) 3-pin outlet. Do not disable the power cord grounding pin, for example, by attaching a 2-pin adapter. The grounding pin is an important safety feature.

The product may fall, causing serious personal injury or death. To prevent injury, this product must be securely attached to the floor/wall in accordance with the installation instructions.

A product may fall, causing serious personal injury or death. Many injuries, particularly to children, can be avoided by taking simple precautions such as:

**ALWAYS** use cabinets or stands or installation methods recommended by the manufacturer of the product set.

**ALWAYS** use furniture that can safely support the product.

**ALWAYS** ensure the product is not overhanging the edge of the supporting furniture.

**ALWAYS** educate children about the dangers of climbing on furniture to reach the product or its controls.

**ALWAYS** route cords and cables connected to your product so they cannot be tripped over, pulled or grabbed.

**NEVER** place a product in an unstable location.

**NEVER** place the product on tall furniture (for example, cupboards or bookcases) without anchoring both the furniture and the product to a suitable support.

**NEVER** place the product on cloth or other materials that may be located between the product and supporting furniture.

**NEVER** place items that might tempt children to climb, such as toys and remote controls, on the top of the product or furniture on which the product is placed.

If the existing product is going to be retained and relocated, the same considerations as above should be applied.

## Care & Cleaning

- Before you lift or reposition your monitor, it is better to disconnect the cables and power cord. Follow the correct lifting techniques when positioning the monitor. When lifting or carrying the monitor, grasp the edges of the monitor. Do not lift the display by the stand or the cord.
- Cleaning. Turn your monitor off and unplug the power cord. Clean the monitor surface with a lint-free, non-abrasive cloth. Stubborn stains may be removed with a cloth dampened with mild cleaner.
- Avoid using a cleaner containing alcohol or acetone. Use a cleaner intended for use with the LCD. Never spray cleaner directly on the screen, as it may drip inside the monitor and cause an electric shock.

### **The following symptoms are normal with the monitor:**

- The screen may flicker during the initial use due to the nature of the fluorescent light. Turn off the Power Switch and turn it on again to make sure that the flicker disappears.
- You may find slightly uneven brightness on the screen depending on the desktop pattern you use.
- When the same image is displayed for hours, an afterimage of the previous screen may remain after switching the image. The screen will recover slowly or you can turn off the Power Switch for hours.
- When the screen becomes black or flashes, or cannot work anymore, contact your dealer or service center to fix it. Do not repair the screen by yourself!

### **Conventions used in this guide**



**WARNING:** Information to prevent injury to yourself when trying to complete a task.



**CAUTION:** Information to prevent damage to the components when trying to complete a task.



**IMPORTANT:** Information that you **MUST** follow to complete a task.



**NOTE:** Tips and additional information to aid in completing a task.

## Where to find more information

Refer to the following sources for additional information and for product and software updates.

### 1. ASUS websites

The ASUS websites worldwide provide updated information on ASUS hardware and software products. Refer to <http://www.asus.com>

### 2. Optional documentation

Your product package may include optional documentation that may have been added by your dealer. These documents are not part of the standard package.



### Disposal of waste equipment by user in private household in the European Union

This symbol on the product or on its packaging indicates that this product must not be disposed of with your other household waste. Instead, it is your responsibility to dispose of your waste equipment by handing it over to a designated collection point for the recycling of waste electrical and electronic equipment. The separate collection and recycling of your waste equipment at the time of disposal will help to conserve natural resources and ensure that it is recycled in a manner that protects human health and the environment. For more information about where you can drop off your waste equipment for recycling, please contact your local city office, your household waste disposal service or the shop where you purchased the product.



Product information for EU energy label



## Prevent Tipping

When using the display, fasten the LCD to a wall using a cord or chain that can support the weight of the monitor in order to prevent the monitor from falling.

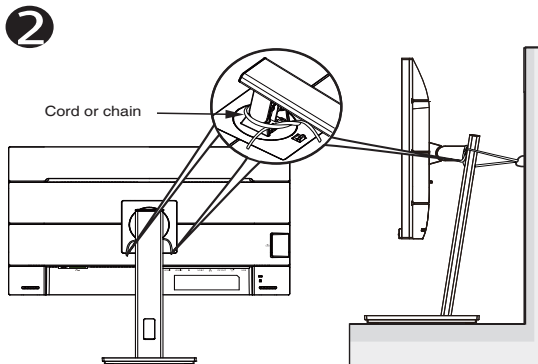
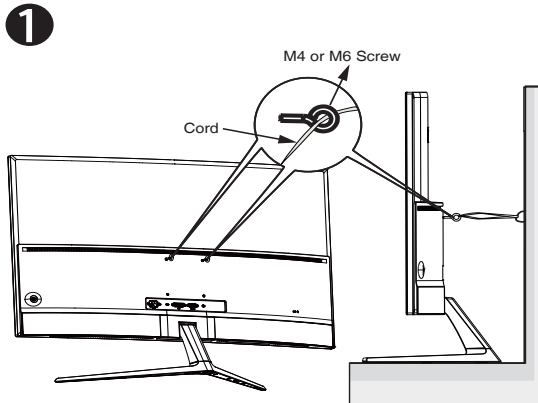

- Display design may differ from those illustrated.
- Installing must be done by a qualified technician , and please contact your supplier for more information.
- For the Models with net weight  $\geq 7\text{kg}$ . Please select the suitable way to Prevent Tipping.
- For the models with VESA Mount, please use method **1**, install the screws with ring to the VESA Mount hole, then tie the cord or chain to the wall. Otherwise, please use method **2** to tie the cord or chain to the stand and then fix it to the wall.

## 1.1 Welcome

Thank you for purchasing the ASUS® LCD monitor!

The latest widescreen LCD monitor from ASUS provides a crisper, broader, and brighter display, plus a host of features that enhance your viewing experience.

With these features, you can enjoy the convenience and delightful visual experience that the monitor brings you!

## 1.2 Package contents

Check your package for the following items:

- ✓ LCD Monitor
- ✓ Monitor Base
- ✓ Quick Start Guide
- ✓ Warranty Card
- ✓ 1x Power Cord
- ✓ 1x HDMI Cable (optional)
- ✓ 1x DP Cable (optional)
- ✓ 1x Type-C Cable (optional)



- 
- If any of the above items is damaged or missing, contact your retailer immediately.
-

## 1.3 Assembling the monitor

### To assemble the monitor

1. Place the display flat on a cloth on the table, Then attach the base to the arm and fix with the screw to join them tightly. You can easily tighten the screw by fingers.
2. Adjust the monitor to the angle that is most comfortable for you.

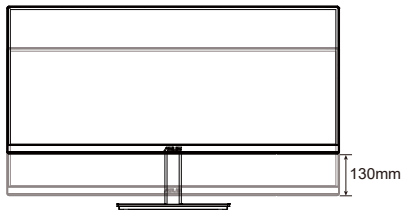
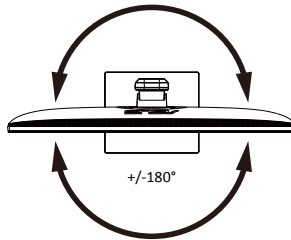
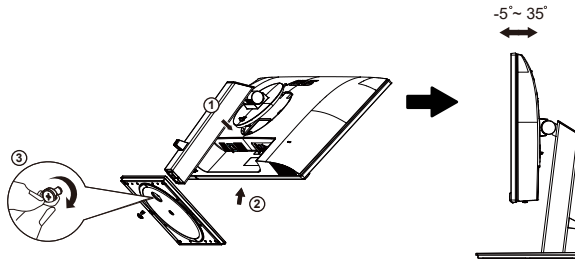

\*Base screw size: M6 x 14mm

## 1.4 Connect cables

### 1.4.1 Rear of the LCD monitor

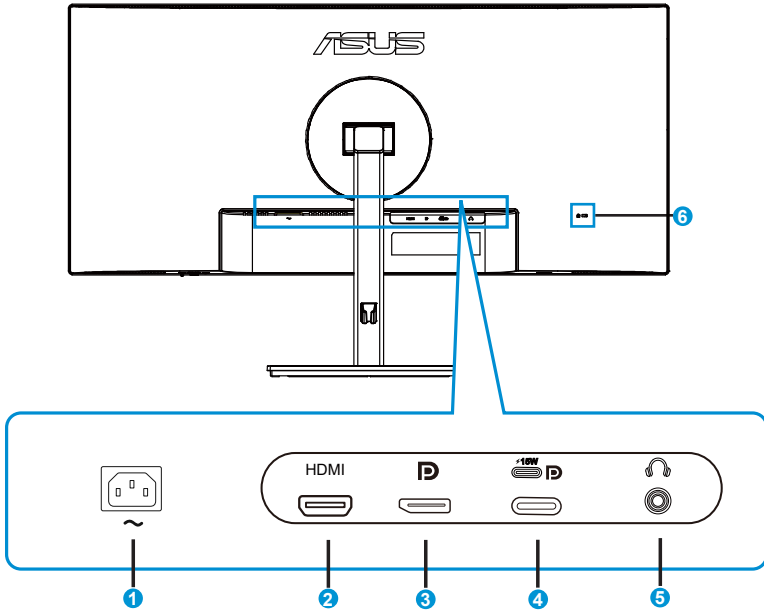

1. AC-IN Port
2. HDMI Port
3. DisplayPort
4. Type-C Port
5. Audio - out Port
6. Kensington Lock

## 1.5 Monitor introduction

### 1.5.1 Using the Controls button

Use the control button on the back of the monitor to adjust the image settings.

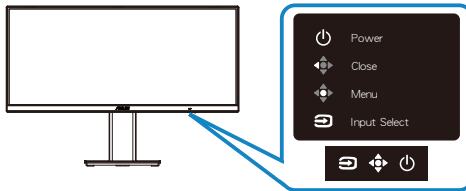

1. Power Indicator:

- The color definition of the power indicator is as the below table.

Status	Description
White	ON
Amber	Standby mode
OFF	OFF

2.  Power Button:

- Press this button to turn the monitor on/off.

3.  (5-way) Button:

- Press this button to turn on the OSD menu.
- Turns on the start menu. Execute the selected OSD menu item.
- Increases/Decreases values or moves your selection up/down/left/right

4.  Input Select Button

- This is a hotkey. The default setting is Input Select. Use Input Select hotkey to switch from “HDMI”, “DisplayPort” or “USB Type-C”

## 2.1 Detaching the arm/stand (for VESA wall mount)

The detachable stand of this monitor is specially designed for VESA wall mount.

### To detach the arm/stand

1. Disconnect power and signal cables. Carefully put the front of the monitor face down on a clean table.
2. Press the quick release button from rear cover, and then detach the arm/stand from the monitor.



- We recommend that you cover the table surface with soft cloth to prevent damage to the monitor.
- Hold the stand of the monitor while removing the screws.

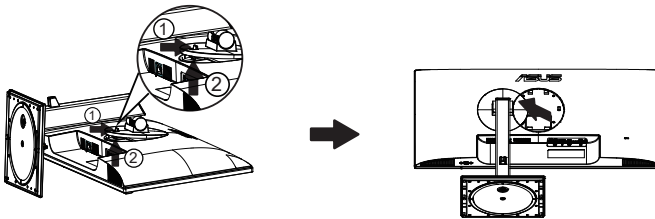

## 2.2 Adjusting the monitor

- For optimal viewing, we recommend that you look at the full face of the monitor, then adjust the monitor to the angle that is most comfortable for you.
- Hold the stand to prevent the monitor from falling when you change its angle.
- You can adjust the monitor's angle from  $+35^\circ$  to  $-5^\circ$ .

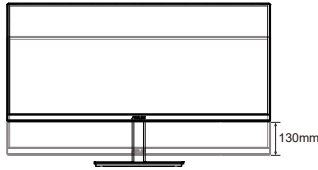
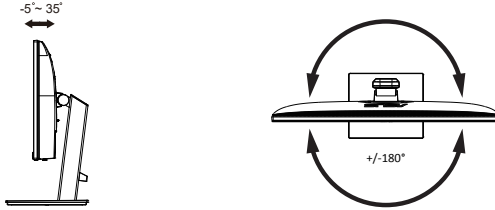

---

It is normal that the monitor slightly shakes while you adjust the viewing angle.

---

## 2.3 Outline dimension

Unit: mm [inch]

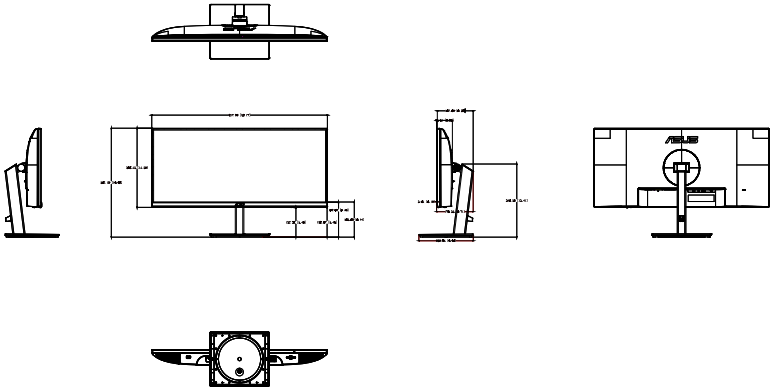



## 3.1 OSD (On-Screen Display) menu

### 3.1.1 How to reconfigure

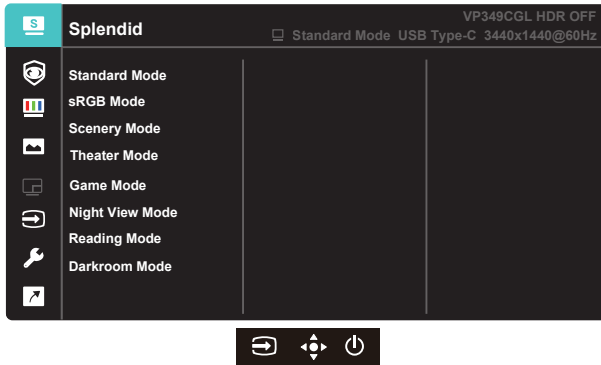

1. Press the MENU button to activate the OSD menu.
2. Press the ▼ and ▲ buttons to toggle between options in the Menu. As you move from one icon to another, the option name is highlighted.
3. To select the highlighted item on the menu press the Center key.
4. Press the ▼ and ▲ buttons to select the desired parameter.
5. Press the Center key to enter the slide bar and then use the ▼ or ▲ buttons, according to the indicators on the menu, to make your changes.
6. Press the ◀/▶ to move left / right menu.

### 3.1.2 OSD Function Introduction

#### 1. Splendid

This function contains eight sub-functions that you can select for your preference. Each mode has the Reset selection, allowing you to maintain your setting or return to the preset mode.

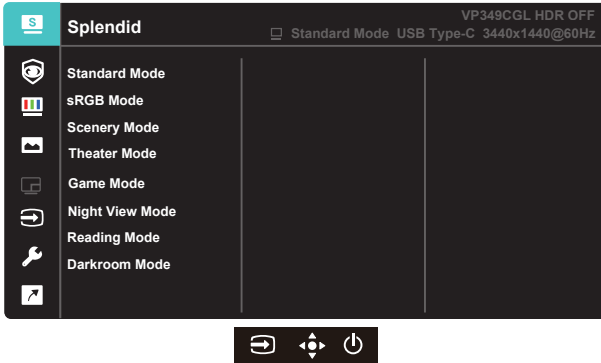

- **Standard Mode:** This is the best choice for document editing with SPLENDID™ Video Intelligence Technology.
- **sRGB Mode:** This is the best choice for viewing photos and graphics from PCs.
- **Scenery Mode:** This is the best choice for scenery photo displaying with SPLENDID™ Video Intelligence Technology.
- **Theater Mode:** This is the best choice for movie watching with SPLENDID™ Video Intelligence Technology.
- **Game Mode:** This is the best choice for game playing with SPLENDID™ Video Intelligence Technology.
- **Night View Mode:** This is the best choice for playing dark-scene game or watching dark-scene movie with SPLENDID™ Video Intelligence Technology.
- **Reading Mode :** This is the best choice for book reading.
- **Darkroom Mode :** This is the best choice for a weak ambient light environmen.



- 
- In the Standard Mode, the Saturation, SkinTone, Sharpness, and ASCR functions are not user-configurable.
  - In the sRGB, the Saturation, Color Temp., SkinTone, Sharpness, Brightness, Contrast and ASCR functions are not user-configurable.
  - In the Reading Mode, the Saturation, SkinTone, ASCR, contrast, and Color Temp functions are not user-configurable.
-

## 2. EyeCare

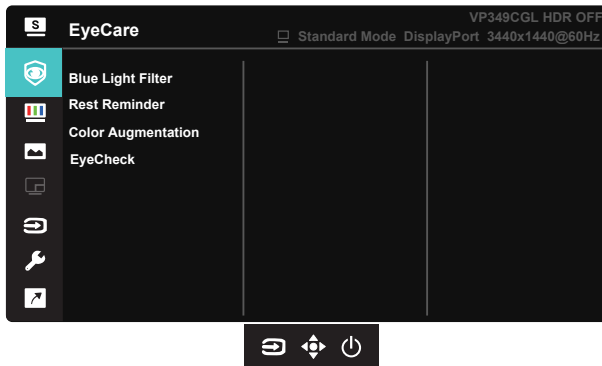

- **Blue Light Filter:** In this function, you can adjust the blue light filter from 0 to max. 0: no changes; Max: The higher the level, the less blue light is scattered. When blue light filter is activated, the default settings of Standard Mode will be automatically imported. Besides maximum level, the brightness is user-configurable. Maximum is the optimized setting. It is compliance with TUV low blue light certification\*. The brightness function is not user configurable.



- When the user adjusts blue light filter bar to maximum level.
- \*When color augmentation is in default value (50).

- **Rest Reminder:** This function provides you a rest reminder according to how long you set for your working time. For example, a user sets 60 minutes working time and there will be a pop up reminder appeared on the upper left corner of the monitor for 5 seconds. Press any key to make this reminder OSD disappeared.



- When this function is enable, the following functions are not available: Splendid Demo Mode, GamePlus and QuickFit.

- **Color Augmentation:** The adjusting range of color enhancement is from 0 to 100.



- This function is not available in sRGB mode under Splendid.
- This function is not available when Reddish or Yellowish is selected in the Skin Tone menu.

- **EyeCheck:** The EyeCheck function contains three patterns: (1) Snellen Chart (2) Amsler Grid (3) Astigmatism.

1. Snellen Chart

P1	P2	P3

2. Amsler Grid

While focusing at the center point, check that all the lines are straight.

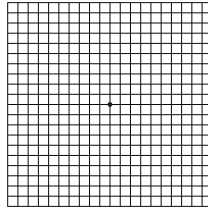

3. Astigmatism

Check that each line is of the same width.

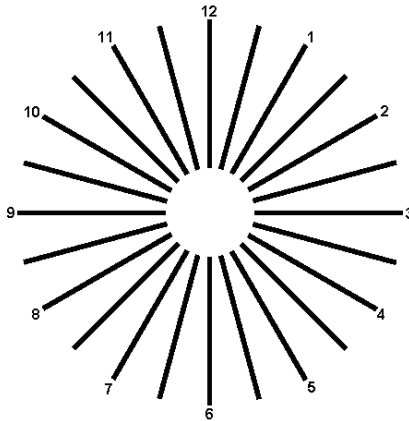



---

Please refer to the following to alleviate eye strains:

- Users should take some time away from the display if working for long hours. It is advised to take short breaks (at least 5 mins) after around 1 hour of continuous working at the computer. Taking short and frequent breaks is more effective than a single longer break.
  - To minimize eye strain and dryness in your eyes, users should rest the eye periodically by focusing on objects that are far away.
  - Eye exercises can help to reduce eye strain. Repeat these exercises often. If eye strain continues please consult a physician. Eye exercises: (1) Repeating look up and down (2) Slowly roll your eyes (3) Move your eyes diagonal.
  - High energy blue light may lead to eye strain and AMD (Age-Related Macular Degeneration). Blue light filter to reduce 70% (max.) harmful blue light to avoid CVS (Computer Vision Syndrome).
-

### 3. Color

Select the image color you like from this function.

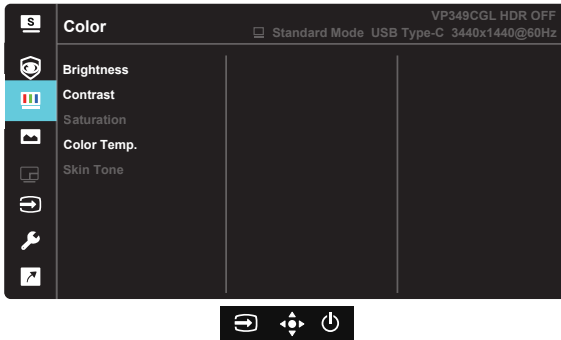

- **Brightness:** The adjusting range is from 0 to 100.
- **Contrast:** The adjusting range is from 0 to 100.
- **Saturation:** The adjusting range is from 0 to 100.
- **Color Temp.:** Contains three preset color modes (**Cool**, **Normal**, **Warm**) and **User Mode**.
- **Skin Tone:** Contains three color modes including **Reddish**, **Natural**, and **Yellowish**.



- 
- In the User Mode, colors of R (Red), G (Green), and B (Blue) are user-configurable; the adjusting range is from 0 ~ 100.
-

#### 4. Image

You can adjust the image Sharpness, Trace Free, Aspect Control, VividPixel, ASCR, Motion Sync, FreeSync, HDR, Shadow Boost from this main function.



- **Sharpness:** Adjusts the picture sharpness. The adjusting range is from 0 to 100.
- **Trace Free:** Speeds up the response time by Over Drive technology. The adjusting range is from lower 0 to faster 100.
- **Aspect Control:** Adjusts the aspect ratio to **“Full”**, **“4:3”**.
- **VividPixel:** ASUS Exclusive Technology that brings lifelike visuals for crystal-clear and detail-oriented enjoyment. The adjusting range is from 0 to 100.
- **ASCR:** Select **ON** or **OFF** to enable or disable dynamic contrast ratio function.
- **Motion Sync:** Check to decrease motion blur and minimize ghosting part when on-screen objects are fast moving. When this function is turned on, the screen may flash slightly and the brightness will decrease.

- **FreeSync:** It can allow a FreeSync supported graphics source to dynamically adjust display refresh rate based on typical content frame rates for power efficient, virtually stutter free and low-latency display update.
- **More:** Return the next page of Image Setting.
- **Back:** Return the previous page of Image Setting.
- **HDR:** High Dynamic Range. Contains two HDR modes (ASUS Cinema HDR and ASUS Gaming HDR).
- **Shadow Boost:** Dark color enhancement adjust monitor gamma curve to enrich the dark tones in an image making dark scenes and objects much easier be found.



- 
- 4:3 is only available when input source is in 4:3 format.
- 

## 5. PIP/PBP Setting

The PIP/PBP Setting allows you to open up another sub-window connected from another video source besides the main-window from your original video source.

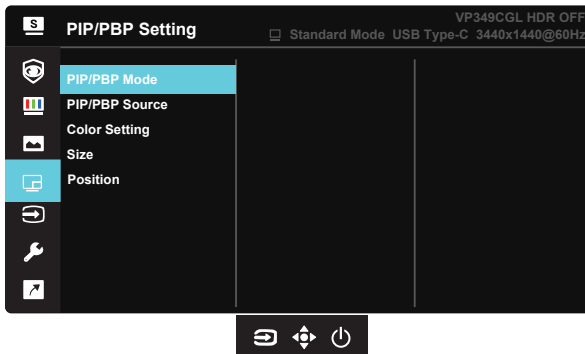

By activating this function, this monitor displays two pictures from two different video sources.

- **PIP/PBP Mode:** Selects PIP or PBP function, or turn it off.
- **PIP/PBP Source:** Selects the video input source among, “HDMI”, “DisplayPort” or “USB Type-C”.
- **Color Setting:** Set Splendid mode for each PIP/PBP window.
- **Size:** Adjust the PIP size to “Small”, “Middle”, or “Large”.
- **Position:** Adjusts the position of PIP sub-window to “Right-Top”, “Left-Top”, “Right-Bottom” or “Left-Bottom”.



## 6. Input Select

Select the input source from **HDMI**, **DisplayPort**, **USB Type-C** input signal.

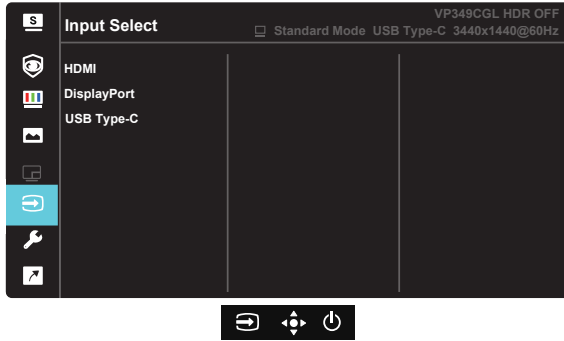

## 7. System Setup

Adjusts the system configuration.

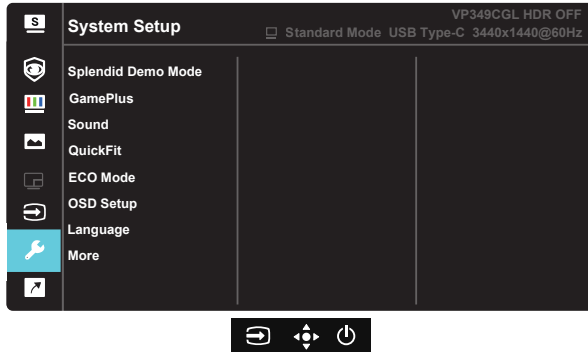

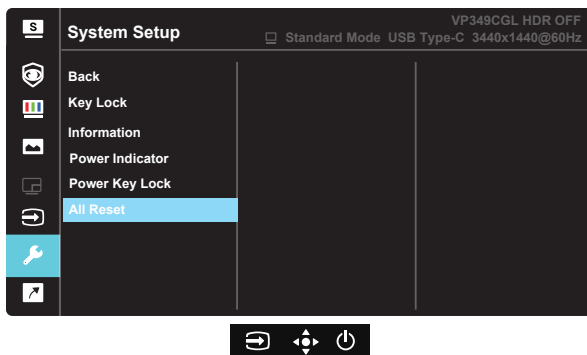

- **Splendid Demo Mode:** Activate the demo mode for the Splendid function.
- **GamePlus:** The GamePlus Function provides a toolkit and creates a better gaming environment for users when playing different types of games. Particularly, Crosshair function is specially designed for new gamers or beginners interested in First Person Shooter (FPS) games.

To active GamePlus:

- Press **GamePlus** Button to enter the GamePlus main menu.
- Activate Crosshair, Timer, FPS Counter or Display Alignment function.
- Move the button up/down to select and press to confirm the function needed. Press button left to go off, and exit.
- Crosshair/Timer/FPS Counter is movable by pressing 5-way key.

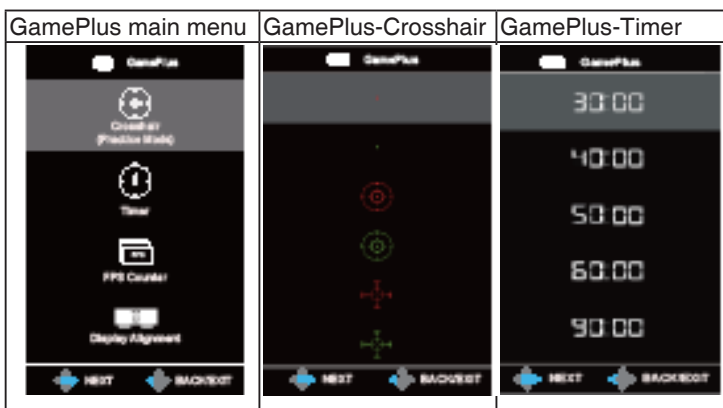

**Sound** : Adjust the sound settings to your preference.

- **QuickFit:**

The QuickFit function contains three patterns: (1) Grid (2) Paper size (3) Photo size.

1. Grid pattern: Facilitates designers and users to organize content and layout on one page and achieve a consistent look and feel.

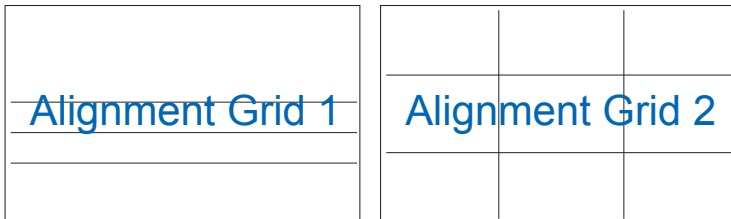

2. Paper size: Provides users to view their documents in real size on the screen.

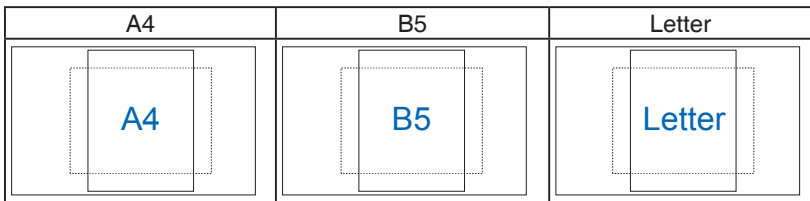

3. Photo size: Provides photographers and other users to accurately view and edit their photos in real size on the screen.

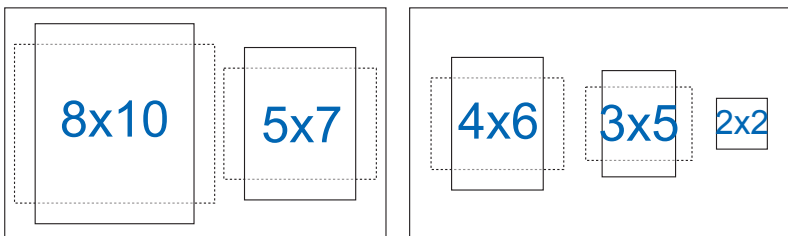

- **ECO Mode:** Activate the ecology mode for power saving.
- **OSD Setup:** Adjusts the **OSD Timeout**, **DDC/CI**, and **Transparency** of the OSD screen.

- **Language:** Select OSD language. The selections are: **English, French, German, Spanish, Italian, Dutch, Russian, Poland, Czech, Croacia, Hungary, Romania, Portugal, Turkey, Simplified Chinese, Traditional Chinese, Japanese, Korean, Persian, Thai, and Indonesian.**
- **More:** Return the next page of System Setting.
- **Back:** Return the previous page of System Setting.
- **Key Lock:** Disable all key functions. Pressing the second button on the right for more than five seconds to disable key lock function.
- **Information:** Displays the monitor information.
- **Power Indicator:** Turn the power LED indicator on/off.
- **Power Key Lock:** To disable / enable power key
- **All Reset:** Selects "**Yes**" to revert all settings to the factory default mode.

## 8. Shortcut

Selecting this option allows you to set one shortcut key.

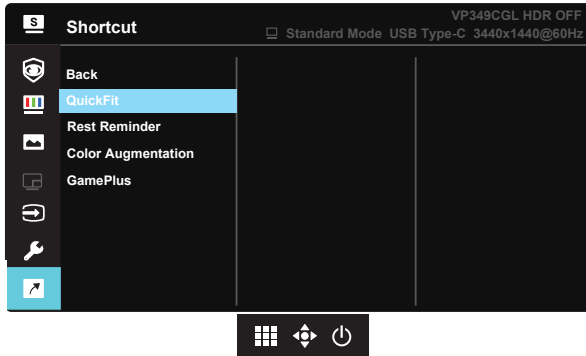
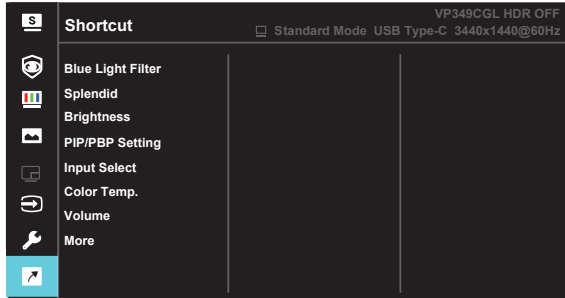

- **Shortcut** : User can select from “Blue Light Filter” “Splendid”, “Brightness”, “PIP/PBP Setting”, “Input Select”, “Color Temp.”, “Volume”, “QuickFit”, “Rest Reminder”, “Color Augmentation”, “GamePlus” and set as shortcut key. The default setting is Input Select.

## 3.2 Specifications

<b>Model</b>	VP349CGL
Panel Size	34 (86.7cm)
Max. Resolution	3440 x 1440 (UWQHD)
Brightness (Typ)	300cd/m <sup>2</sup>
Intrinsic Contrast Ratio (Typ.)	1000:1
Viewing Angle (CR>10)	178°(H) /178°(V)
Display Colors	16.7 M
Response Time	1MS(MPRT)
Satellite Speaker	Yes(2W x 2)
Sound from HDMI/DP/Type-c	Yes
Type-C input	Yes
DisplayPort input	Yes
HDMI input	Yes
Earphone jack	3.5mm Mini-jack
Power ON Consumption	<34W
Power saving mode	<0.5W
Power off mode	< 0.3W
Voltage Rating	AC 100~240V(Built-in), 1.5A
Tilt	-5° ~ +35°
VESA Wall Mounting	Yes (100mm x 100mm)
Phys. Dimension (WxHxD)	817.2 x 507.12 x 252.94 mm (highest) 817.2 x 382.11 x 252.94 mm (lowest)
Box Dimension (WxHxD)	980 mm * 498mm * 224 mm
Net Weight (Esti.)	9.27 kg (Net); 6.37 kg (without stand)
Gross Weight (Esti.)	12.4kg

### 3.3 Troubleshooting (FAQ)

Problem	Possible Solution
Power LED is not ON	<ul style="list-style-type: none"><li>• Press the  button to check if the monitor is in the ON mode.</li><li>• Check if the power cord is properly connected to the monitor and the power outlet.</li><li>• Check Power Indicator function in main menu OSD. Select "ON" to turn on power LED.</li></ul>
The power LED lights amber and there is no screen image	<ul style="list-style-type: none"><li>• Check if the monitor and the computer are in the ON mode.</li><li>• Make sure the signal cable is properly connected the monitor and the computer.</li><li>• Inspect the signal cable and make sure none of the pins are bent.</li><li>• Connect the computer with another available monitor to check if the computer is properly working.</li></ul>
Screen image is too light or dark	<ul style="list-style-type: none"><li>• Adjust the Contrast and Brightness settings via OSD.</li></ul>
Screen image bounces or a wave pattern is present in the image	<ul style="list-style-type: none"><li>• Make sure the signal cable is properly connected to the monitor and the computer.</li><li>• Move electrical devices that may cause electrical interference.</li></ul>
Screen image has color defects (white does not look white)	<ul style="list-style-type: none"><li>• Inspect the signal cable and make sure that none of the pins are bent.</li><li>• Perform Reset via OSD.</li><li>• Adjust the R/G/B color settings or select the Color Temperature via OSD.</li></ul>
No sound or sound is low	<ul style="list-style-type: none"><li>• Make sure the audio cable is properly connected to the monitor.</li><li>• Adjust the volume settings of both your monitor and computer.</li><li>• Make sure the computer sound card driver is properly installed and activated.</li><li>• Make sure the audio source is correct on the OSD.</li></ul>

### 3.4 Supported Timing List

#### PC Supported Primary Timing

Timing	H Pixels	V Pixels	Frame Rate	HDMI	Type-c	DP
PC Timing	720	400	70	V	V	V
PC Timing	640	480	60	V	V	V
PC Timing	640	480	67	V	V	V
PC Timing	640	480	72	V	V	V
PC Timing	640	480	75	V	V	V
PC Timing	800	600	56	V	V	V
PC Timing	800	600	60	V	V	V
PC Timing	800	600	72	V	V	V
PC Timing	800	600	75	V	V	V
PC Timing	832	624	75	V	V	V
PC Timing	1024	768	60	V	V	V
PC Timing	1024	768	70	V	V	V
PC Timing	1024	768	75	V	V	V
PC Timing	1280	1024	75	V	V	V
Standard Timing	1280	960	60	V	V	V
Standard Timing	1280	1024	60	V	V	V
Standard Timing	1440	900	60	V	V	V
Standard Timing	1152	864	75	V	V	V
Standard Timing	1280	720	60	V	V	V
Standard Timing	1680	1050	60	V	V	V
Standard Timing	1920	1080	60	V	V	V
Vedio Timing	640	480P 4:3	59.94/60	V	V	V
Vedio Timing	720	480P 4:3	59.94/60	V	V	V
Vedio Timing	720	480P 16:9	59.94/60	V	V	V
Vedio Timing	720	576P 16:9	50	V	V	V
Vedio Timing	1280	720P 16:9	50	V	V	V
Vedio Timing	1280	720P 16:9	59.94/60	V	V	V
Vedio Timing	1440	480P 4:3	59.94/60	V	V	V
Vedio Timing	1440	480P 16:9	59.94/60	V	V	V
Vedio Timing	1440	576P 4:3	50	V	V	V
Vedio Timing	1440	576P 16:9	50	V	V	V
Vedio Timing	1920	1080P 16:9	50	V	V	V
Vedio Timing	1920	1080P 16:9	59.94/60	V	V	V
Vedio Timing	2560	1080P 64:27	60	V	V	V
Vedio Timing	3840	2160P 16:9	50	V	X	X
Vedio Timing	3840	2160P 16:9	60	V	X	X
Detail Timing	3440	1440	60	V	V	V
Detail Timing	3440	1440	100	V	V	V
Detail Timing	3440	1440	30	V	V	V
Detail Timing	1720	1440	60	V	V	V

\* The modes not listed in the above tables may not be supported. For optimal resolution, we recommend that you choose a mode listed in the above tables.