



ESC8000 G4 Series

4U Rackmount Server

User Guide



E15582
Revised Edition V6
June 2019

Copyright © 2019 ASUSTeK COMPUTER INC. All Rights Reserved.

No part of this manual, including the products and software described in it, may be reproduced, transmitted, transcribed, stored in a retrieval system, or translated into any language in any form or by any means, except documentation kept by the purchaser for backup purposes, without the express written permission of ASUSTeK COMPUTER INC. ("ASUS").

ASUS provides this manual "as is" without warranty of any kind, either express or implied, including but not limited to the implied warranties or conditions of merchantability or fitness for a particular purpose. In no event shall ASUS, its directors, officers, employees, or agents be liable for any indirect, special, incidental, or consequential damages (including damages for loss of profits, loss of business, loss of use or data, interruption of business and the like), even if ASUS has been advised of the possibility of such damages arising from any defect or error in this manual or product.

Specifications and information contained in this manual are furnished for informational use only, and are subject to change at any time without notice, and should not be construed as a commitment by ASUS. ASUS assumes no responsibility or liability for any errors or inaccuracies that may appear in this manual, including the products and software described in it.

Product warranty or service will not be extended if: (1) the product is repaired, modified or altered, unless such repair, modification or alteration is authorized in writing by ASUS; or (2) the serial number of the product is defaced or missing.

Products and corporate names appearing in this manual may or may not be registered trademarks or copyrights of their respective companies, and are used only for identification or explanation and to the owners' benefit, without intent to infringe.

Contents

Safety information.....	viii
About this guide.....	ix

Chapter 1: Product Introduction

1.1	System package contents	1-2
1.2	Serial number label.....	1-3
1.3	System specifications	1-4
1.4	Front panel features.....	1-7
1.5	Rear panel features.....	1-7
1.6	Internal features	1-8
1.7	LED information	1-9
1.7.1	Front panel LEDs	1-9
1.7.2	LAN (RJ-45) LEDs	1-10
1.7.3	Storage device status LED.....	1-11

Chapter 2: Hardware Setup

2.1	Chassis cover.....	2-2
2.1.1	Air duct.....	2-4
2.2	Central Processing Unit (CPU)	2-6
2.2.1	Installing the CPU and cooler.....	2-6
2.3	System memory	2-9
2.3.1	Overview	2-9
2.3.2	Memory Configurations.....	2-10
2.3.3	Installing a DIMM on a single clip DIMM socket.....	2-17
2.4	Storage devices.....	2-18
2.4.1	Installing 2.5-inch SATA HDD/SAS storage devices.....	2-18
2.5	Expansion slots.....	2-20
2.5.1	The PCI Express riser card.....	2-20
2.5.2	Installing an ASUS PIKE II card.....	2-23
2.5.3	Installing an M.2 expansion card.....	2-28
2.6	Cable connections	2-30
2.7	Removable/optional components.....	2-33
2.7.1	GPU fans.....	2-33
2.7.2	Redundant power supply units.....	2-34
2.8	Installing GPU cards	2-36

Contents

Chapter 3: Installation Options

3.1	Rail Kit	3-2
3.1.1	Selecting rack rail cabinets	3-2
3.1.2	Attaching the rack rails	3-3
3.2	Cable management arm (optional for 1200 mm rack rails)	3-8
3.2.1	Attaching the cable management arm	3-8

Chapter 4: Motherboard Information

4.1	Z11PG-D24 Series Motherboard layout	4-2
4.2	Jumpers	4-4
4.3	Internal LEDs	4-9
4.4	Internal connectors	4-11

Chapter 5: BIOS Setup

5.1	Managing and updating your BIOS	5-2
5.1.1	ASUS CrashFree BIOS 3 utility.....	5-2
5.1.2	ASUS EZ Flash Utility	5-3
5.1.3	BUPTATER utility	5-4
5.2	BIOS setup program	5-6
5.2.1	BIOS menu screen.....	5-7
5.2.2	Menu bar	5-7
5.2.3	Menu items.....	5-8
5.2.4	Submenu items	5-8
5.2.5	Navigation keys.....	5-8
5.2.6	General help.....	5-8
5.2.7	Configuration fields	5-8
5.2.8	Pop-up window.....	5-8
5.2.9	Scroll bar	5-8
5.3	Main menu	5-9
5.3.1	System Date [Day xx/xx/xxxx].....	5-9
5.3.2	System Time [xx:xx:xx]	5-9
5.4	Ai Tweaker	5-10
5.4	Performance Tuning menu	5-13

Contents

5.5	Advanced menu	5-14
5.5.1	Trusted Computing.....	5-15
5.5.2	ACPI Settings.....	5-15
5.5.3	Smart Settings.....	5-16
5.5.4	Super IO Configuration	5-16
5.5.5	Serial Port Console Redirection	5-17
5.5.6	Onboard LAN Configuration	5-20
5.5.7	APM	5-21
5.5.8	PCI Subsystem Settings	5-22
5.5.9	USB Configuration	5-24
5.5.10	CSM Configuration.....	5-25
5.5.11	NVMe Configuration.....	5-26
5.5.12	Network Stack Configuration.....	5-26
5.5.13	iSCSI Configuration.....	5-27
5.6	Platform Configuration menu	5-27
5.6.1	PCH Configuration	5-28
5.6.2	Miscellaneous Configuration	5-30
5.6.3	Server ME Configuration.....	5-30
5.6.4	Runtime Error Logging Support	5-31
5.7	Socket Configuration menu	5-31
5.7.1	Processor Configuration.....	5-32
5.7.2	Common RefCode Configuration.....	5-33
5.7.3	UPI Configuration.....	5-34
5.7.4	Memory Configuration.....	5-35
5.7.5	IIO Configuration	5-37
5.7.6	Advanced Power Management Configuration.....	5-38
5.8	Event Logs menu	5-40
5.8.1	Change Smbios Event Log Settings	5-40
5.8.2	View Smbios Event Log	5-40
5.9	Server Mgmt menu	5-41
5.10	Security menu	5-42
5.11	Boot menu	5-45
5.12	Tool menu	5-46
5.13	Save & Exit menu	5-46

Contents

Chapter 6: RAID Configuration

6.1	Setting up RAID	6-2
6.1.1	RAID definitions	6-2
6.1.2	Installing hard disk drives.....	6-3
6.1.3	Setting the RAID item in BIOS	6-3
6.1.4	RAID configuration utilities.....	6-3
6.2	Intel® Rapid Storage Technology enterprise SATA Option ROM Utility	6-4
6.2.1	Creating a RAID set.....	6-5
6.2.2	Deleting a RAID set.....	6-7
6.2.3	Resetting disks to Non-RAID	6-8
6.2.4	Exiting the Intel® Rapid Storage Technology enterprise SATA Option ROM utility.....	6-9
6.2.5	Rebuilding the RAID.....	6-9
6.2.6	Setting the Boot array in the BIOS Setup Utility.....	6-11
6.3	Intel® Rapid Storage Technology enterprise (Windows)	6-12
6.3.1	Creating a RAID set.....	6-13
6.3.2	Changing a Volume Type.....	6-15
6.3.3	Deleting a volume	6-16
6.3.4	Preferences.....	6-17

Chapter 7: Driver Installation

7.1	RAID driver installation	7-2
7.1.1	Creating a USB flash drive with RAID drive	7-2
7.1.2	Installing the RAID controller driver.....	7-2
7.2	Management applications and utilities installation	7-5
7.3	Running the Support DVD	7-5
7.4	Intel® chipset device software installation	7-8
7.5	VGA driver installation	7-10
7.6	Intel® Rapid Storage Technology enterprise installation	7-12

Contents

Appendix

ESC8000 G4 block diagram (Single Root)	2
ESC8000 G4 block diagram (Dual Root)	2
ESC8000 G4/10G block diagram (Single Root)	3
ESC8000 G4/10G block diagram (Dual Root)	3
Changing System PCI-E Topology	4
Q-Code table	6
Notices	9
REACH	10
Australia statement notice.....	10
ASUS contact information.....	11

Safety information

Electrical Safety

- Before installing or removing signal cables, ensure that the power cables for the system unit and all attached devices are unplugged.
- To prevent electrical shock hazard, disconnect the power cable from the electrical outlet before relocating the system.
- When adding or removing any additional devices to or from the system, ensure that the power cables for the devices are unplugged before the signal cables are connected. If possible, disconnect all power cables from the existing system before you add a device.
- If the power supply is broken, do not try to fix it by yourself. Contact a qualified service technician or your dealer.

Operation Safety

- Any mechanical operation on this server must be conducted by certified or experienced engineers.
- Before operating the server, carefully read all the manuals included with the server package.
- Before using the server, ensure all cables are correctly connected and the power cables are not damaged. If any damage is detected, contact your dealer as soon as possible.
- To avoid short circuits, keep paper clips, screws, and staples away from connectors, slots, sockets and circuitry.
- Avoid dust, humidity, and temperature extremes. Place the server on a stable surface.



This product is equipped with a three-wire power cable and plug for the user's safety. Use the power cable with a properly grounded electrical outlet to avoid electrical shock.

Lithium-Ion Battery Warning

CAUTION! Danger of explosion if battery is incorrectly replaced. Replace only with the same or equivalent type recommended by the manufacturer. Dispose of used batteries according to the manufacturer's instructions.

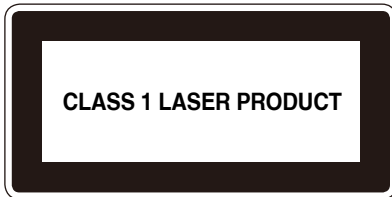

Heavy System

CAUTION! This server system is heavy. Ask for assistance when moving or carrying the system.

About this guide

Audience

This user guide is intended for system integrators, and experienced users with at least basic knowledge of configuring a server.

Contents

This guide contains the following parts:

1. Chapter 1: Product Introduction

This chapter describes the general features of the server, including sections on front panel and rear panel specifications.

2. Chapter 2: Hardware Setup

This chapter lists the hardware setup procedures that you have to perform when installing or removing system components.

3. Chapter 3: Installation Options

This chapter describes how to install optional components into the barebone server.

4. Chapter 4: Motherboard Information

This chapter gives information about the motherboard that comes with the server. This chapter includes the motherboard layout, jumper settings, and connector locations.

5. Chapter 5: BIOS Setup

This chapter tells how to change system settings through the BIOS Setup menus and describes the BIOS parameters.

6. Chapter 6: RAID Configuration

This chapter tells how to change system settings through the BIOS Setup menus. Detailed descriptions of the BIOS parameters are also provided.

7. Chapter 7: Driver Installation

This chapter provides instructions for installing the necessary drivers for different system components.

Conventions

To ensure that you perform certain tasks properly, take note of the following symbols used throughout this manual.



DANGER/WARNING: Information to prevent injury to yourself when trying to complete a task.



CAUTION: Information to prevent damage to the components when trying to complete a task.



IMPORTANT: Instructions that you **MUST** follow to complete a task.



NOTE: Tips and additional information to help you complete a task.

Typography

Bold text

Indicates a menu or an item to select.

Italics

Used to emphasize a word or a phrase.

<Key>

Keys enclosed in the less-than and greater-than sign means that you must press the enclosed key.

Example: <Enter> means that you must press the Enter or Return key.

<Key1>+<Key2>+<Key3>

If you must press two or more keys simultaneously, the key names are linked with a plus sign (+).

Example: <Ctrl>+<Alt>+

Command

Means that you must type the command exactly as shown, then supply the required item or value enclosed in brackets.

Example: At the DOS prompt, type the command line: **format A:/S**

References

Refer to the following sources for additional information, and for product and software updates.

1. **ASUS Control Center (ACC) user guide**

This manual tells how to set up and use the proprietary ASUS server management utility.

2. **ASUS websites**

The ASUS websites worldwide provide updated information for all ASUS hardware and software products. Refer to the ASUS contact information.

Product Introduction

1

This chapter describes the general features of the chassis kit. It includes sections on front panel and rear panel specifications.

1.1 System package contents

Check your system package for the following items.

ESC8000 G4 Series	
Chassis	ASUS 4U Rackmount Chassis
Motherboard	ASUS Z11PG-D24 Series Server Board
Accessory box	1 x MB Support DVD 1 x ACC instruction card 1 x ASMB9 instruction card 2 x Front PIKE II cables 1 x Bag of Screws 3 x AC Power Cables 8 x GPU air ducts (for Nvidia/AMD) 8 x Mylar for GPU air duct for AMD GPU 2 x CPU coolers 1 x Rail Kit 16 x VGA power cables 8 x ASUS CPU 8-pin Power cables 2 x CPU carriers
Optional Items	One Row SYS FAN (Redundant FAN-Optional) 1 x Redundant Power Supply Module 1 x Trend Micro Server Protect Anti-virus Software CD 1 x PIKE II RAID Card

- ASUS System Web-based Management



The system does not include a USB floppy drive. You may have to use a USB floppy drive when creating a SATA RAID driver disk. Refer to Chapter 6 for details.



If any of the above items is damaged or missing, contact your retailer.

1.2 Serial number label

Before requesting support from the ASUS Technical Support team, you must take note of the product's serial number containing 12 characters such as xxS0xxxxxxx. See the figure below.

With the correct serial number of the product, ASUS Technical Support team members can then offer a quicker and satisfying solution to your problems.

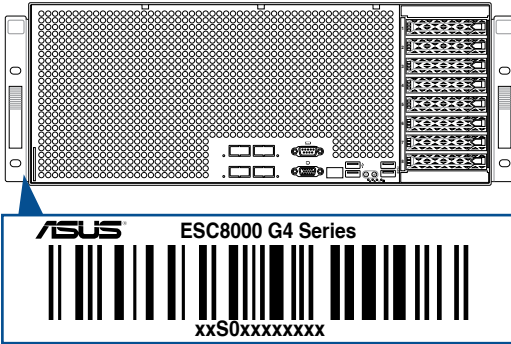

The serial number on the ESC8000 G4 Series is printed on the Asset tag.

1.3 System specifications

The ASUS ESC8000 G4 Series servers features the ASUS Z11PG-D24 Series server board. The server supports Intel® Xeon® Scalable Processors Family Series plus other latest technologies through the chipsets onboard.

Model Name		ESC8000 G4	ESC8000 G4/10G
Processor / System Bus		2 x Socket P0 (LGA 3647) 1st Gen Intel® Xeon® Processor Scalable Family 2nd Gen Intel® Xeon® Processor Scalable Family UPI 10.4 GT/s	
Core Logic		Intel® C621 PCH	
Memory	Total Slots	24 (6-channel per CPU, 12 DIMMs per CPU)	
	Capacity	Maximum up to 7680GB	
	Memory Type	DDR4 2933* (1 DIMM per Channel)	
		DDR4 2666/2400/2133 RDIMM/LRDIMM/LRDIMM 3DS (2DIMM per Channel)	
		Intel® Optane™ DC persistent memory (DCPMM) * 2933MHz will drop to 2666MHz when using 2DPC configurations ** Refer to ASUS server AVL for the latest update	
Memory Size	4GB, 8GB, 12GB, 32GB (RDIMM) 64GB, 128GB (RDIMM 3DS) 32GB, 64GB, 128GB (LRDIMM) 64GB, 128GB, 256GB (LRDIMM 3DS) 128GB, 256GB, 512GB (DCPMM) * Refer to ASUS server AVL for the latest update		
Expansion Slots	Total PCI/PCI-X/PCI-E Slots	11	
	Slot Type	8 x PCI-E x16 (Gen3 x16 link) , FH, FL Rear: Dual root topology: 2 x PCI-E x16 (Gen3 x 16 link), LP, HL or Single root topology: 1 X PCI-E x16 (Gen3 x16 link), LP, HL Front: 1 x PCI-E x8 (Gen3 x8 link) , LP, HL	
Storage	SATA Controller	Intel® C621 PCH - 8 x SATA 6Gb/s ports + 2 x M.2 connector (SATA 6Gb/s & PCI-E Gen3 x4 link, M.2 supports up to 22110) or 6 x SATA 6Gb/s ports + 2 x NVMe + 2 x M.2 connector (SATA 6Gb/s & PCI-E Gen3 x4 link, M.2 supports up to 22110) Intel® RSTe (Support software RAID 0, 1, 10 & 5)	

(continued on the next page)

Model Name		ESC8000 G4	ESC8000 G4/10G
Storage	SAS Controller	Optional kits: ASUS PIKE II 3008 8-port SAS HBA card ASUS PIKE II 3108 8-port SAS HW RAID card 12G SAS Support	
Storage Device Bays	I = Internal A or S will be hot-swappable	8 x Hot-swap 2.5-inch Storage Bays	
Networking	LAN	1 x Dual Port Intel I350-AM2 Gigabit LAN controller 1 x Management Port	1 x Dual Port Intel X550-AT2 10GBase-T LAN controller 1 x Management Port
Graphic	VGA	Aspeed AST2500 64MB	
Front I/O		2 x USB 3.0 ports 2 x USB 2.0 ports 1 x VGA port 1 x COM port	
Rear I/O		2 x RJ-45 GbE LAN ports 1 x RJ-45 Mgmt LAN port	
Switch/LED		Front Switch/LED: 1 x Q-Code/Port 80 LED 1 x Power switch/LED 1 x Location switch/LED 1 x Storage Device Access LED 1 x Message LED LAN 1-4 LED	
OS Support		Please find the latest OS support from http://www.asus.com/	

(continued on the next page)

Model Name		ESC8000 G4	ESC8000 G4/10G
Management Solution	Out of Band Remote Hardware	On-Board ASMB9-iKVM for KVM-over-IP	
	Software	ACC	
Regulatory Compliance		BSMI, CE, FCC (Class A)	
Dimension (HH x WW x DD)		798 mm x 439 mm x 175.6 mm (4U)	
Power Supply / Power Rating		2+1 Redundant 1600W 80 PLUS Platinum Power Supply Rating: 100-127 Vac / 200-240 Vac, 12.9/9.5 A (for each inlet), 47-63Hz, Class I 2+1 Redundant 2200W 80 PLUS Platinum Power Supply Rating: 100-127 Vac / 200-240 Vac, 12.9/9.5 A (for each inlet), 47-63Hz, Class I * 2200W Power supply is only available for selected countries	
Environment		Operating temperature: 10°C ~ 35°C Non operating temperature: -40°C ~ 70°C Non operating humidity: 20% ~ 90% (Non-condensing)	



-
- Specifications are subject to change without notice.
 - Refer to www.asus.com for the latest OS AVL update.
-

1.4 Front panel features

The barebone server features a simple yet stylish front panel. The power and reset buttons, LED indicators, and USB ports are located and easily accessible on the front panel.

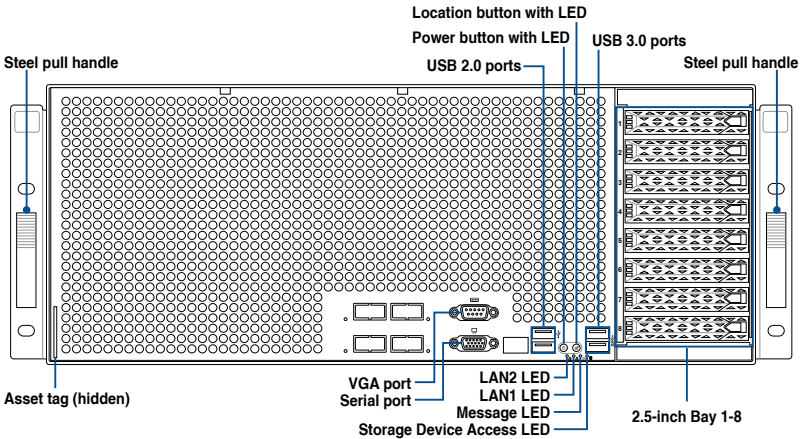

1.5 Rear panel features

The LAN ports and system power socket are located on the rear panel of the server.

Half-length/Low-profile expansion slot

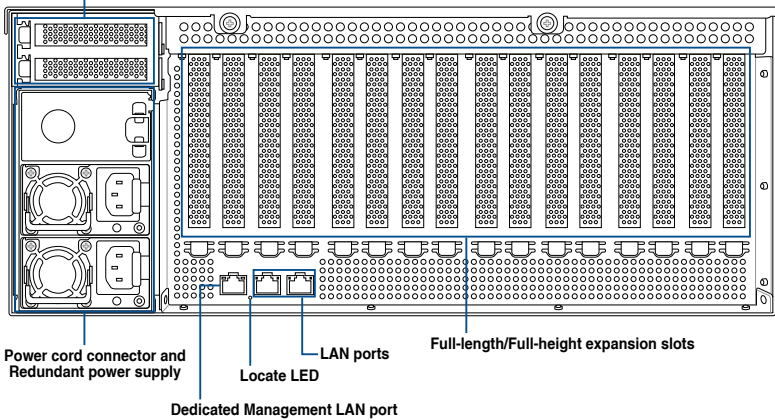

The Dedicated Management LAN port is for the ASUS ASMB9-iKVM only.

1.6 Internal features

The barebone server includes the basic components as shown.

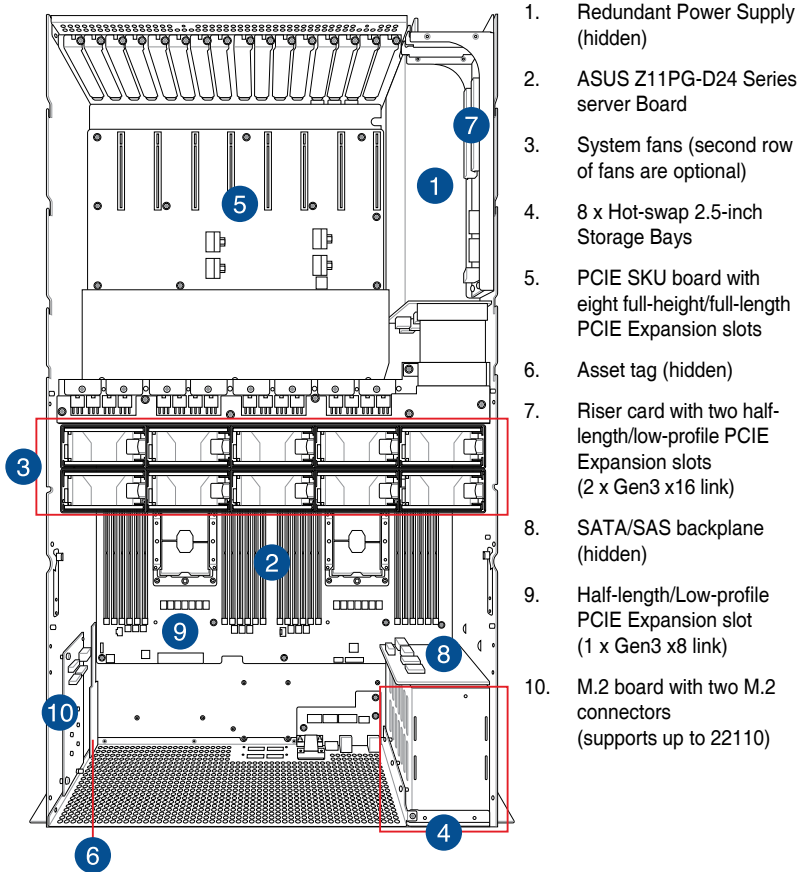

The barebone server does not include a floppy disk drive or an optical drive. Connect a USB floppy disk drive to any of the USB ports on the front or rear panel if you need to use a floppy disk.



A protection film is pre-attached to the front cover before shipping. Please remove the protection film before turning on the system for proper heat dissipation.

WARNING
HAZARDOUS MOVING PARTS
KEEP FINGERS AND OTHER BODY PARTS AWAY

1.7 LED information

1.7.1 Front panel LEDs

ESC8000 G4 Series

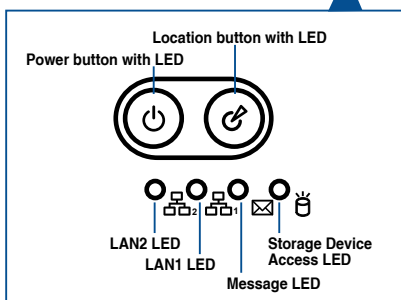
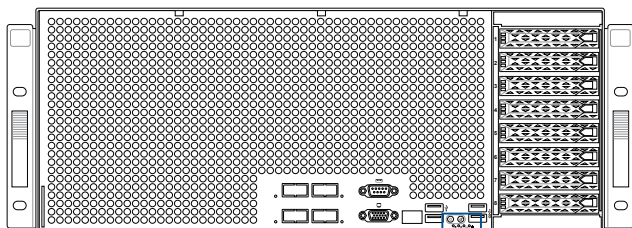

LED	Icon	Display status	Description
Power button with LED		ON	System power ON
Storage Device Access LED		OFF Blinking	No activity Read/write data into the storage device
Message LED		OFF ON	System is normal; no incoming event A hardware monitor event is indicated
Location button with LED		OFF ON	Normal status Location switch is pressed (Press the location switch again to turn off)
LAN LEDs		OFF Blinking ON	No LAN connection LAN is transmitting or receiving data LAN connection is present

1.7.2 LAN (RJ-45) LEDs

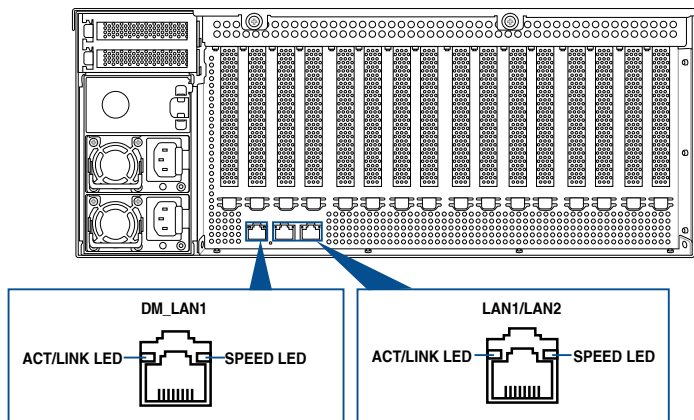

LAN1/LAN2 LEDs

ACT/LINK LED		SPEED LED	
Status	Description	Status	Description
OFF	No link	OFF	10 Mbps connection
GREEN	Linked	ORANGE	100 Mbps connection
BLINKING	Data activity	GREEN	1 Gbps connection

Dedicated Management LAN LEDs (for ASUS ASMB9-iKVM and DM_LAN1)

ACT/LINK LED		SPEED LED	
Status	Description	Status	Description
OFF	No link	OFF	10 Mbps connection
ORANGE	Linked	ORANGE	100 Mbps connection
BLINKING	Data activity	GREEN	1 Gbps connection

1.7.3 Storage device status LED

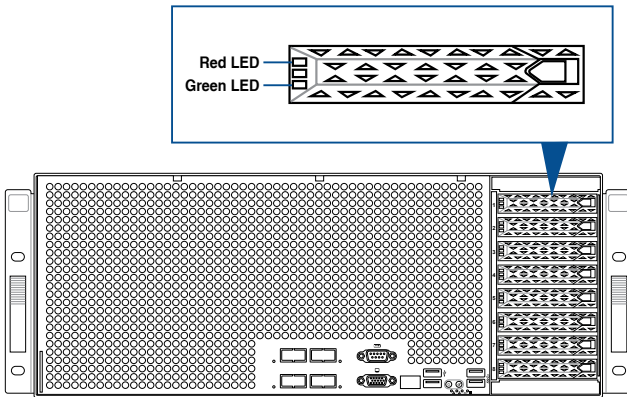

SATA/SAS Storage Device LED Description		
GREEN	ON	SATA/SAS storage device power ON
RED	ON	Storage device has failed and should be swapped immediately
GREEN/ RED	Blinking	RAID rebuilding
GREEN/ RED	Blinking	Locate
GREEN/ RED	OFF	Storage device not found
GREEN	Blinking	Read/write data from/into the SATA/SAS storage device

Hardware Setup

2

This chapter lists the hardware setup procedures that you have to perform when installing or removing system components.

2.1 Chassis cover

There are three parts of the chassis cover you may remove.



The diagrams in this section are for reference only. The system layout may vary with models, but the installation steps are the same for all models.

To remove the rear chassis cover:

1. Release the two (2) thumbscrews on the rear of the chassis.
2. Push and hold the cover buttons down.
3. Slide the chassis cover towards the rear to disengage it from the chassis and lift the chassis cover to completely remove it from the chassis.

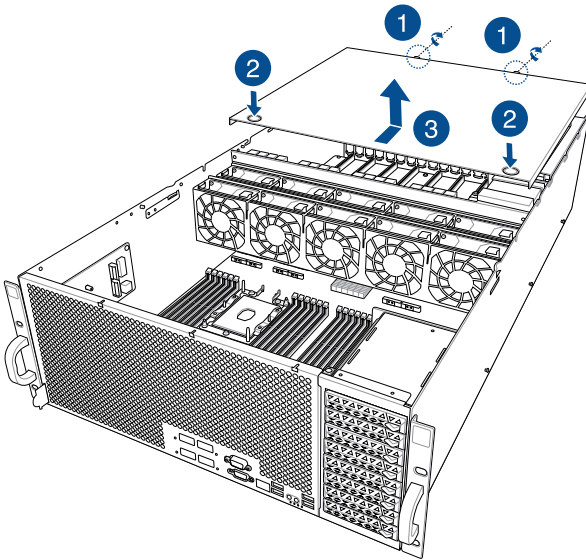

To remove the middle chassis cover:

1. Press the cover latches down on both sides of the middle chassis cover.
2. Lift the chassis cover to completely remove it from the chassis.

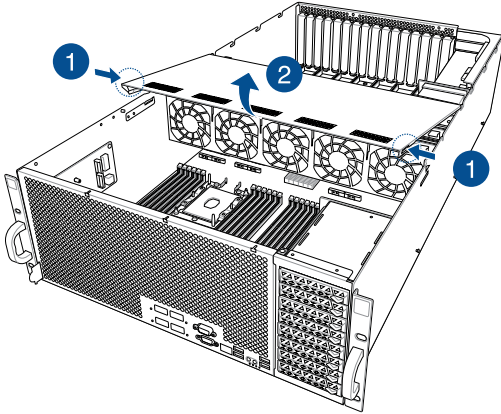

To remove the front chassis cover:

1. Push and hold the cover buttons down.
2. Slide the chassis cover towards the front to disengage it from the chassis and lift the chassis cover to completely remove it from the chassis.

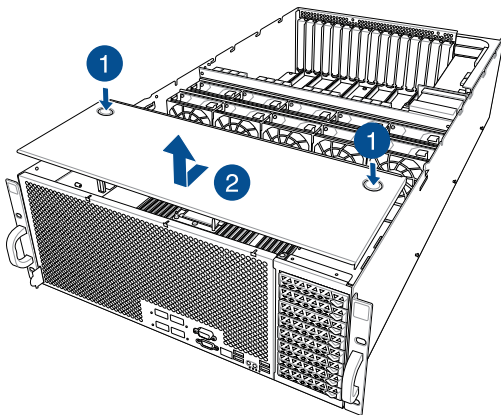

A protection film is pre-attached to the system cover before shipping. Please remove the protection film before turning on the system for proper heat dissipation.

2.1.1 Air duct



The diagrams in this section are for reference only. The system layout may vary with models, but the installation steps are the same for all models.

To remove the air ducts:

1. Remove the four (4) screws.

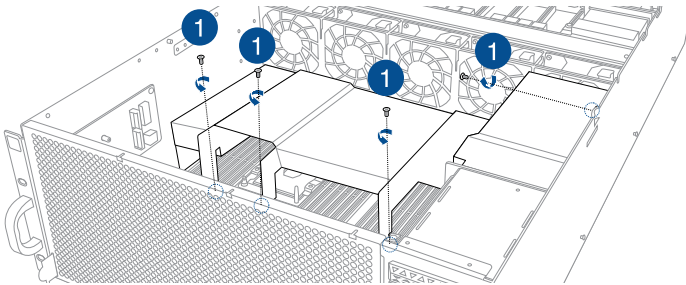

2. Lift the top air duct to remove it from the chassis.
3. Lift the bottom air duct to remove it from the motherboard.

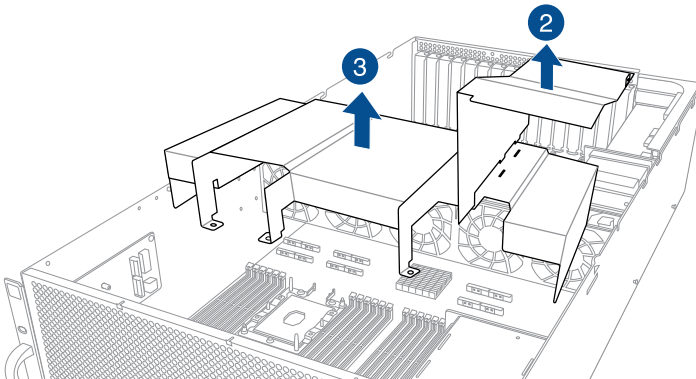

To reinstall the air duct:

1. Align and insert the tabs on the bottom air duct under the GPU fans.

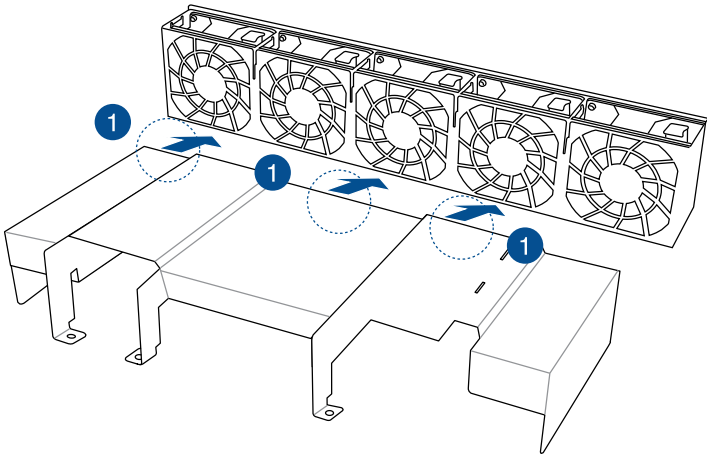

2. Align and reinstall the top and bottom air ducts into the chassis, ensuring that the screw holes on the air ducts match the screw holes on chassis.
3. Secure the air ducts to the chassis with the four (4) screws removed earlier.

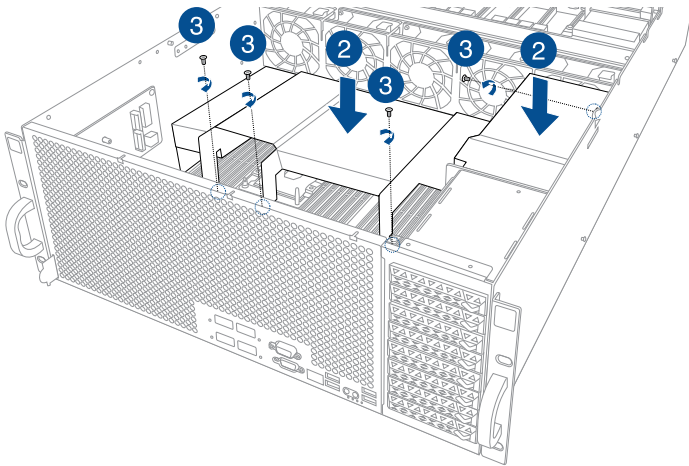

2.2 Central Processing Unit (CPU)

The motherboard comes with a surface mount LGA 3647 socket designed for the Intel® Xeon® Processor Scalable Family Series.



- Ensure that all power cables are unplugged before installing the CPU.
- Upon purchase of the server system, ensure that the PnP cap is on the socket and the socket contacts are not bent. Contact your retailer immediately if the PnP cap is missing, or if you see any damage to the PnP cap/socket contacts/motherboard components. ASUS will shoulder the cost of repair only if the damage is shipment/transit-related.
- The product warranty does not cover damage to the socket contacts resulting from incorrect CPU installation/removal, or misplacement/loss/incorrect removal of the PnP cap.

2.2.1 Installing the CPU and cooler

To install a CPU:

1. Remove the front chassis cover. For more information, see the section **Chassis cover**.
2. Remove the air duct. For more information, see the section **Air Duct**.
3. Remove the PnP caps from the CPU sockets.



Keep the PnP cap. ASUS will process Return Merchandise Authorization (RMA) requests only if the motherboard comes with the PnP cap on the LGA 3647 socket.

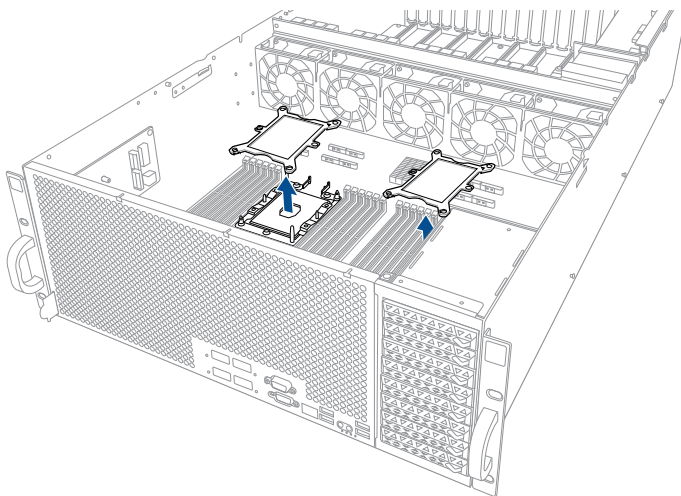

- Align the triangle mark on the CPU with the triangle mark on the CPU Carrier (A), install the CPU into the CPU Carrier until it clicks firmly into place (B), and then install the CPU and CPU Carrier into the cooler until it clicks firmly in place (C).



Ensure that the triangle mark on the CPU matches the triangle mark on the CPU Carrier.

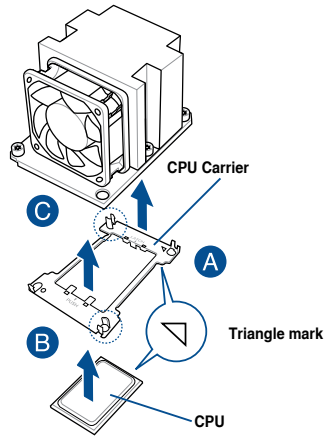

- Align the coolers in the correct orientation, then place the coolers on top of the CPU sockets.



The CPU and CPU Carrier fits in only one correct orientation. DO NOT force the CPU and CPU Carrier into the socket to prevent damaging the CPU pins on the socket.

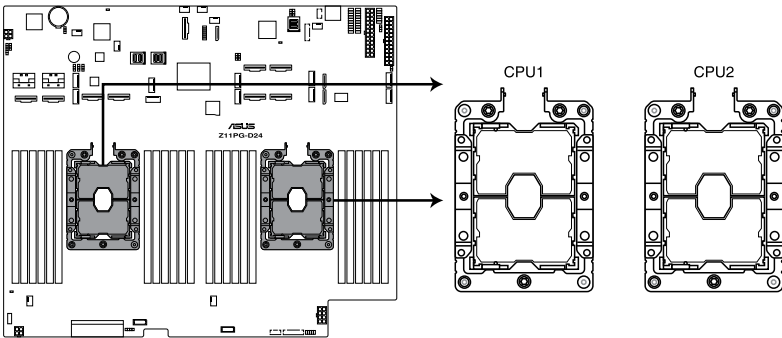

Z11PG-D24 CPU LGA3647 Socket

- Twist each of the four (4) screws with a screwdriver just enough to attach the cooler to the motherboard. When the four (4) screws are attached, tighten them one by one in a diagonal sequence to completely secure the cooler.



The cooler screws are T30 models. A torque value of 12 inch-lbf is recommended.

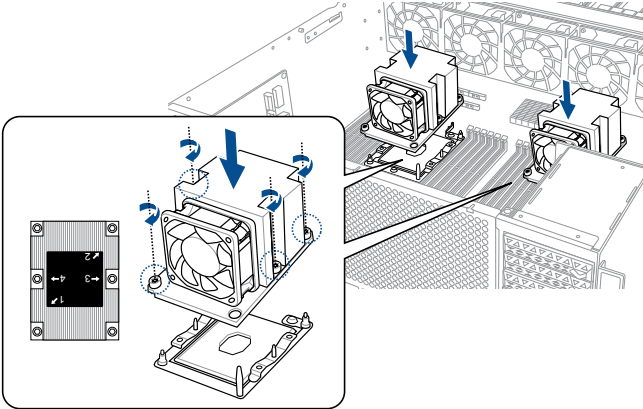

- Connect the FAN cable from the cooler to the CPU_FRNTFAN1 (CPU_FRNTFAN2 for the second cooler) connector on the motherboard.

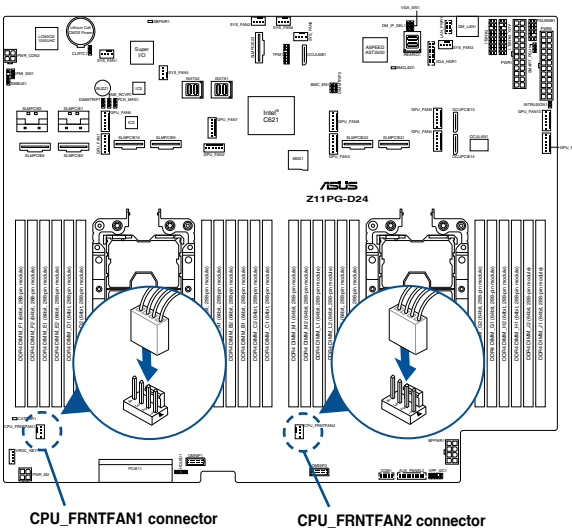

- Reinstall the air duct. For more information, see the section **Air Duct**.

2.3 System memory

2.3.1 Overview

The motherboard comes with 24 Double Data Rate 4 (DDR4) Dual Inline Memory Modules (DIMM) sockets.

The figure illustrates the location of the DDR4 DIMM sockets:

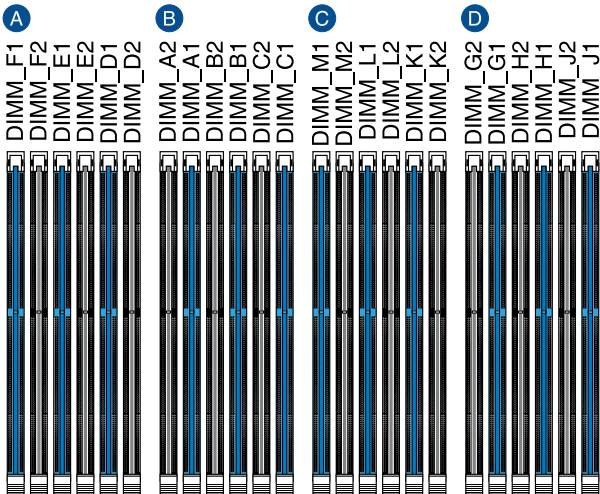
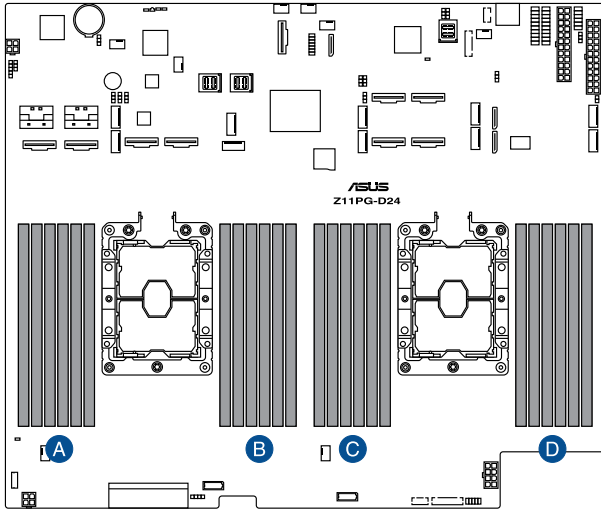

2.3.2 Memory Configurations

You may install 4GB, 8GB, 12GB, and 32GB RDIMMs; 64GB and 128GB RDIMMs (3DS); 32GB, 64GB, and 128GB LRDIMMs; 64GB, 128GB, and 256GB LRDIMMs (3DS); and 128GB, 256GB, and 512GB DCPMMs into the DIMM sockets using the memory configurations in this section.



- Refer to ASUS Server AVL for the updated list of compatible DIMMs.
- Always install DIMMs with the same CAS latency. For optimum compatibility, it is recommended that you obtain memory modules from the same vendor.

Recommended memory configuration for 1 CPU Configuration

1 CPU Configuration (must be on CPU1)						
	DIMM_A2	DIMM_A1	DIMM_B2	DIMM_B1	DIMM_C2	DIMM_C1
1 DIMM		•				
2 DIMMs		•				
4 DIMMs		•		•		
6 DIMMs		•		•		•
8 DIMMs	•	•	•	•		
12 DIMMs	•	•	•	•	•	•

1 CPU Configuration (must be on CPU1)						
	DIMM_D2	DIMM_D1	DIMM_E2	DIMM_E1	DIMM_F2	DIMM_F1
1 DIMM						
2 DIMMs		•				
4 DIMMs		•		•		
6 DIMMs		•		•		•
8 DIMMs	•	•	•	•		
12 DIMMs	•	•	•	•	•	•

Recommended memory configuration for 2 CPU Configuration

2 CPU Configuration						
	DIMM_A2	DIMM_A1	DIMM_B2	DIMM_B1	DIMM_C2	DIMM_C1
2 DIMMs		•				
4 DIMMs		•				
8 DIMMs		•		•		
12 DIMMs		•		•		•
16 DIMMs	•	•	•	•		
20 DIMMs	•	•	•	•		•
24 DIMMs	•	•	•	•	•	•

2 CPU Configuration						
	DIMM_D2	DIMM_D1	DIMM_E2	DIMM_E1	DIMM_F2	DIMM_F1
2 DIMMs						
4 DIMMs		•				
8 DIMMs		•		•		
12 DIMMs		•		•		•
16 DIMMs	•	•	•	•		
20 DIMMs	•	•	•	•		•
24 DIMMs	•	•	•	•	•	•

2 CPU Configuration						
	DIMM_G2	DIMM_G1	DIMM_H2	DIMM_H1	DIMM_J2	DIMM_J1
2 DIMMs		•				
4 DIMMs		•				
8 DIMMs		•		•		
12 DIMMs		•		•		•
16 DIMMs	•	•	•	•		
20 DIMMs	•	•	•	•		•
24 DIMMs	•	•	•	•	•	•

2 CPU Configuration						
	DIMM_K2	DIMM_K1	DIMM_L2	DIMM_L1	DIMM_M2	DIMM_M1
2 DIMMs						
4 DIMMs		•				
8 DIMMs		•		•		
12 DIMMs		•		•		•
16 DIMMs	•	•	•	•		
20 DIMMs	•	•	•	•		•
24 DIMMs	•	•	•	•	•	•

Intel® DC persistent memory population table

1 CPU Configuration

1 CPU Configuration (must be on CPU1)						
Modes	DIMM_F2	DIMM_F1	DIMM_E2	DIMM_E1	DIMM_D2	DIMM_D1
AD	DCPMM	DRAM 1	DCPMM	DRAM 1	DCPMM	DRAM 1
MM	DCPMM	DRAM 1	DCPMM	DRAM 1	DCPMM	DRAM 1
AD+MM	DCPMM	DRAM 3	DCPMM	DRAM 3	DCPMM	DRAM 3
AD		DRAM 1		DRAM 1	DCPMM	DRAM 1
MM		DRAM 2		DRAM 2	DCPMM	DRAM 2
AD+MM		DRAM 3		DRAM 3	DCPMM	DRAM 3
AD		DRAM 1	DCPMM	DRAM 1	DCPMM	DRAM 1
MM		DRAM 1	DCPMM	DRAM 1	DCPMM	DRAM 1
AD+MM		DRAM 3	DCPMM	DRAM 3	DCPMM	DRAM 3
AD		DCPMM		DRAM 1		DRAM 1
MM		DCPMM		DRAM 1		DRAM 1
AD+MM		DCPMM		DRAM 3		DRAM 3
AD		DCPMM	DRAM 1	DRAM 1	DRAM 1	DRAM 1

1 CPU Configuration (must be on CPU1)						
Modes	DIMM_C2	DIMM_C1	DIMM_B2	DIMM_B1	DIMM_A2	DIMM_A1
AD	DCPMM	DRAM 1	DCPMM	DRAM 1	DCPMM	DRAM 1
MM	DCPMM	DRAM 1	DCPMM	DRAM 1	DCPMM	DRAM 1
AD+MM	DCPMM	DRAM 3	DCPMM	DRAM 3	DCPMM	DRAM 3
AD		DRAM 1		DRAM 1	DCPMM	DRAM 1
MM		DRAM 2		DRAM 2	DCPMM	DRAM 2
AD+MM		DRAM 3		DRAM 3	DCPMM	DRAM 3
AD		DRAM 1	DCPMM	DRAM 1	DCPMM	DRAM1
MM		DRAM 1	DCPMM	DRAM 1	DCPMM	DRAM1
AD+MM		DRAM 3	DCPMM	DRAM 3	DCPMM	DRAM3
AD		DCPMM		DRAM 1		DRAM1
MM		DCPMM		DRAM 1		DRAM1
AD+MM		DCPMM		DRAM 3		DRAM3
AD		DCPMM	DRAM 1	DRAM 1	DRAM 1	DRAM1

AD - APP DIRECT MODE

MM - MEMORY MODE

AD+MM - MIXED MODE

DRAM1 - RDIMM, RDIMM 3DS, LRDIMM, LRDIMM 3DS

DRAM2 - RDIMM only

DRAM3 - RDIMM, RDIMM 3DS, LRDIMM

DCPMM - DC PERSISTENT MEMORY

2 CPU Configuration (symmetric population)

2 CPU Configuration (symmetric population)						
Modes	DIMM_F2	DIMM_F1	DIMM_E2	DIMM_E1	DIMM_D2	DIMM_D1
AD	DCPMM	DRAM 1	DCPMM	DRAM 1	DCPMM	DRAM 1
MM	DCPMM	DRAM 1	DCPMM	DRAM 1	DCPMM	DRAM 1
AD+MM	DCPMM	DRAM 3	DCPMM	DRAM 3	DCPMM	DRAM 3
AD		DRAM 1		DRAM 1	DCPMM	DRAM 1
MM		DRAM 2		DRAM 2	DCPMM	DRAM 2
AD+MM		DRAM 3		DRAM 3	DCPMM	DRAM 3
AD		DRAM 1	DCPMM	DRAM 1	DCPMM	DRAM 1
MM		DRAM 1	DCPMM	DRAM 1	DCPMM	DRAM 1
AD+MM		DRAM 3	DCPMM	DRAM 3	DCPMM	DRAM 3
AD		DCPMM		DRAM 1		DRAM 1
MM		DCPMM		DRAM 1		DRAM 1
AD+MM		DCPMM		DRAM 3		DRAM 3
AD		DCPMM	DRAM 1	DRAM 1	DRAM 1	DRAM 1

2 CPU Configuration (symmetric population)						
Modes	DIMM_C2	DIMM_C1	DIMM_B2	DIMM_B1	DIMM_A2	DIMM_A1
AD	DCPMM	DRAM 1	DCPMM	DRAM 1	DCPMM	DRAM 1
MM	DCPMM	DRAM 1	DCPMM	DRAM 1	DCPMM	DRAM 1
AD+MM	DCPMM	DRAM 3	DCPMM	DRAM 3	DCPMM	DRAM 3
AD		DRAM 1		DRAM 1	DCPMM	DRAM 1
MM		DRAM 2		DRAM 2	DCPMM	DRAM 2
AD+MM		DRAM 3		DRAM 3	DCPMM	DRAM 3
AD		DRAM 1	DCPMM	DRAM 1	DCPMM	DRAM1
MM		DRAM 1	DCPMM	DRAM 1	DCPMM	DRAM1
AD+MM		DRAM 3	DCPMM	DRAM 3	DCPMM	DRAM3
AD		DCPMM		DRAM 1		DRAM1
MM		DCPMM		DRAM 1		DRAM1
AD+MM		DCPMM		DRAM 3		DRAM3
AD		DCPMM	DRAM 1	DRAM 1	DRAM 1	DRAM1

(continued on the next page)

2 CPU Configuration (symmetric population)						
Modes	DIMM_M2	DIMM_M1	DIMM_L2	DIMM_L1	DIMM_K2	DIMM_K1
AD	DCPMM	DRAM 1	DCPMM	DRAM 1	DCPMM	DRAM 1
MM	DCPMM	DRAM 1	DCPMM	DRAM 1	DCPMM	DRAM 1
AD+MM	DCPMM	DRAM 3	DCPMM	DRAM 3	DCPMM	DRAM 3
AD		DRAM 1		DRAM 1	DCPMM	DRAM 1
MM		DRAM 2		DRAM 2	DCPMM	DRAM 2
AD+MM		DRAM 3		DRAM 3	DCPMM	DRAM 3
AD		DRAM 1	DCPMM	DRAM 1	DCPMM	DRAM 1
MM		DRAM 1	DCPMM	DRAM 1	DCPMM	DRAM 1
AD+MM		DRAM 3	DCPMM	DRAM 3	DCPMM	DRAM 3
AD		DCPMM		DRAM 1		DRAM 1
MM		DCPMM		DRAM 1		DRAM 1
AD+MM		DCPMM		DRAM 3		DRAM 3
AD		DCPMM	DRAM 1	DRAM 1	DRAM 1	DRAM 1

2 CPU Configuration (symmetric population)						
Modes	DIMM_J2	DIMM_J1	DIMM_H2	DIMM_H1	DIMM_G2	DIMM_G1
AD	DCPMM	DRAM 1	DCPMM	DRAM 1	DCPMM	DRAM 1
MM	DCPMM	DRAM 1	DCPMM	DRAM 1	DCPMM	DRAM 1
AD+MM	DCPMM	DRAM 3	DCPMM	DRAM 3	DCPMM	DRAM 3
AD		DRAM 1		DRAM 1	DCPMM	DRAM 1
MM		DRAM 2		DRAM 2	DCPMM	DRAM 2
AD+MM		DRAM 3		DRAM 3	DCPMM	DRAM 3
AD		DRAM 1	DCPMM	DRAM 1	DCPMM	DRAM1
MM		DRAM 1	DCPMM	DRAM 1	DCPMM	DRAM1
AD+MM		DRAM 3	DCPMM	DRAM 3	DCPMM	DRAM3
AD		DCPMM		DRAM 1		DRAM1
MM		DCPMM		DRAM 1		DRAM1
AD+MM		DCPMM		DRAM 3		DRAM3
AD		DCPMM	DRAM 1	DRAM 1	DRAM 1	DRAM1

AD - APP DIRECT MODE

MM - MEMORY MODE

AD+MM - MIXED MODE

DRAM1 - RDIMM, RDIMM 3DS, LRDIMM, LRDIMM 3DS

DRAM2 - RDIMM only

DRAM3 - RDIMM, RDIMM 3DS, LRDIMM

DCPMM - DC PERSISTENT MEMORY

1 CPU Configuration with 1 DCPMM DIMM (asymmetric population)

Asymmetric Population (2nd Socket has no DCPMM DIMM)						
Modes	DIMM_F2	DIMM_F1	DIMM_E2	DIMM_E1	DIMM_D2	DIMM_D1
AD		DRAM 1		DRAM 1		DRAM 1

Asymmetric Population (2nd Socket has no DCPMM DIMM)						
Modes	DIMM_C2	DIMM_C1	DIMM_B2	DIMM_B1	DIMM_A2	DIMM_A1
AD		DRAM 1		DRAM 1	DCPMM	DRAM 1

AD - APP DIRECT MODE

DRAM1 - RDIMM, RDIMM 3DS, LRDIMM, LRDIMM 3DS

DCPMM - DC PERSISTENT MEMORY

2 CPU Configuration with 1 DCPMM DIMM (asymmetric population)

Asymmetric Population (2nd Socket has no DCPMM DIMM)						
Modes	DIMM_F2	DIMM_F1	DIMM_E2	DIMM_E1	DIMM_D2	DIMM_D1
AD		DRAM 1		DRAM 1		DRAM 1

Asymmetric Population (2nd Socket has no DCPMM DIMM)						
Modes	DIMM_C2	DIMM_C1	DIMM_B2	DIMM_B1	DIMM_A2	DIMM_A1
AD		DRAM 1		DRAM 1	DCPMM	DRAM 1

Asymmetric Population (2nd Socket has no DCPMM DIMM)						
Modes	DIMM_M2	DIMM_M1	DIMM_L2	DIMM_L1	DIMM_K2	DIMM_K1
AD		DRAM 1		DRAM 1		DRAM 1

Asymmetric Population (2nd Socket has no DCPMM DIMM)						
Modes	DIMM_J2	DIMM_J1	DIMM_H2	DIMM_H1	DIMM_G2	DIMM_G1
AD		DRAM 1		DRAM 1		DRAM 1

AD - APP DIRECT MODE

DRAM1 - RDIMM, RDIMM 3DS, LRDIMM, LRDIMM 3DS

DCPMM - DC PERSISTENT MEMORY

2 CPU Configuration with 2 DCPMM DIMMs (asymmetric population)

2 CPU Configuration (asymmetric population)						
Modes	DIMM_F2	DIMM_F1	DIMM_E2	DIMM_E1	DIMM_D2	DIMM_D1
AD		DRAM 1		DRAM 1		DRAM 1

2 CPU Configuration (asymmetric population)						
Modes	DIMM_C2	DIMM_C1	DIMM_B2	DIMM_B1	DIMM_A2	DIMM_A1
AD		DRAM 1		DRAM 1	DCPMM	DRAM 1

2 CPU Configuration (asymmetric population)						
Modes	DIMM_M2	DIMM_M1	DIMM_L2	DIMM_L1	DIMM_K2	DIMM_K1
AD		DRAM 1		DRAM 1		DRAM 1

2 CPU Configuration (asymmetric population)						
Modes	DIMM_J2	DIMM_J1	DIMM_H2	DIMM_H1	DIMM_G2	DIMM_G1
AD		DRAM 1		DRAM 1	DCPMM	DRAM 1

AD - APP DIRECT MODE

DRAM1 - RDIMM, RDIMM 3DS, LRDIMM, LRDIMM 3DS

DCPMM - DC PERSISTENT MEMORY

2.3.3 Installing a DIMM on a single clip DIMM socket



Ensure to unplug the power supply before adding or removing DIMMs or other system components. Failure to do so may cause severe damage to both the motherboard and the components.

1. Unlock a DIMM socket by pressing the retaining clip outward.
2. Align a DIMM on the socket such that the notch on the DIMM matches the DIMM slot key on the socket.

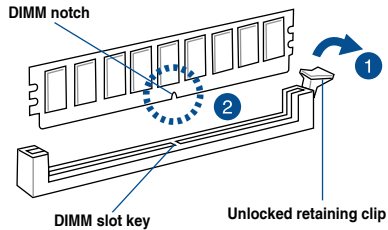

A DIMM is keyed with a notch so that it fits in only one direction. **DO NOT** force a DIMM into a socket in the wrong direction to avoid damaging the DIMM.

3. Hold the DIMM by both of its ends then insert the DIMM vertically into the socket. Apply force to both ends of the DIMM simultaneously until the retaining clip snaps back into place and the DIMM cannot be pushed in any further to ensure proper sitting of the DIMM.

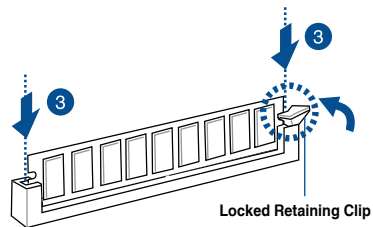

Always insert the DIMM into the socket vertically to prevent DIMM notch damage.

2.3.4 Removing a DIMM from a single clip DIMM socket

1. Press the retaining clip outward to unlock the DIMM.
2. Remove the DIMM from the socket.

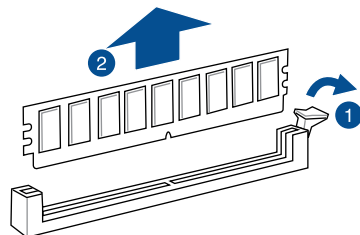

Support the DIMM lightly with your fingers when pressing the retaining clips. The DIMM might get damaged when it flips out with extra force.

2.4 Storage devices

The ESC8000 G4 Series system supports hot-swap 2.5-inch SATA/SAS storage devices. The storage device installed in the storage bay connects to the motherboard SATA/SAS ports via the SATA/SAS backplane.

2.4.1 Installing 2.5-inch SATA HDD/SAS storage devices

To install a 2.5-inch storage device:

1. Press the spring lock.

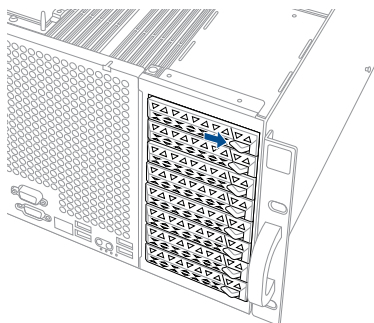

2. Pull the tray lever outwards to remove the storage device tray.

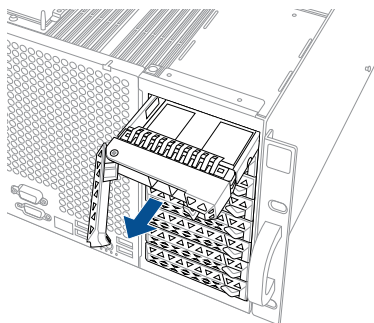

3. Place the storage device tray on a flat and stable surface.
4. Release the screws on each side of the storage device tray to release the metal beam.

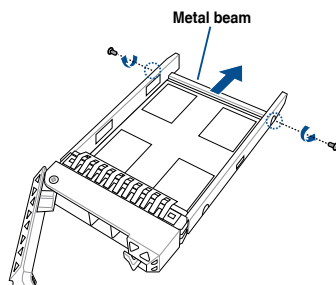

The metal beam supports the storage device tray horizontally to prevent the storage device tray from bending or deforming.

5. Place the SATA/SAS storage device into the storage device tray then secure it with four (4) screws.

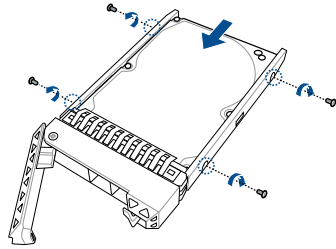

6. Insert the storage device tray and storage device assembly all the way into the depth of the bay until just a small fraction of the tray edge protrudes.
7. Push the tray lever until it clicks and secures the storage device tray in place.
8. Repeat steps 1 to 7 to install the other storage devices.

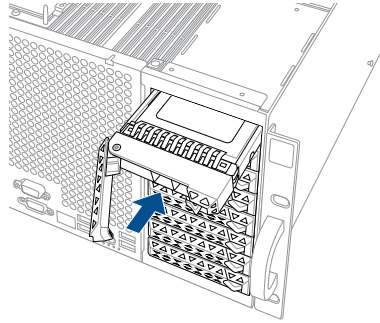

2.5 Expansion slots



Ensure to unplug the power cord before adding or removing expansion cards. Failure to do so may cause you physical injury and damage motherboard components.

2.5.1 The PCI Express riser card

The server system comes pre-installed with a riser card that supports two x16 slots (Gen3 x16 link) for installing PCI-E x16 low profile of half-length cards.

To install PCI-E expansion cards to the riser card:

1. Remove the two (2) screws that secure the riser card to the chassis.

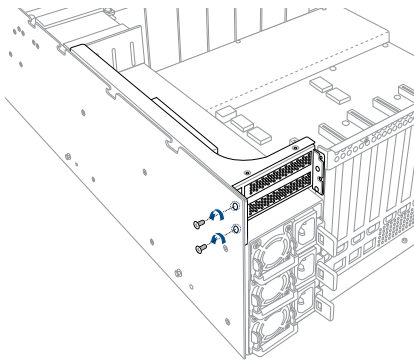

2. Firmly hold the riser card, slide the riser card towards the front of the chassis to unlock it, then pull it up to detach it from the chassis.

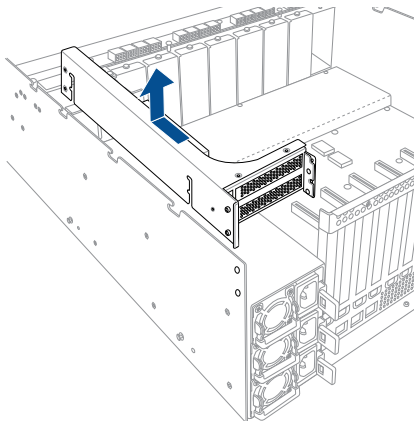

3. Remove the screw from the metal bracket on the riser card (A), then remove the metal bracket from the riser card (B).

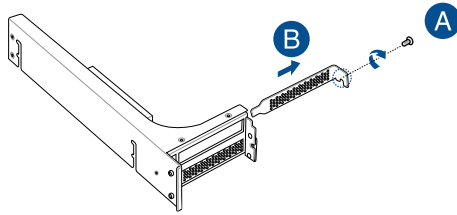

4. Prepare the expansion card.



Before installing an expansion card, read the documentation that came with it and ensure to make the necessary hardware settings.

5. Align and insert the expansion card into the PCI-E slot connector on the riser card, then secure the expansion card with the screw removed earlier.

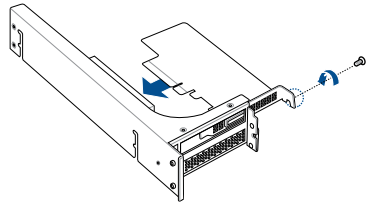

6. Align and insert the riser card and expansion card assembly into the chassis, then slide the riser card and expansion card assembly towards the rear of the chassis to lock it in place.

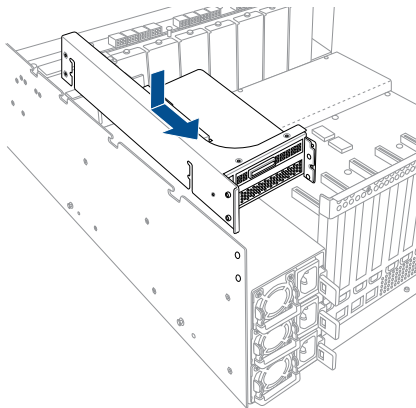

7. Secure the riser card and expansion card assembly with the two (2) screws that you removed earlier in step 1.

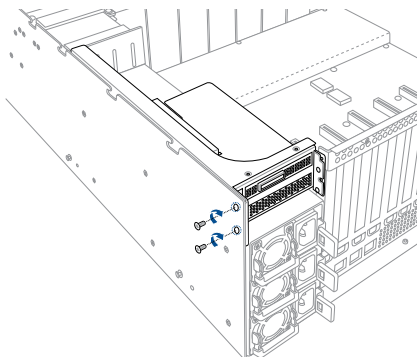

2.5.2 Installing an ASUS PIKE II card

1. Remove the two (2) screws on the ASUS PIKE II card bracket (A), then remove the ASUS PIKE II card bracket (B) from the chassis.

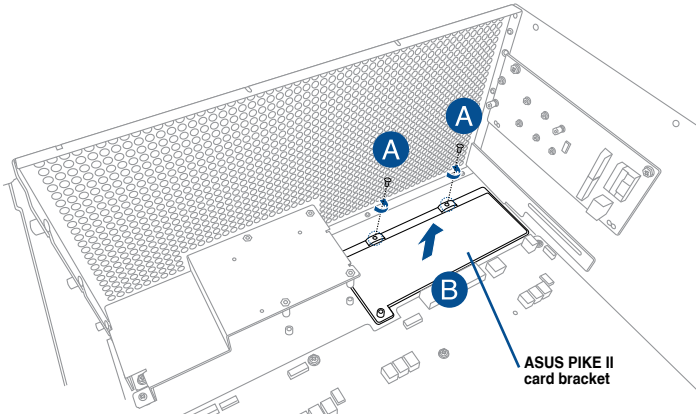

2. Prepare the ASUS PIKE II card.
3. Align the two (2) screw washers to the two screw holes on the ASUS PIKE II card (A), then secure the bundled screws to the screw washers from the bottom of the ASUS PIKE II card (B).

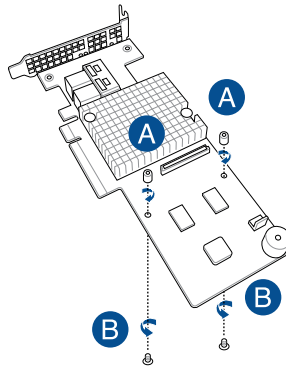

4. Align and install the Cache Vault Flash Module to the connector on the ASUS PIKE II card (A), then secure the Cache Vault Flash Module to the screw washers with the bundled screws (B).

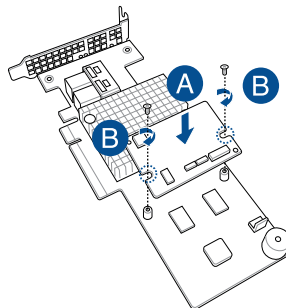

5. Remove the two (2) screws on the ASUS PIKE II card (A), then remove the card bracket (B).

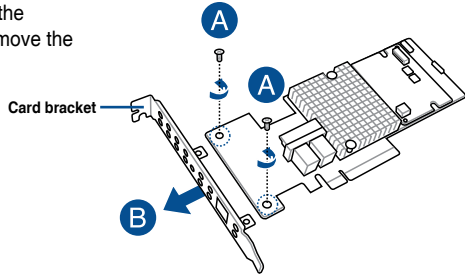

6. Secure the ASUS PIKE II card to the ASUS PIKE II card bracket with the two (2) screws that you removed earlier.

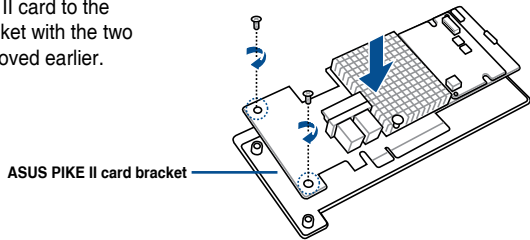

7. Connect the mini-SAS HD cables to the ASUS PIKE II card (A), insert the ASUS PIKE II card and the ASUS PIKE II card bracket into the PCI-E slot on the motherboard (B), then secure it with the two (2) screws that you removed earlier (C).

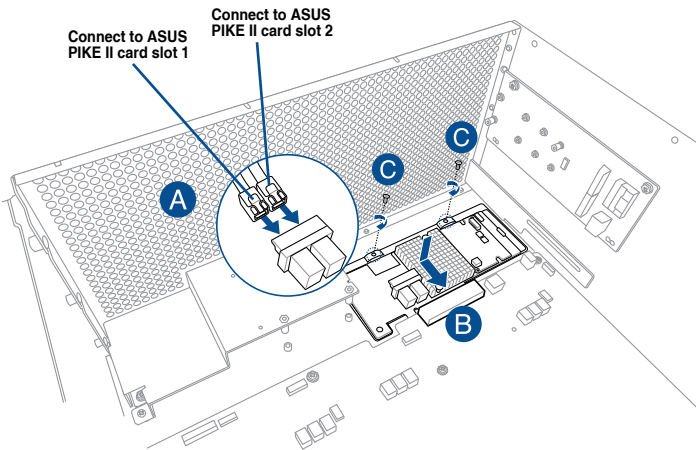

8. Remove the default cable from the backplane (A), then connect the other end of the mini-SAS HD cables from the ASUS PIKE II card to the SATA/SAS backplane.

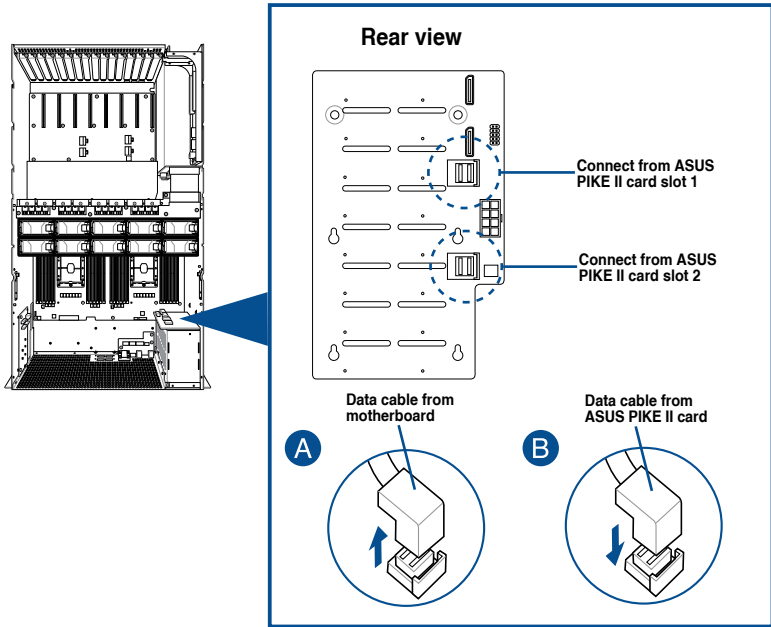

9. Remove the two (2) screws securing the Cache Vault bracket (A), then remove the Cache Vault bracket from the chassis (B).

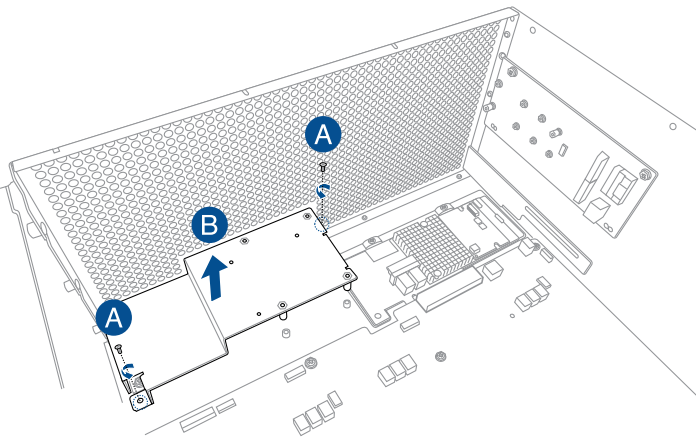

10. Align the three screw holes on the Cache Vault Power Module clip to the three screw holes on the Cache Vault bracket, then secure the clip with the bundled three (3) screws and three (3) bundled nuts.

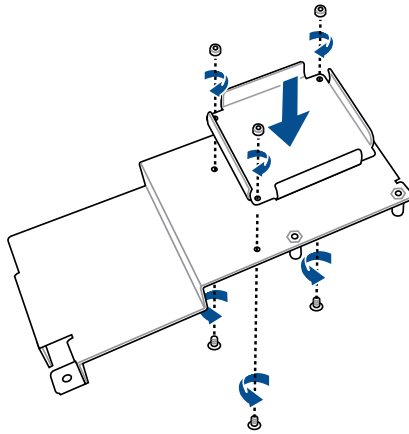

11. Align and install the Cache Vault Power Module into the Cache Vault Power Module clip.

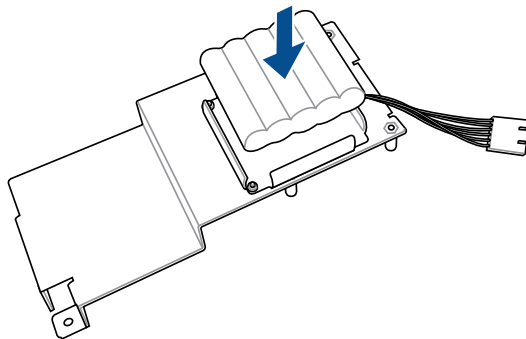

12. Install the Cache Vault bracket and Cache Vault Power Module assembly into the chassis (A), then secure it with the two (2) screws removed earlier (B).

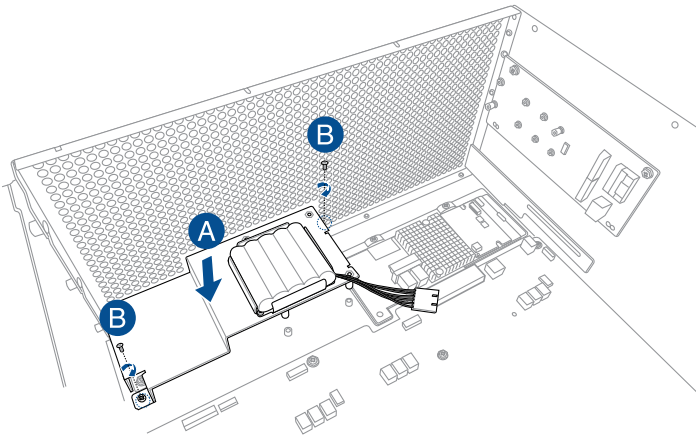

13. Connect the cable extender to the Cache Vault Flash Module (A), then connect the cable to the Cache Vault Power Module (B) to complete.

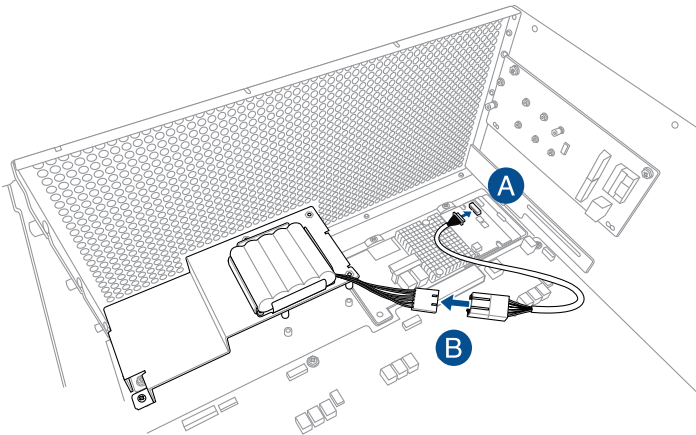

2.5.3 Installing an M.2 expansion card

You can install an M.2 expansion card on the provided M.2 slot onboard (supports up to 22110).

To install an M.2 expansion card:

1. Remove the screw on the M.2 socket and put it aside.

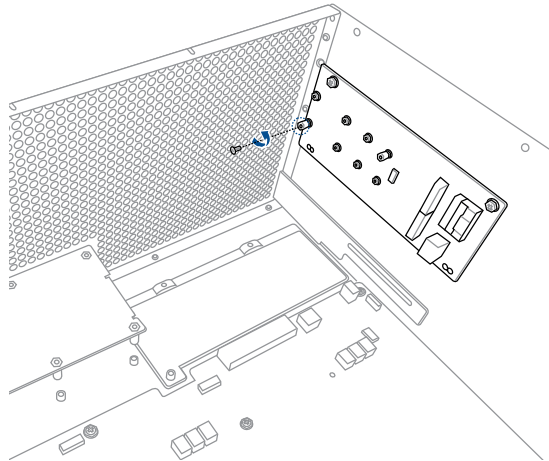

2. Prepare your M.2 expansion card.
3. Align and insert the M.2 card into the M.2 slot onboard as shown.

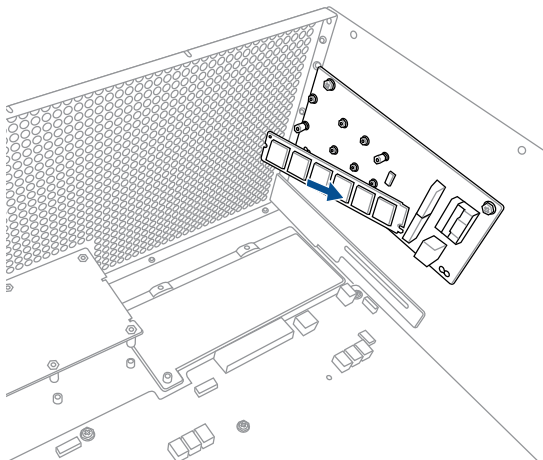

4. Secure the M.2 card with a screw to complete the installation.

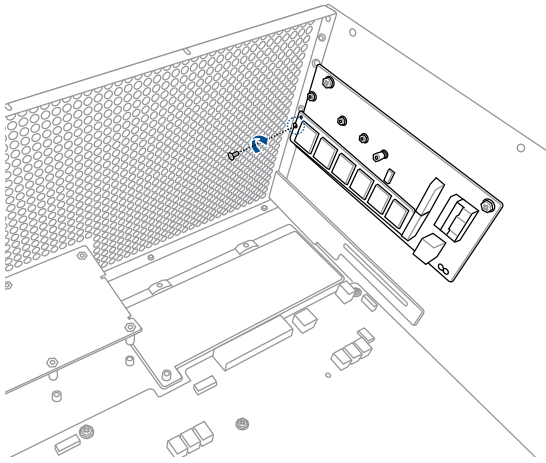

-
- Please pay attention when removing the screw, the stand screw might be removed together with it.
 - Ensure that the M.2 card is positioned between the screw and the stand screw before securing it.
-

2.6 Cable connections



- The bundled system cables are pre-connected before shipment. You do not need to disconnect these cables unless you remove the pre-installed components to install additional devices.
- Refer to Chapter 4 for detailed information on the motherboard connectors.

Motherboard

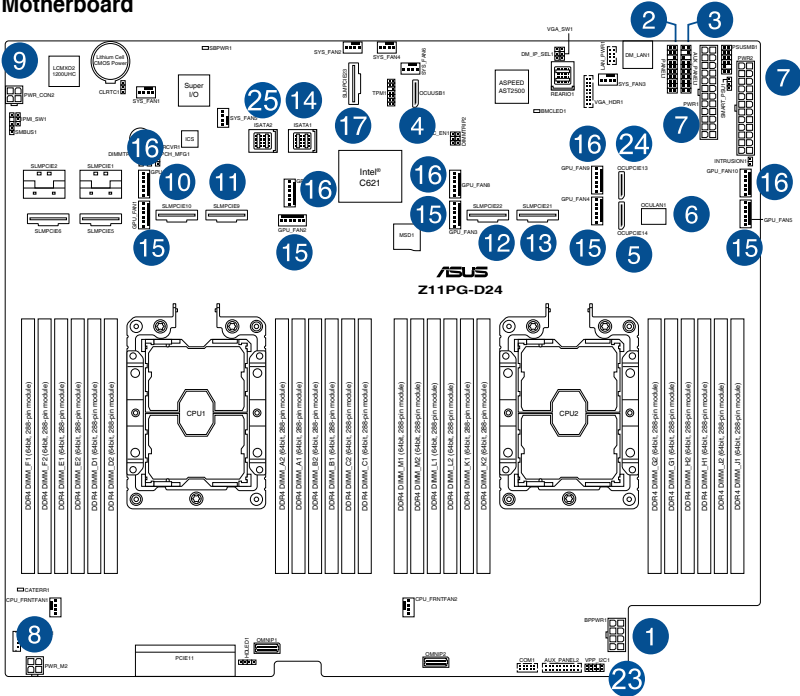

M.2 board

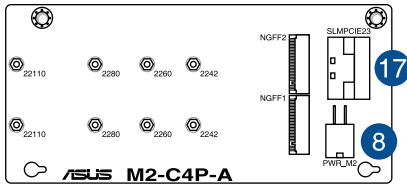

PCIe riser board

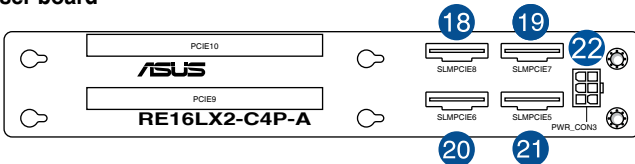

PCIe SKU board

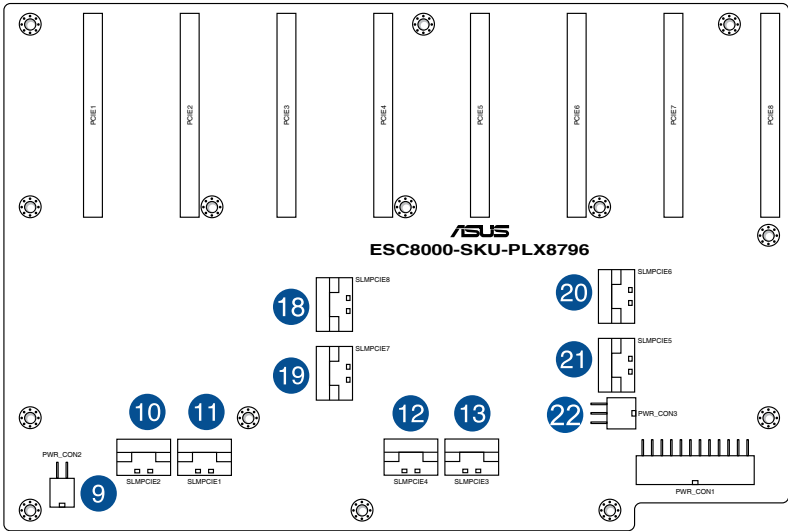

SATA/SAS backplane

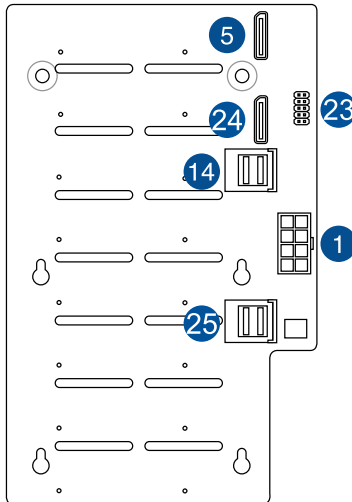

Pre-connected system cables

1. 8-pin BPPWR1 power connector (from motherboard to SATA/SAS backplane)
2. Panel connector (from motherboard to front I/O board)
3. Auxiliary panel 1 connector (from motherboard to front I/O board)
4. OCU-USB to USB connector (from motherboard to front I/O board)
5. OCU-PCIE to PCIE connector (from motherboard to SATA/SAS backplane)
6. OCU-LAN to LAN connector (from motherboard to rear I/O board)
7. 20-pin SSI power connectors (from power distribution board to motherboard)
8. 4-pin PWR_M2 power connector (from motherboard to M.2 board)
9. 4-pin PWR_CON2 power connector (from motherboard to PCIE SKU board)
10. SLMPCIE connector (from motherboard to PCIE SKU board)
11. SLMPCIE connector (from motherboard to PCIE SKU board)
12. SLMPCIE connector (from motherboard to PCIE SKU board)
13. SLMPCIE connector (from motherboard to PCIE SKU board)
14. ISATA connector (from motherboard to SATA/SAS backplane)
15. 1st row GPU fan connectors (from motherboard to GPU fans)
16. 2nd row GPU fan connectors (from motherboard to GPU fans)
17. SLMPCIE connector (from motherboard to M.2 board)
18. SLMPCIE connector (from PCIE SKU board to PCIE riser board)
19. SLMPCIE connector (from PCIE SKU board to PCIE riser board)
20. SLMPCIE connector (from PCIE SKU board to PCIE riser board)
21. SLMPCIE connector (from PCIE SKU board to PCIE riser board)
22. 6-pin PWR_CON3 power connector (from PCIE SKU board to PCIE riser board)
23. VPP_IC21 connector (from motherboard to SATA/SAS backplane)
24. OCU-PCIE to PCIE connector (from motherboard to SATA/SAS backplane)
25. ISATA connector (from motherboard to SATA/SAS backplane)

2.7 Removable/optional components

You may need to remove previously installed system components when installing or removing system devices. You may need to install the optional components into the system. This section tells how to remove/install the following components:

1. GPU fans
2. Redundant power supply units



Ensure that the system is turned off before removing any components.

2.7.1 GPU fans

To uninstall the GPU fans:

1. Press the latch inwards (A) to release the GPU fan, then lift the fan from the fan cage (B).
2. Set the fan aside.
3. Repeat steps 1 to 2 to uninstall the other GPU fans.

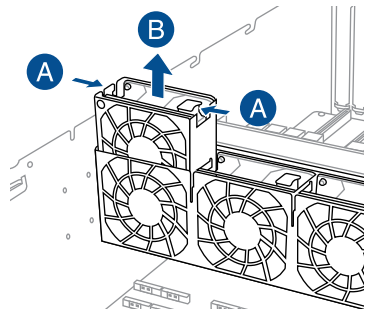

To reinstall the GPU fans, insert the fan into the fan cage. Ensure the fan connector is seated firmly within the cable holder.

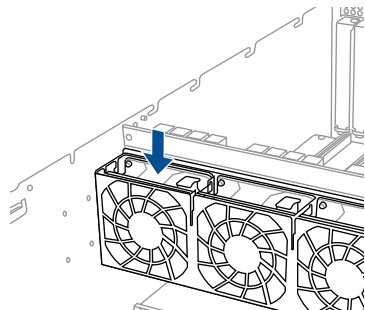

2.7.2 Redundant power supply units



We recommend that you use both of your hands in performing the following steps.

To replace a power supply unit (PSU):

1. Lift up the PSU lever.
2. Hold the PSU lever, press the PSU latch (A) then carefully pull the PSU out of the system chassis (B).

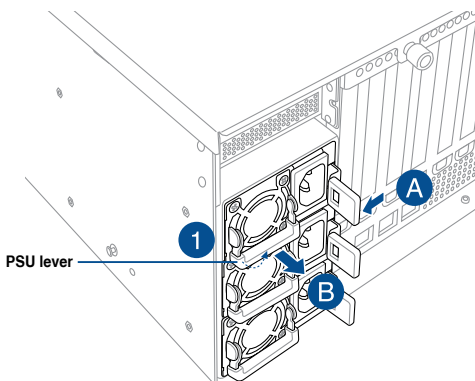

3. Prepare the replacement PSU.
4. Align and insert the replacement PSU into the empty PSU bay until it clicks in place.

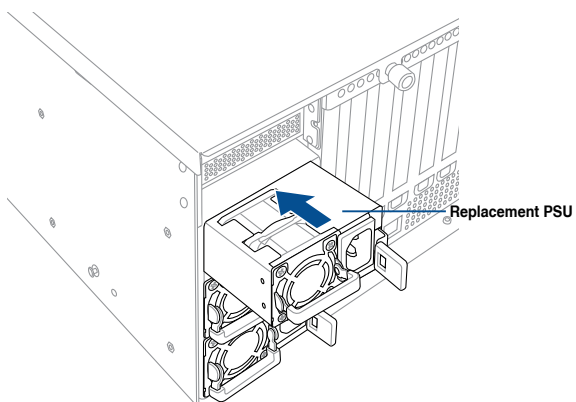



-
- The system automatically combines the two power supply modules as a single one. The combined output power varies with input voltages.
 - To enable the hot-swap feature (redundant mode), keep the total power consumption of the system under the maximum output power of an individual power supply module.
-



- Always use PSUs with the same watt and power rating. Combining PSUs with different wattage (e.g. 1 x 1620 W + 1 x 2000 W) may yield unstable results and potential damage to your system.
 - For a steady power input, use only the power cables that come with the server system package.
-

2.8 Installing GPU cards



- Use both of your hands in performing the following steps.
- Read the documentation that comes with your GPU card before installing them.
- When installing more than one GPU card, it is recommended to install the card on PCIe1 slot first.



- When the PCI-E topology is set to **Single Root**, the video output order will be PCIe5 > PCIe8 > PCIe6 > PCIe7 > PCIe1 > PCIe4 > PCIe2 > PCIe3.
- When the PCI-E topology is set to **Dual Root**, the video output order will be PCIe1 > PCIe4 > PCIe2 > PCIe3 > PCIe5 > PCIe8 > PCIe6 > PCIe7.

To install a GPU card to the system:

1. Remove the screws on the metal covers on the rear panel and the corresponding metal shutter at the middle of the server system (A), then remove the metal covers and the metal shutter from the chassis (B).

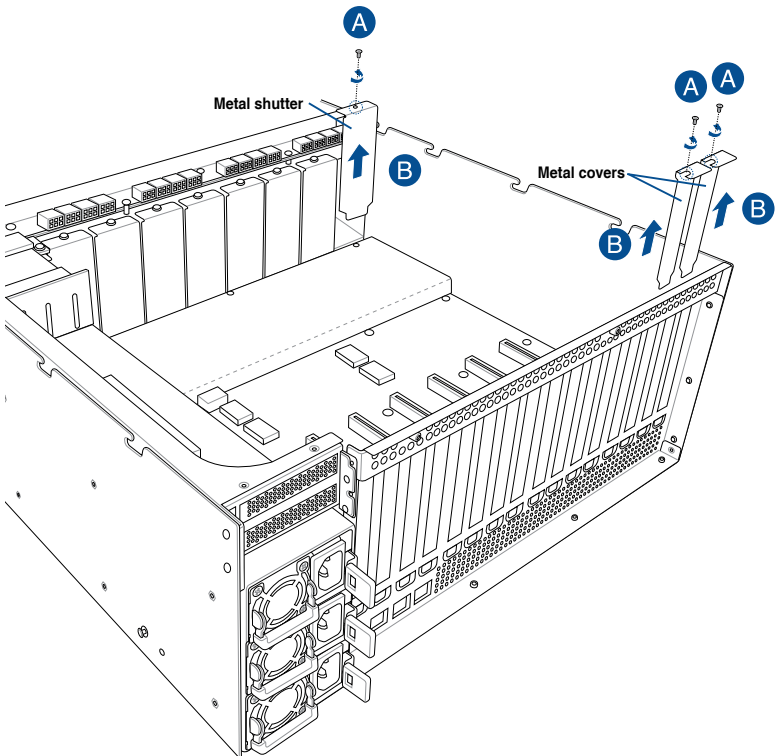

- (optional) For AMD® S9150 or later GPU cards, attach a mylar to the GPU air duct first before installing the air duct to the GPU card.

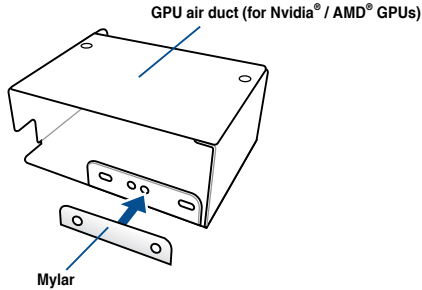

The mylar is bundled with the system and included in the accessory box.

- (optional) For Nvidia® CPU-12V or above GPU cards, prepare the GPU card dongle or power cable.

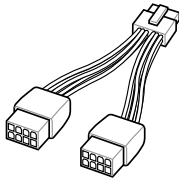

Nvidia CPU-12V GPU card dongle

OR

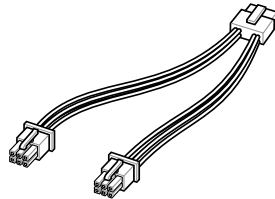

ASUS CPU 8-pin power cable

A dongle may be required to connect the system's GPU power cable to the GPU card. The Nvidia® CPU-12V GPU card will not work, or may even cause damage to the system, if the dongle is not used.

The ASUS CPU 8-pin power cable may be used to connect to the GPU card and 6-pin power connector.



The Nvidia® CPU-12V GPU card dongle comes with your Nvidia® CPU-12V GPU card. Ask your vendor or retailer if the dongle is missing.

4. Connect the GPU power cable, Nvidia® CPU-12V GPU card dongle, or ASUS CPU 8-pin power cable to the connector on the GPU card as shown.

Intel® / AMD® / Nvidia® GPU cards with power cable

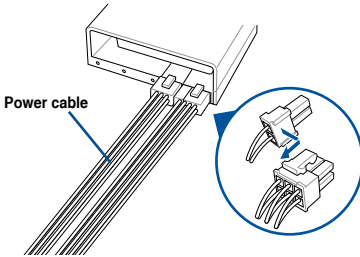

Nvidia® CPU-12V or above GPU cards with power cable and Nvidia® CPU-12V GPU card dongle

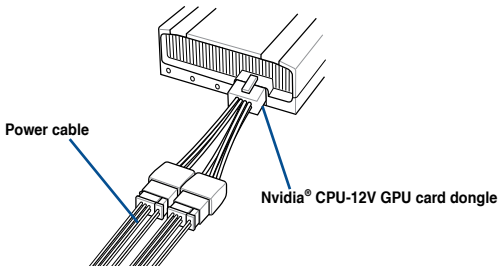

Nvidia® CPU-12V or above GPU cards with ASUS CPU 8-pin power cable

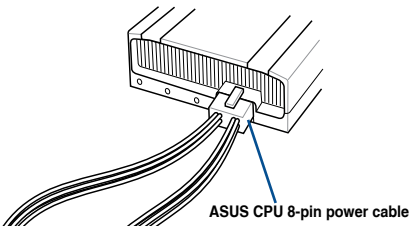

5. Align the air duct to the GPU card and pass the power cable (or power cable and dongle) through the notched area on the air duct.

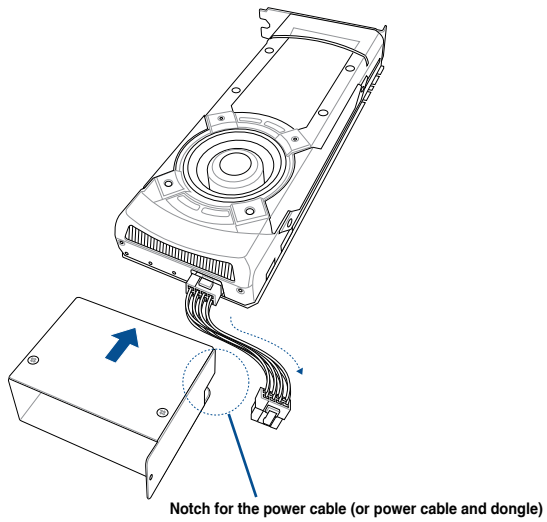

6. From inside the air duct, secure the air duct to the GPU card with two (2) screws.

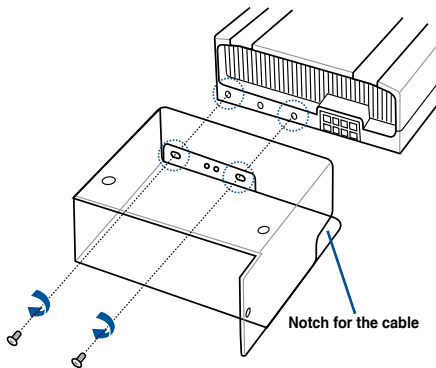

7. Attach the other end of the power cable (6-pin power connector) to an available 6-pin power connector on the middle of the server system (A), align and insert the golden fingers of the GPU card into the PCIe slot on the PCIe SKU board (B), then secure the GPU card with the two (2) screws that you removed earlier in step 1 (C).

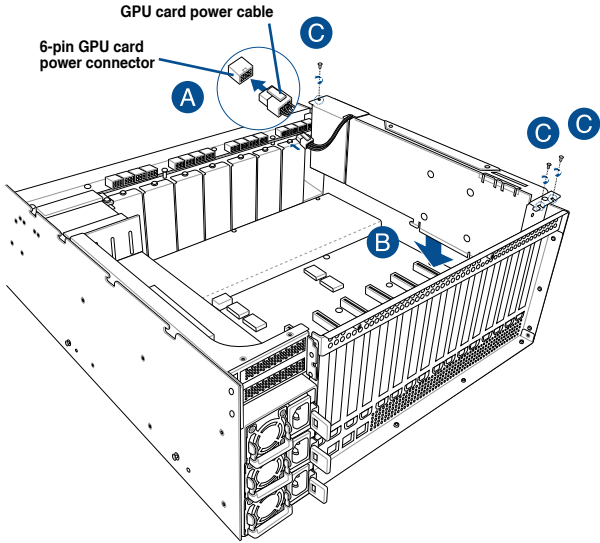

8. Repeat steps 1-7 if you need to install additional GPU cards.

Installation Options

3





This chapter describes how to install the optional components and devices into the barebone server.

3.1 Rail Kit

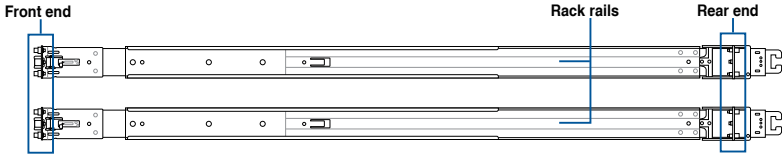
The rail kit package includes:

2 x 1200 mm rack rails (or 2 x 1000 mm rack rails)



-  4 x #6-32X4L screws
-  4 x M4X4L screws
-  8 x ø17.1 screws
-  8 x #10-32 screws (or 10 x #10-32 screws for 1000 mm rack rails)
-  2 x M5X20L screws



- The bundled screw package includes different types of screws for you to choose from, not all screws are required for the installation.
- Package content and specifications are subject to change without notice.

3.1.1 Selecting rack rail cabinets

Refer to the guide below for more information on selecting a rack rail cabinet and rack rail for your server system.

1200 mm rack rail with CMA

A = 700.3 mm (27.6") ~ 965.5 mm (38")
 A + B > 1125 mm (44.3")

1200 mm rack rail without CMA

A = 700.3 mm (27.6") ~ 965.5 mm (38")
 A + B > 1025 mm (40.4")

1000 mm rack rail without CMA

A = 685.7 mm (27") ~ 916.5 mm (36")
 A + B > 835 mm (32.9")

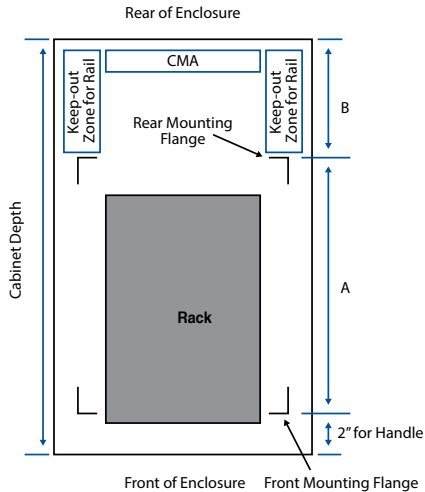

Even without a CMA, another 9" (for 1200 mm rack rails) or 2" (for 1000 mm rack rails) of additional keep-out zone should be reserved behind the inner rail. No obstructions such as power cables or sockets should be present in this keep-out zone.

3.1.2 Attaching the rack rails



- Ensure that the rack rail cabinet and the rack posts are stable and standing firmly on a level surface.
- We strongly recommend that at least two able-bodied persons perform the steps described in this guide.
- We recommend the use of an appropriate lifting tool or device, if necessary.



The installation steps in this section uses a **1200 mm rack rail** as an example, the installation steps for a **1000 mm rack rail** is exactly the same.

Installing the rack rail

To install the rack rails into the rack:

1. Select a desired space on the rack.



A 1U space consists of three square mounting holes with two thin lips on the top and the bottom.

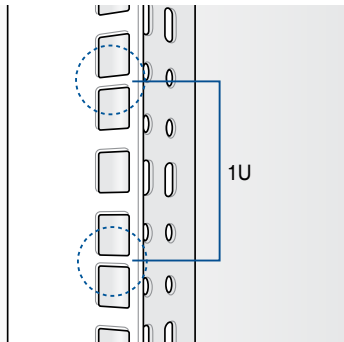

2. Align and insert the front end of the appropriate rack rail (left and right) into the front rack post.

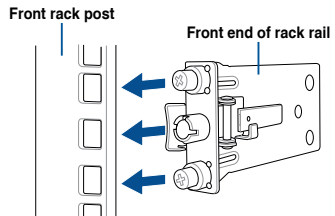

3. Press the spring lock on the rear end of the rack rail and insert the studs into the selected mounting holes on the rear rack post.

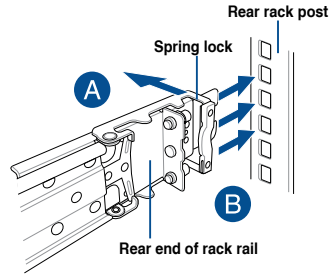

4. Slide the intermediate rail out of the outer rail until it clicks to a stop.

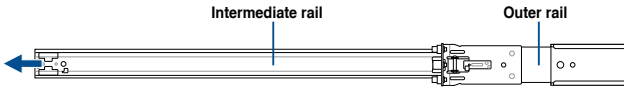

5. Slide the inner rail out of the intermediate rail until it clicks to a stop. Slide the white release tab outwards and remove the inner rail completely from the intermediate rail.

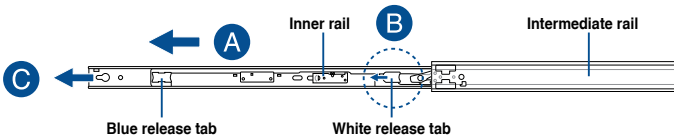

The blue release tab is available on 1200 mm rack rails. This blue release tab is used to further extend or retract the inner rail.

6. Repeat steps 2 to 5 for the other rack rail.



Ensure that the installed rack rails (left and right) are aligned, secured, and stable in place.

7. Align the inner rails with the studs on both sides of the server system, install the inner rails to the server system, then slide the inner rails toward the rear of the server system until it locks in place.

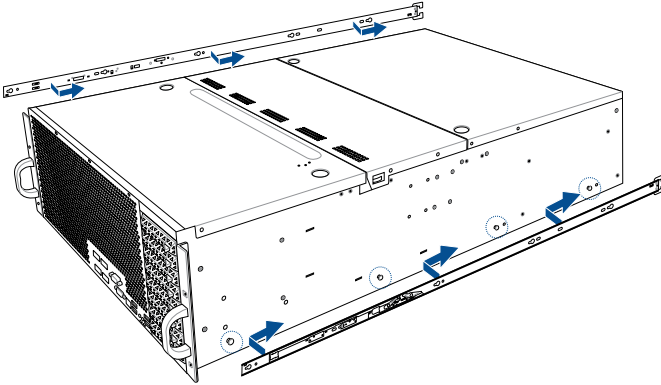

8. Secure the inner rails on both sides of the server system using the #6-32X4L screws.

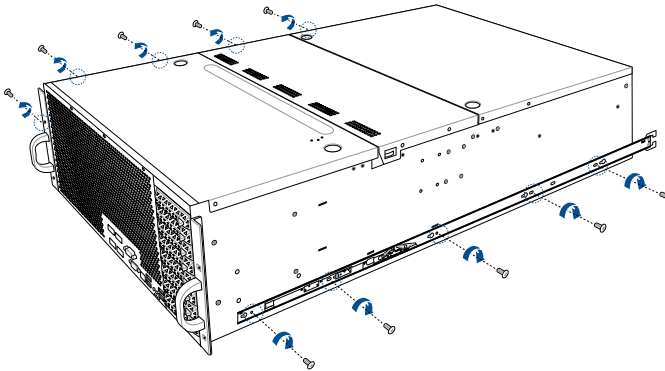

- Align the server system and gently insert it into the rack rails.

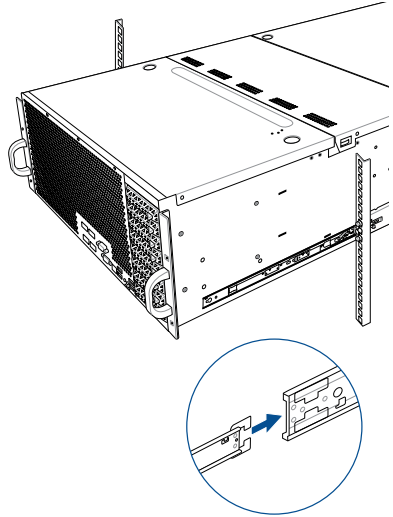

- (optional) Use the M5X20L screws to secure the rack rails to the rack post.

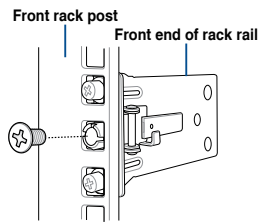

- Gently push the server system until it is completely installed into the rack rail.
 (optional) For 1200 mm rack rails, if the inner rail clicks to a stop while you are installing the server system into the rack rails, slide the blue release tab outwards and gently push the server system until it is completely installed into the rack rail.

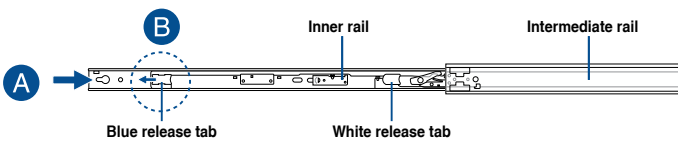

The blue release tab is available on 1200 mm rack rails. This blue release tab is used to further extend or retract the inner rail.

ESC8000 G4 Series Front View

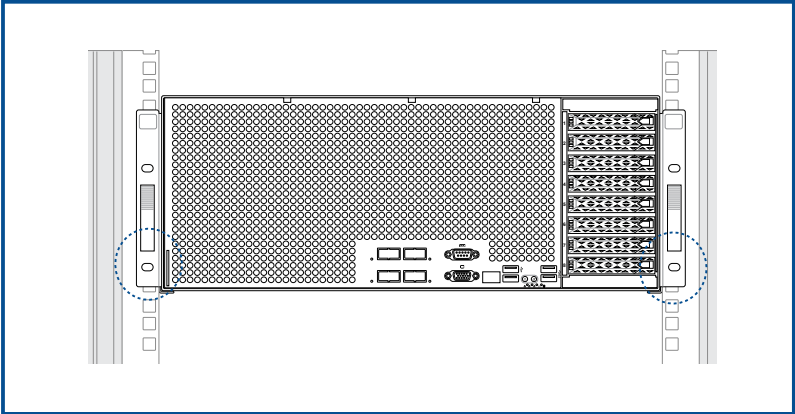

3.2 Cable management arm (optional for 1200 mm rack rails)

You can install an additional cable management arm (CMA) to the rack rails to help you manage the cables from your server system. The CMA is designed with movable parts that allow you to move the server system along the rack rail without the need to remove the CMA.

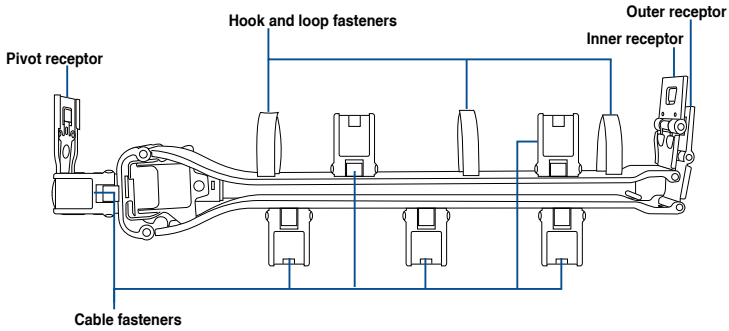

3.2.1 Attaching the cable management arm

Installing the cable management arm

To install the cable management arm:

1. Install the rack rails into the rack.



Refer to section 3.1 Rail Kit for the steps on installing the rack rails into the rack.

2. Press the round button on the pivot receptor, then rotate the pivot receptor to the left or right for a left pivot configuration or right pivot configuration.

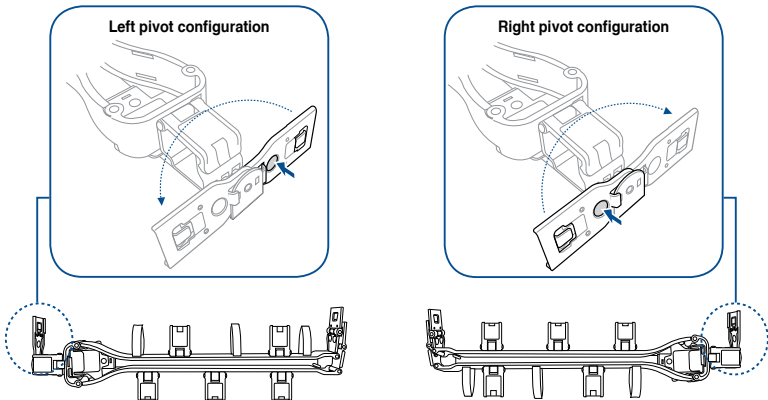

3. Align the three receptors on the CMA with the connectors on the rack rails.

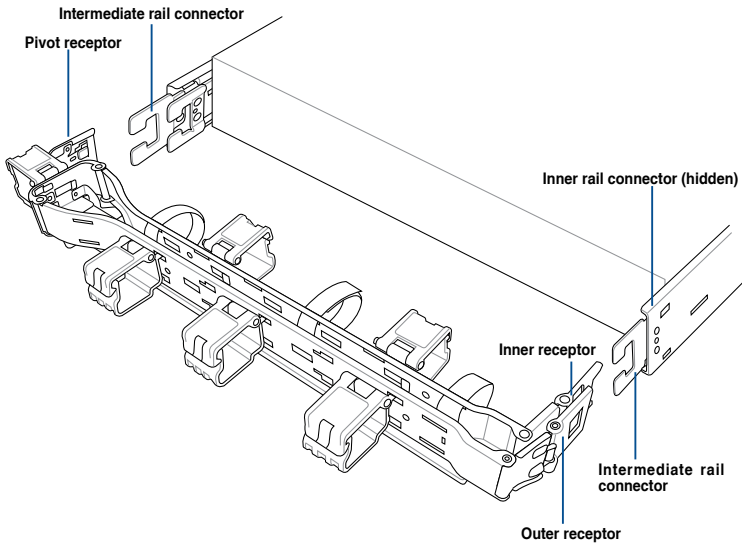

The installation steps in this section uses a **Left pivot configuration** as an example, the installation steps for a **Right pivot configuration** is similar.

4. Align and connect the inner receptor on the CMA with the connector on the inner rail.

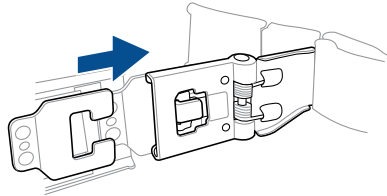

5. Align and connect the outer receptor on the CMA with the connector on the intermediate rail.

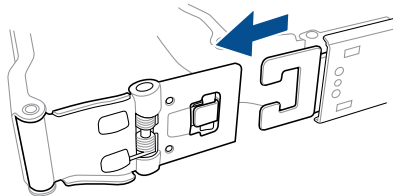

- 6. Align and connect the pivot receptor on the CMA with the connector on the other intermediate rail.

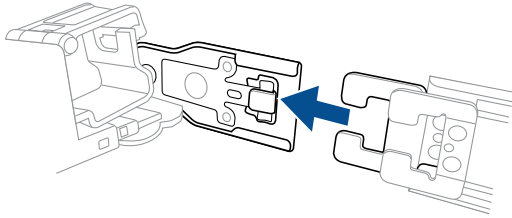

- 7. Pass the cables from the server system through the hook and loop fasteners and the cable fasteners on the CMA to complete.

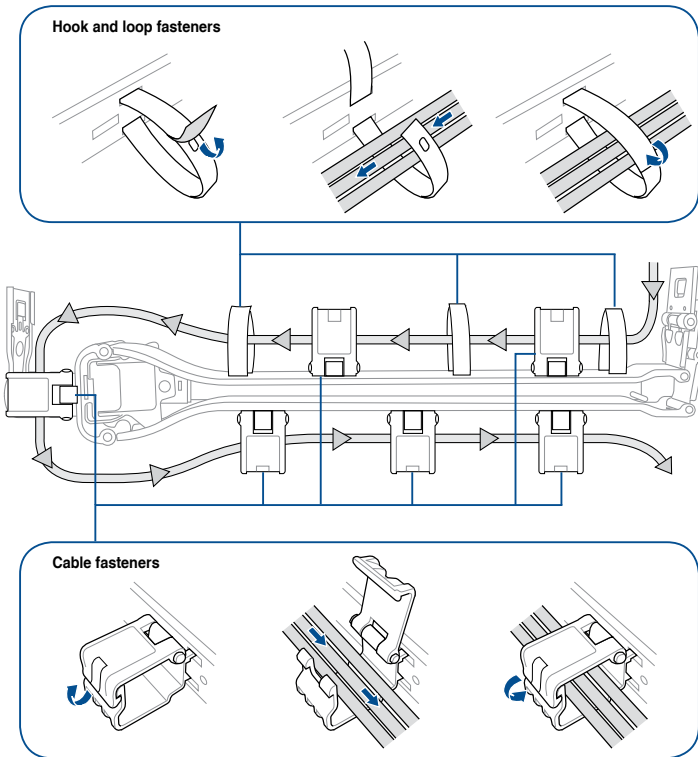

Motherboard Information

4

This chapter includes the motherboard layout and brief descriptions of the jumpers and internal connectors.

4.1 Z11PG-D24 Series Motherboard layout

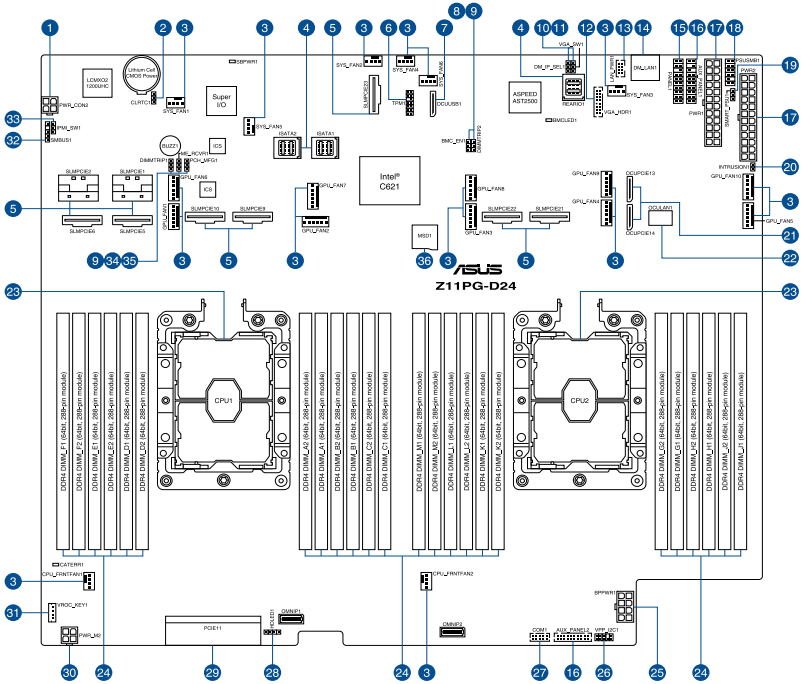

Layout contents

Internal connectors / Sockets / Jumpers / LEDs		Page
1.	PCIe SKU board power connector (4-pin PWR_CON2)	4-17
2.	Clear RTC RAM (3-pin CLRTC1)	4-4
3.	System fan connectors (4-pin SYS_FAN1-6; 4-pin CPU_FRNTFAN1-2; 6-pin GPU_FAN1-10)	4-13
4.	Mini-SAS HD connector (ISATA1-2; REARIO1)	4-11
5.	PCIe flex connectors (SLMPCIE1-2; SLMPCIE5-6; SLMPCIE9-10; SLMPCIE21-22; SLMPCIE23)	4-11
6.	TPM connector (20-1 pin TPM1)	4-12
7.	OCUUSB connector (OCUUSB1)	4-21
8.	Baseboard Management Controller setting (3-pin BMC_EN1)	4-6
9.	DDR4 thermal event setting (3-pin DIMMTRIP1-2)	4-7
10.	DMLAN setting (3-pin DM_IP_SEL1)	4-8
11.	VGA controller setting (3-pin VGA_SW1)	4-5
12.	VGA connector (16-pin VGA_HDR1)	4-23
13.	Rear LAN panel power connector (4-pin LAN_PWR1)	4-18
14.	Dedicated Management LAN port for iKVM (DM_LAN1)	4-25
15.	System panel connector (20-pin PANEL1)	4-14
16.	Auxiliary panel connector (20-2 pin AUX_PANEL1, 20-pin AUX_PANEL2)	4-15
17.	SSI power connectors (24-pin PWR1-2)	4-16
18.	Power Supply SMBus connector (12-1 pin PSUSMB1)	4-23
19.	Smart Ride Through (SmaRT) setting (3-pin SMART_PSU1)	4-8
20.	Chassis Intrusion (2-pin INTRUSION1)	4-19
21.	OCUPCIE connectors (OCUPCIE13-14)	4-22
22.	OCULAN connectors (OCULAN1)	4-22
23.	CPU socket	2-6
24.	DDR4 DIMM sockets	2-8
25.	Backplane power connectors (8-pin BPPWR1)	4-17
26.	VPP_I2C1 connector (10-1 pin VPP_I2C1)	4-21
27.	Serial port connector (10-1 pin COM1)	4-24
28.	Hard disk activity LED connector (4-pin HDLED1)	4-12
29.	PCIe expansion slot (PCIe11)	4-20
30.	M.2 board power connector (4-pin PWR_M2)	4-18
31.	VROC_KEY connector (4-pin VROC_KEY)	4-20
32.	System Management Bus (SMBUS) connector (5-1 pin SMBUS1)	4-24
33.	IPMI SW setting (3-pin IPMI_SW1)	4-5
34.	ME firmware force recovery setting (3-pin ME_RCVR1)	4-6
35.	PCH_MFG1 setting (3-pin PCH_MFG1)	4-7
36.	Micro SD card slot (MSD1)	4-19

4.2 Jumpers

1. Clear RTC RAM (3-pin CLRTC1)

This jumper allows you to clear the Real Time Clock (RTC) RAM in CMOS. You can clear the CMOS memory of date, time, and system setup parameters by erasing the CMOS RTC RAM data. The onboard button cell battery powers the RAM data in CMOS, which include system setup information such as system passwords.

To erase the RTC RAM:

1. Turn OFF the computer and unplug the power cord.
2. Move the jumper cap from pins 1–2 (default) to pins 2–3. Keep the cap on pins 2–3 for about 5–10 seconds, then move the cap back to pins 1–2.
3. Plug the power cord and turn ON the computer.
4. Hold down the key during the boot process and enter BIOS setup to re-enter data.



Except when clearing the RTC RAM, never remove the cap on CLRTC jumper default position. Removing the cap will cause system boot failure!



If the steps above do not help, remove the onboard battery and move the jumper again to clear the CMOS RTC RAM data. After the CMOS clearance, reinstall the battery.

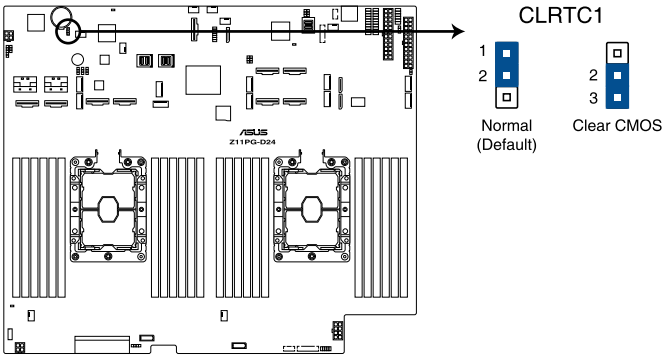

Z11PG-D24 Clear RTC RAM

2. VGA controller setting (3-pin VGA_SW1)

This jumper allows you to enable or disable the onboard VGA controller. Set to pins 1-2 to activate the VGA feature.

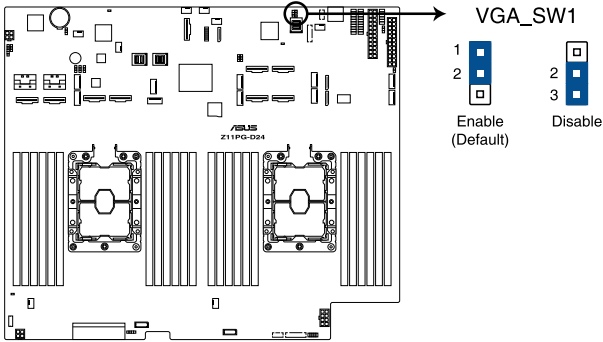

Z11PG-D24 VGA setting

3. IPMI SW setting (3-pin IPMI_SW1)

This jumper allows you to select which protocol in the GPU sensor to function.

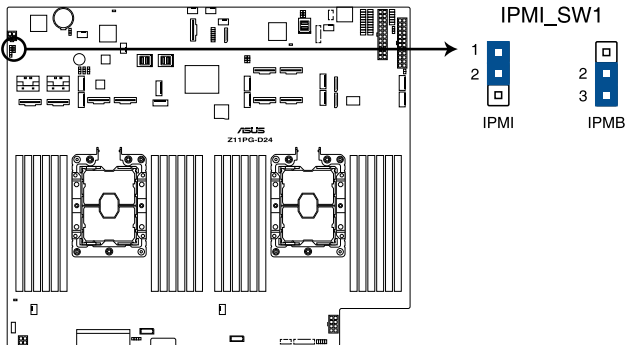

Z11PG-D24 IPMI_SW1 setting

4. ME firmware force recovery setting (3-pin ME_RCVR1)

This jumper allows you to quickly recover the Intel Management Engine (ME) firmware when it becomes corrupted.

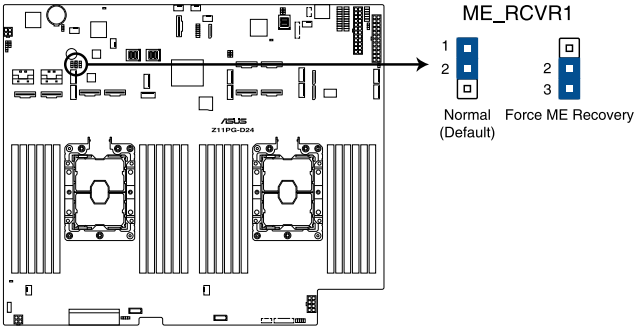

Z11PG-D24 ME recovery setting

5. Baseboard Management Controller setting (3-pin BMC_EN1)

This jumper allows you to enable (default) or disable on-board BMC. Ensure to set this BMC jumper to enabled to avoid system fan control and hardware monitor error.

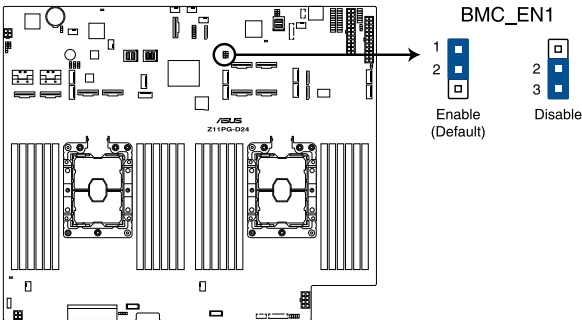

Z11PG-D24 BMC_EN1 setting

6. DDR4 thermal event setting (3-pin DIMMTRIP1-2)

These jumpers allow you to enable or disable DDR4 DIMM thermal sensing event pin.

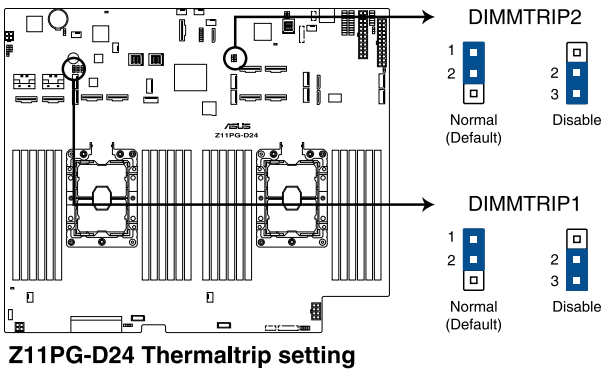

7. PCH_MFG1 setting (3-pin PCH_MFG1)

This jumper allows you to update the BIOS ME block.

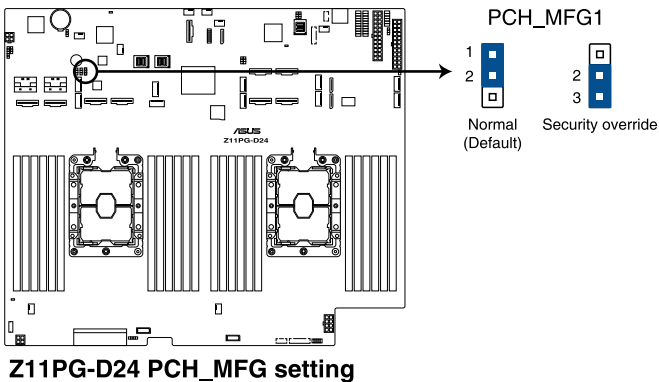

8. Smart Ride Through (Smart) setting (3-pin SMART_PSU1)

This jumper allows you to enable or disable the Smart Ride Through (SmaRT) function. This feature is enabled by default. Set to pins 2-3 to disable it. When enabled, SmaRT allows uninterrupted operation of the system during an AC loss event.

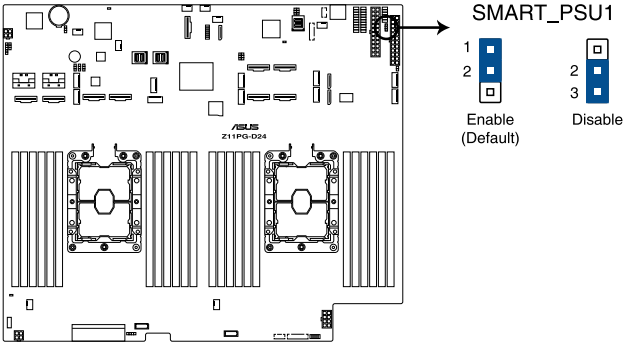

Z11PG-D24 Smart Ride Through setting

9. DMLAN setting (3-pin DM_IP_SEL1)

This jumper allows you to select the DMLAN setting. Set to pins 2-3 to force the DMLAN IP to static mode (IP=10.10.10.10, submask=255.255.255.0).

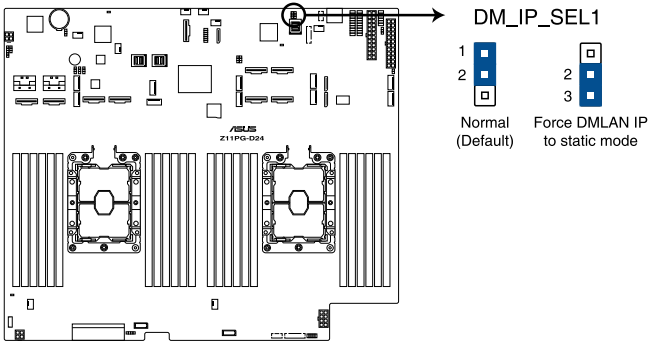

Z11PG-D24 DM_IP_SEL1 setting

4.3 Internal LEDs

1. Standby Power LED (SBPWR1)

The motherboard comes with a standby power LED. The green LED lights up to indicate that the system is ON, in sleep mode, or in soft-off mode. This is a reminder that you should shut down the system and unplug the power cable before removing or plugging in any motherboard component. The illustration below shows the location of the onboard LED.

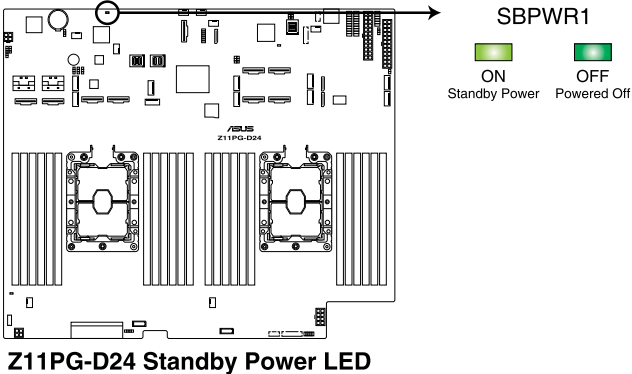

2. BMC LED (BMCLED1)

The BMC LED lights up to indicate that the on-board BMC is functional.

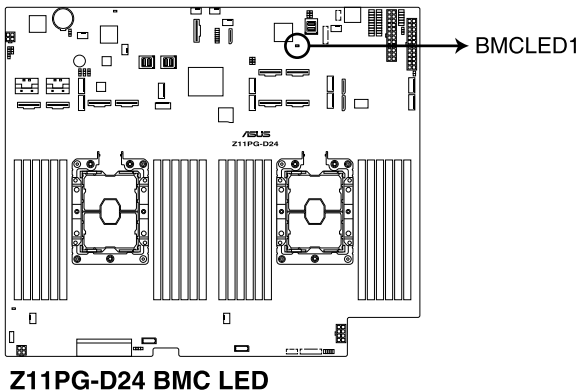

3. CATT LED (CATTERR1)

The CATT LED indicates that the system has experienced a fatal or catastrophic error and cannot continue to operate.

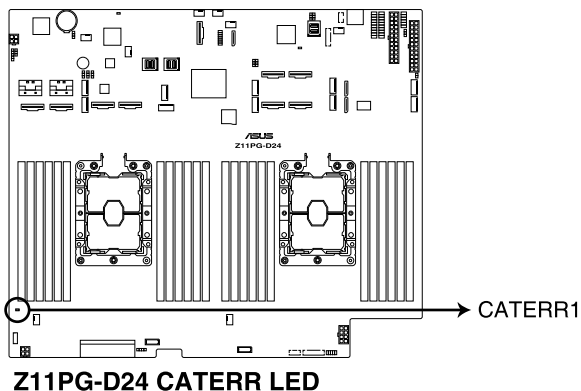

4.4 Internal connectors

1. PCIe flex connectors (SLMPCIE1-2; SLMPCIE5-6; SLMPCIE9-10; SLMPCIE21-22; SLMPCIE23)

These connectors allow you to connect PCIe flex cables to expand your motherboard with additional PCIe connectors. The flexible nature of the PCIe flex cable allows the PCIe connectors to be positioned freely inside the server system.

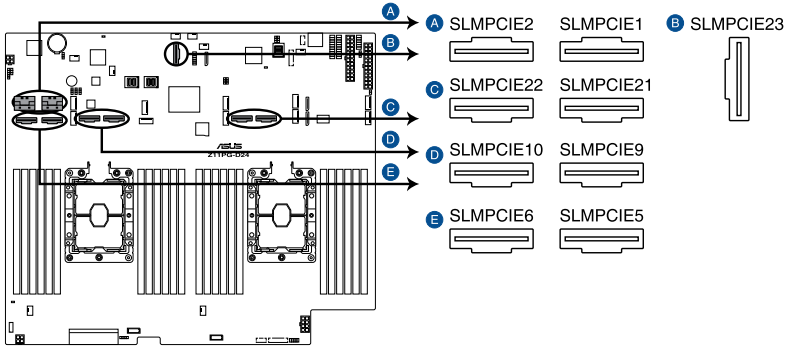

Z11PG-D24 SLMPCIE connectors



The SLMPCIE23 connector supports two PCIe x4 and two sSATA signals.

2. Mini-SAS HD connector (ISATA1-2; REARIO1)

This motherboard comes with mini Serial Attached SCSI (SAS) HD connectors, the storage technology that supports Serial ATA. Each connector supports up to four devices.

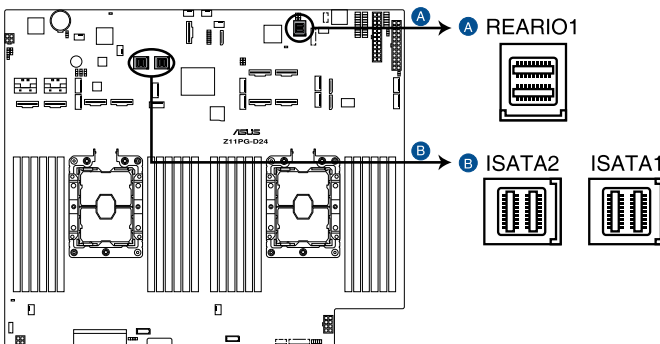

Z11PG-D24 Mini-SAS HD connectors

3. Hard disk activity LED connector (4-pin HDLED1)

This LED connector is for the storage add-on card cable connected to the SATA or SAS add-on card. The read or write activities of any device connected to the SATA or SAS add-on card causes the front panel LED to light up.

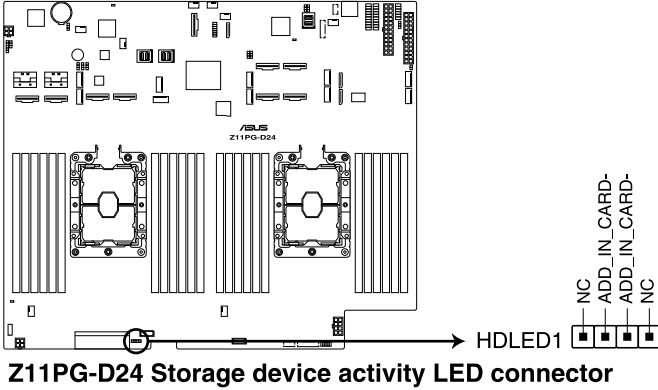

4. TPM connector (20-pin TPM1)

This connector supports a Trusted Platform Module (TPM) system, which can securely store keys, digital certificates, passwords, and data. A TPM system also helps enhance network security, protects digital identities, and ensures platform integrity.

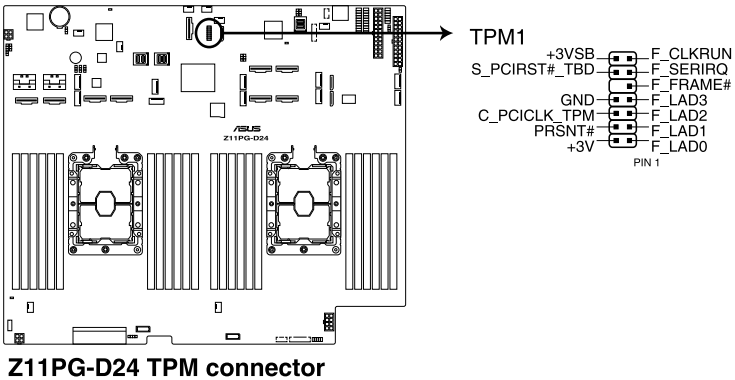

5. System fan connectors (4-pin SYS_FAN1-6; 4-pin CPU_FRNTFAN1-2; 6-pin GPU_FAN1-10)

The 4-pin fan connectors support cooling fans of 0.8A–1.0A (12 W max.), and the 6-pin fan connectors support 3.30 A – 3.95 A (47.4 W max.). Connect the fan cables to the fan connectors on the motherboard, making sure that the black wire of each cable matches the ground pin of the connector.



DO NOT forget to connect the fan cables to the fan connectors. Insufficient air flow inside the system may damage the motherboard components. These are not jumpers! DO NOT place jumper caps on the fan connectors!

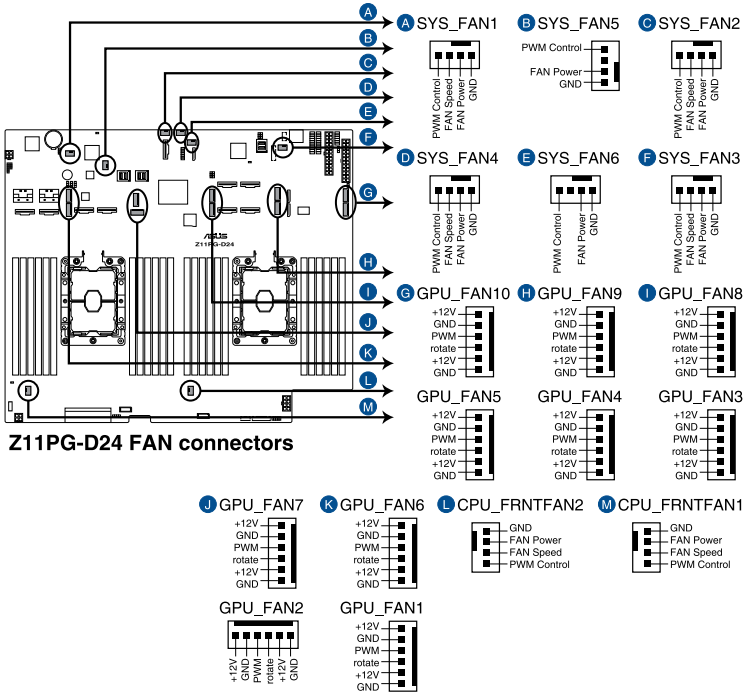

6. System panel connector (20-pin PANEL1)

This connector supports several chassis-mounted functions.

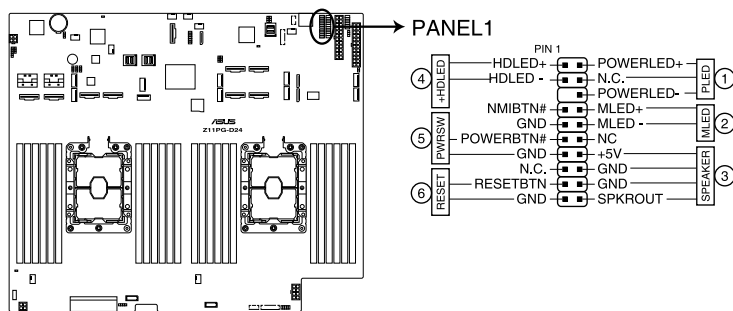

Z11PG-D24 System panel connector

1. System power LED (3-pin PLED)

This 3-pin connector is for the system power LED. Connect the chassis power LED cable to this connector. The system power LED lights up when you turn on the system power, and blinks when the system is in sleep mode.

2. Message LED (2-pin MLED)

This 2-pin connector is for the message LED cable that connects to the front message LED. The message LED is controlled by the BMC to indicate an abnormal event occurrence.

3. System warning speaker (4-pin SPEAKER)

This 4-pin connector is for the chassis-mounted system warning speaker. The speaker allows you to hear system beeps and warnings.

4. Hard disk drive activity LED (2-pin HDLED)

This 2-pin connector is for the HDD Activity LED. Connect the HDD Activity LED cable to this connector. The LED lights up or flashes when data is read from or written to the HDD.

5. ATX power button/soft-off button (2-pin PWRSW)

This connector is for the system power button. Pressing the power button turns the system on or puts the system in sleep or soft-off mode depending on the BIOS settings. Pressing the power switch for more than four seconds while the system is ON turns the system OFF.

6. Reset button (2-pin RESET)

This 2-pin connector is for the chassis-mounted reset button for system reboot without turning off the system power.

7. Auxiliary panel connector (20-2 pin AUX_PANEL1, 20-pin AUX_PANEL2)

This connector is for additional front panel features including front panel SMB, locator LED and switch, chassis intrusion, and LAN LEDs.

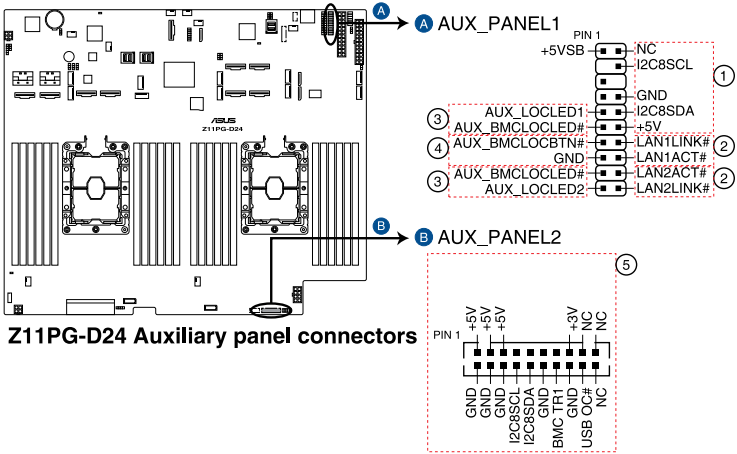

1. **Front panel SMB (6-1 pin FPSMB)**
These leads connect the front panel SMBus cable.
2. **LAN activity LED (2-pin LAN1_LED, LAN2_LED)**
These leads are for the Gigabit LAN activity LEDs on the front panel.
3. **Locator LED (2-pin LOCATORLED1, 2-pin LOCATORLED2)**
These leads are for the locator LED1 and LED2 on the front panel. Connect the Locator LED cables to these 2-pin connector. The LEDs will light up when the Locator button is pressed.
4. **Locator Button/Switch (2-pin LOCATORBTN)**
These leads are for the locator button on the front panel. This button queries the state of the system locator.
5. **LAN activity LED and USB port (USB power and OC pin)**
These leads are for the USB ports on the front or rear panel.

8. SSI power connectors (24-pin PWR1-2)

These connectors are for the SSI power supply plugs. The power supply plugs are designed to fit these connectors in only one orientation. Find the proper orientation and push down firmly until the connectors completely fit.



- DO NOT forget to connect both the 24-pin power plugs; otherwise, the system will not boot up.
- Use of a power supply unit (PSU) with a higher power output is recommended when configuring a system with more power-consuming devices. The system may become unstable or may not boot up if the power is inadequate.
- Ensure that your PSU can provide at least the minimum power required by your system.

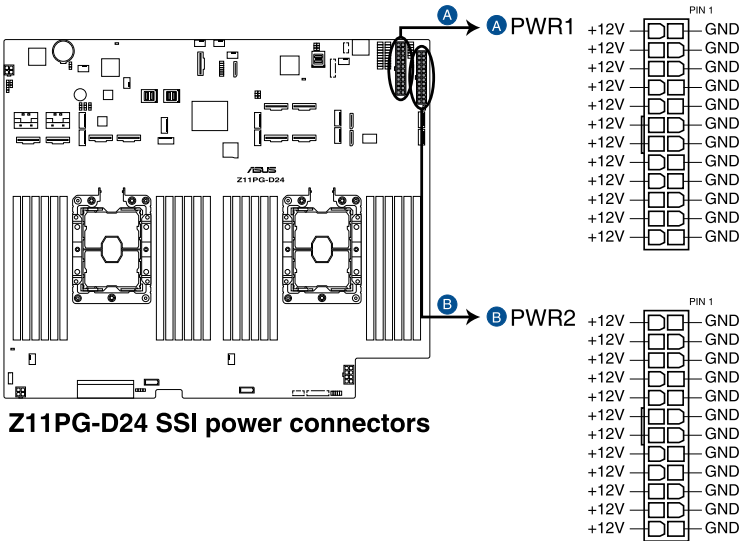

9. Backplane power connectors (8-pin BPPWR1)

These connectors are for the power supply plugs that connects to the backplane. The power supply plugs are designed to fit these connectors in only one orientation. Find the proper orientation and push down firmly until the connectors completely fit.

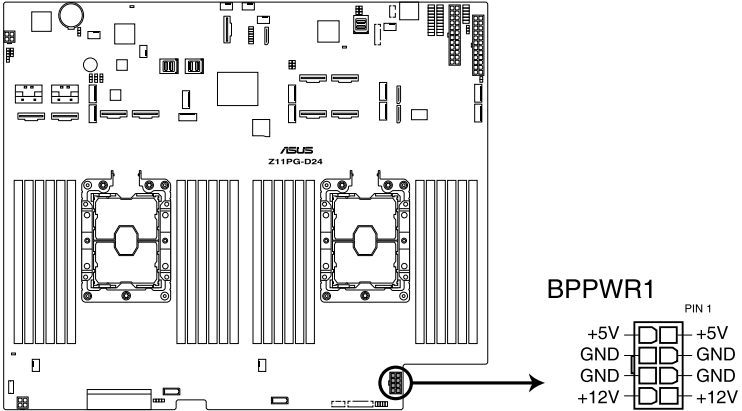

Z11PG-D24 BP power connector

10. PCIE SKU board power connector (4-pin PWR_CON2)

This connector is for the power supply plugs that connects to the PCIE SKU board. The power supply plugs are designed to fit these connectors in only one orientation. Find the proper orientation and push down firmly until the connectors completely fit.

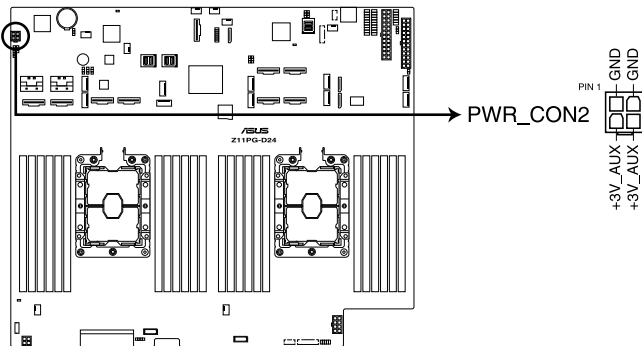

Z11PG-D24 CON2 power connector

11. M.2 board power connector (4-pin PWR_M2)

This connector is for the power supply plugs that connects to the M.2 board. The power supply plugs are designed to fit these connectors in only one orientation. Find the proper orientation and push down firmly until the connectors completely fit.

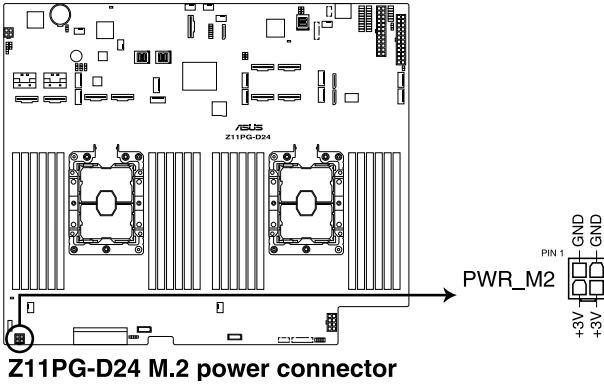

12. Rear LAN panel power connector (4-pin LAN_PWR1)

This connector is for the power supply plugs that connects to the rear LAN panel. The power supply plugs are designed to fit these connectors in only one orientation. Find the proper orientation and push down firmly until the connectors completely fit.

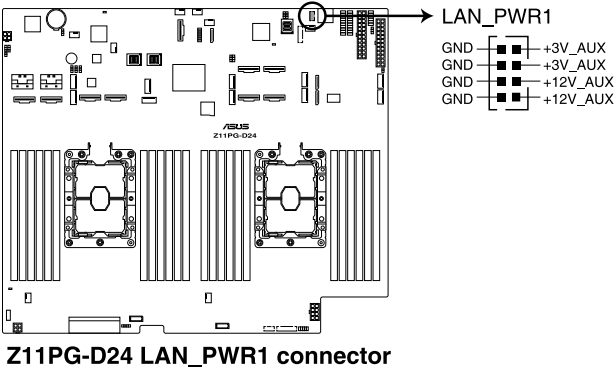

13. Chassis Intrusion (2-pin INTRUSION1)

These leads are for the intrusion detection feature for chassis with intrusion sensor or microswitch. When you remove any chassis component, the sensor triggers and sends a high level signal to these leads to record a chassis intrusion event. The default setting is to short the CHASSIS# and the GND pin by a jumper cap to disable the function.

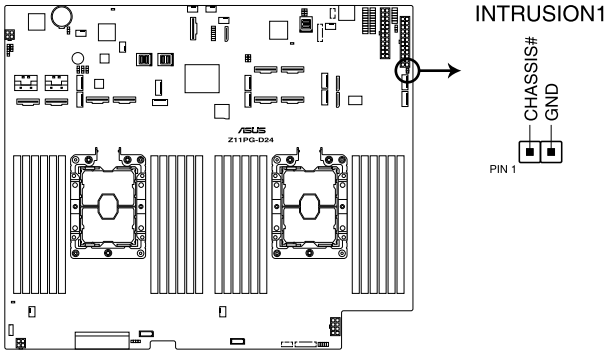

Z11PG-D24 Chassis Intrusion connector

14. Micro SD card slot (MSD1)

Your motherboard supports SD Memory Card v2.00 (SDHC) / v3.00 (SDXC).

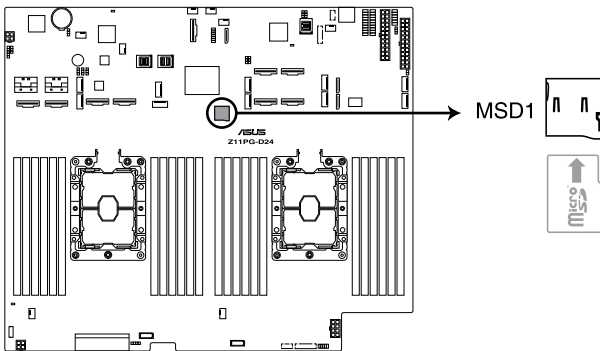

Z11PG-D24 MSD1



Disconnect all power (including redundant PSUs) from the existing system before you add or remove a Memory Card, then reboot the system to access the Memory Card.



Some memory cards may not be compatible with your motherboard. Ensure that you use only compatible memory cards to prevent loss of data, damage to your device, or memory card, or both.

15. VROC_KEY connector (4-pin VROC_KEY1)

This connector allows you to connect a KEY module to support Intel VMD RAID function.

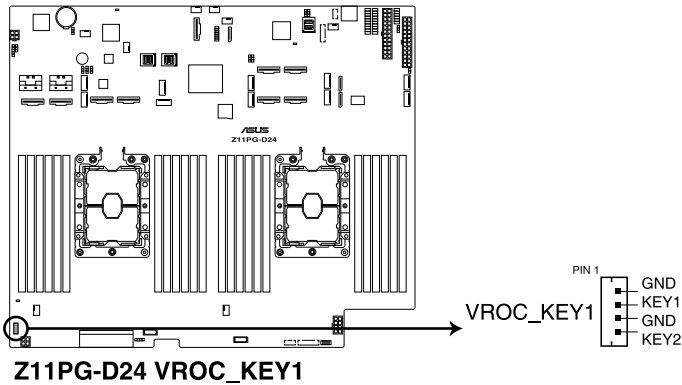

16. PCIe expansion slot (PCI11)

The onboard PCIe11 slot provides one Gen3 x8 link. This slot supports HBA/RAID cards and various server class high performance add-on cards.

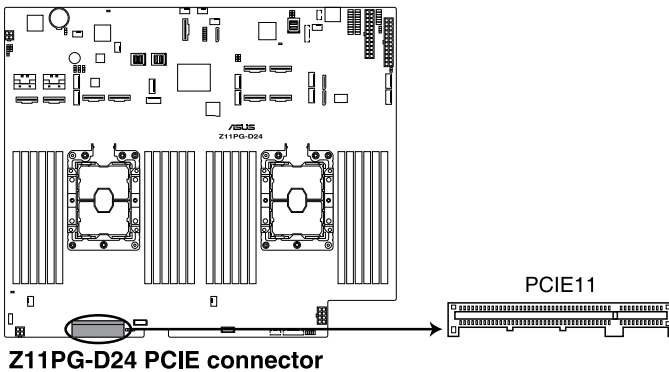

17. VPP_I2C1 connector (10-1 pin VPP_I2C1)

This connector is used for the Intel VMD function and sensor readings.

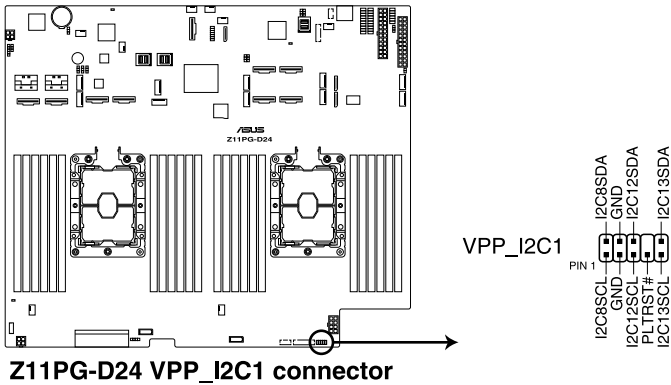

18. OCUUSB connector (OCUUSB1)

Connect a compatible USB module cable to the OCUUSB1 connector, and then install the module to a slot opening at the back or front of the system chassis. You can enjoy all the benefits of USB 3.0 including faster data transfer speeds of up to 5 Gbps, faster charging time for USB-chargeable devices, optimized power efficiency, and backward compatibility with USB 2.0. (OCUUSB1 connector is used for the front USB panel by default).

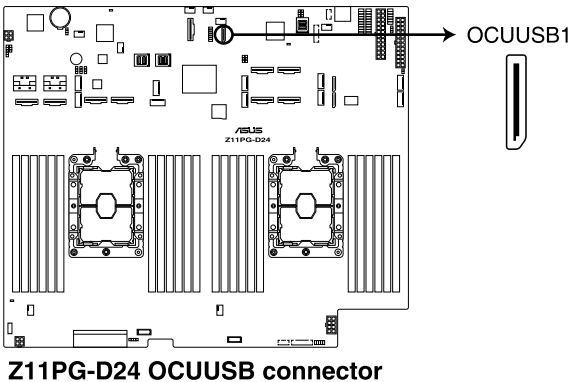

The USB port module is purchased separately.

19. OCUPCIE connectors (OCUPCIE13-14)

Connects the PCIE signal to the front riser card or NVME port on the backplane.

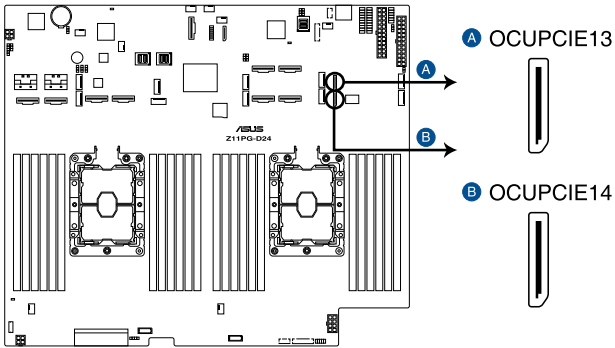

Z11PG-D24 OCUPCIE connectors

20. OCULAN connectors (OCULAN1)

Connects the PCIE signal to the LAN port on the back panel.

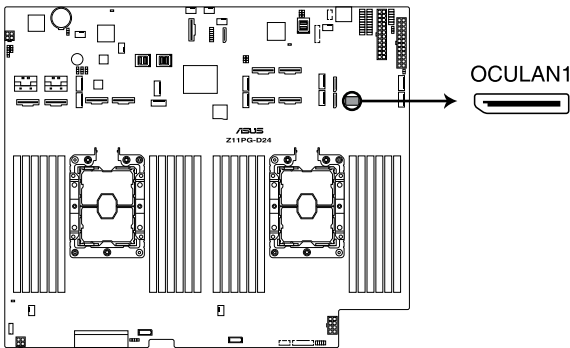

Z11PG-D24 OCULAN connector

21. Power Supply SMBus connector (12-1 pin PSUSMB1)

This connector allows you to connect SMBus (System Management Bus) to the power supply unit to read PSU information. Devices communicate with an SMBus host and/or other SMBus devices using the SMBus interface.

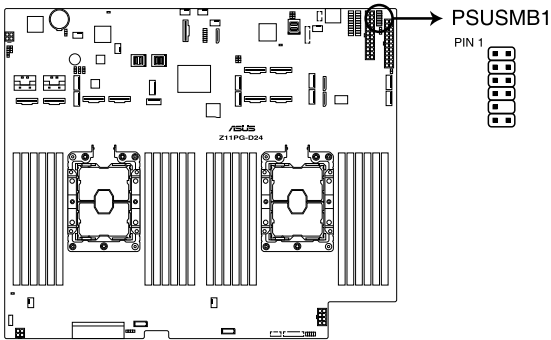

Z11PG-D24 Power supply SMBUS connector

22. VGA connector (16-pin VGA_HDR1)

This connector supports the VGA High Dynamic-Range interface.

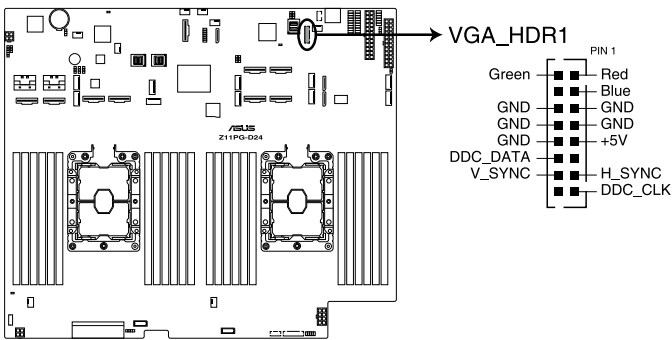

Z11PG-D24 Internal VGA connector

23. System Management Bus (SMBUS) connector (5-1 pin SMBUS1)

This connector controls the system and power management-related tasks. This connector processes the messages to and from devices rather than tripping the individual control lines.

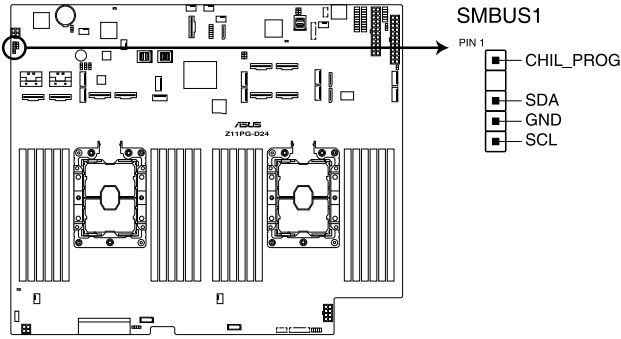

Z11PG-D24 SMBUS connectors

24. Serial port connector (10-1 pin COM1)

This connector is for a serial (COM) port. Connect the serial port module cable to this connector, then install the module to a slot opening at the back of the system chassis.

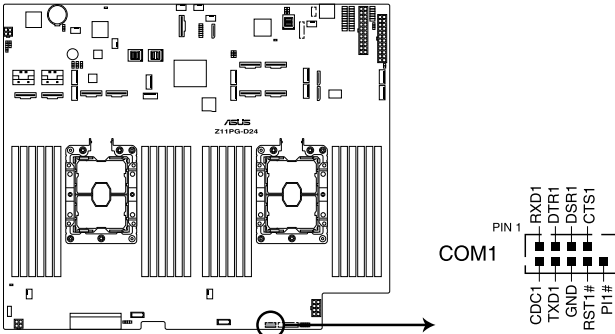

Z11PG-D24 Serial port connector



The COM module is purchased separately.

25. Dedicated Management LAN port for iKVM (DM_LAN1)

This port functions only when you enable ASMB9 Management card.

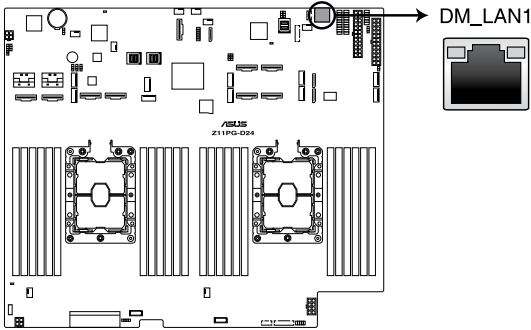

Z11PG-D24 DM_LAN1 connector

Dedicated Management LAN port (DM_LAN1) LED indications

Activity/Link LED		Speed LED	
Status	Description	Status	Description
OFF	No link	OFF	10 Mbps connection
ORANGE	Linked	ORANGE	100 Mbps connection
BLINKING	Data activity	GREEN	1 Gbps connection

BIOS Setup

5

This chapter tells how to change system settings through the BIOS Setup menus and describes the BIOS parameters.

5.1 Managing and updating your BIOS

The following utilities allow you to manage and update the motherboard Basic Input/Output System (BIOS) setup:

1. **ASUS CrashFree BIOS 3**

To recover the BIOS using a bootable USB flash disk drive when the BIOS file fails or gets corrupted.

2. **ASUS EzFlash**

Updates the BIOS using a USB flash disk.

3. **BUPDATER**

Updates the BIOS in DOS mode using a bootable USB flash disk drive.

Refer to the corresponding sections for details on these utilities.



Save a copy of the original motherboard BIOS file to a bootable USB flash disk drive in case you need to restore the BIOS in the future. Copy the original motherboard BIOS using the BUPDATER utility.

5.1.1 **ASUS CrashFree BIOS 3 utility**

The ASUS CrashFree BIOS 3 is an auto recovery tool that allows you to restore the BIOS file when it fails or gets corrupted during the updating process. You can update a corrupted BIOS file using a USB flash drive that contains the updated BIOS file.



Prepare a USB flash drive containing the updated motherboard BIOS before using this utility.

Recovering the BIOS from a USB flash drive

To recover the BIOS from a USB flash drive:

1. Insert the USB flash drive with the original or updated BIOS file to one USB port on the system.
2. The utility will automatically recover the BIOS. It resets the system when the BIOS recovery finished.



DO NOT shut down or reset the system while recovering the BIOS! Doing so would cause system boot failure!



The recovered BIOS may not be the latest BIOS version for this motherboard. Visit the ASUS website at www.asus.com to download the latest BIOS file.

5.1.2 ASUS EZ Flash Utility

The ASUS EZ Flash Utility feature allows you to update the BIOS without having to use a DOS-based utility.



Before you start using this utility, download the latest BIOS from the ASUS website at www.asus.com.

To update the BIOS using EZ Flash Utility:

1. Insert the USB flash disk that contains the latest BIOS file into the USB port.
2. Enter the BIOS setup program. Go to the **Tool** menu then select **Start EzFlash**. Press <Enter>.

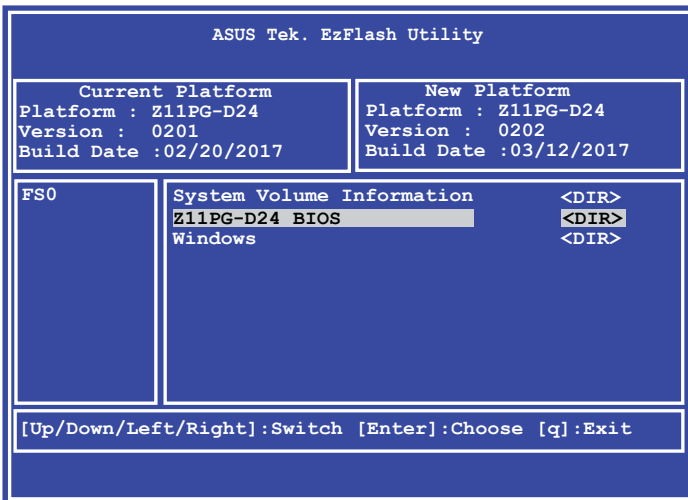

3. Press <Tab> to switch to the **Drive** field.
4. Press the Up/Down arrow keys to find the USB flash disk that contains the latest BIOS, then press <Enter>.
5. Press <Tab> to switch to the **Folder Info** field.
6. Press the Up/Down arrow keys to find the BIOS file, and then press <Enter> to perform the BIOS update process. Reboot the system when the update process is done.



-
- This function can support devices such as a USB flash disk with FAT 32/16 format and single partition only.
 - DO NOT shut down or reset the system while updating the BIOS to prevent system boot failure!
-



Ensure to load the BIOS default settings to ensure system compatibility and stability. Press <F5> and select Yes to load the BIOS default settings.

5.1.3 BUPDATER utility



The succeeding BIOS screens are for reference only. The actual BIOS screen displays may not be the same as shown.

The BUPDATER utility allows you to update the BIOS file in DOS environment using a bootable USB flash disk drive with the updated BIOS file.

Updating the BIOS file

To update the BIOS file using the BUPDATER utility:

1. Visit the ASUS website at www.asus.com and download the latest BIOS file for the motherboard. Save the BIOS file to a bootable USB flash disk drive.
2. Download the BUPDATER utility (BUPDATER.exe) from the ASUS support website at support.asus.com to the bootable USB flash disk drive you created earlier.
3. Boot the system in DOS mode, then at the prompt, type:

```
BUPDATER /i[filename].CAP
```

where [filename] is the latest or the original BIOS file on the bootable USB flash disk drive, then press <Enter>.

```
A:\>BUPDATER /i[file name]CAP
```

- The utility verifies the file, then starts updating the BIOS file.

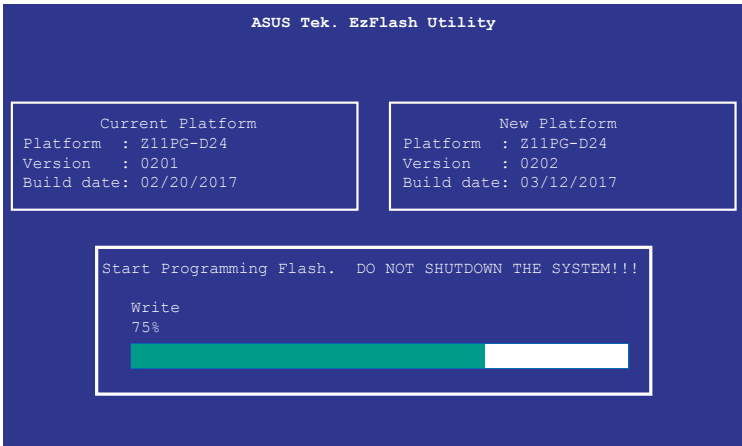

DO NOT shut down or reset the system while updating the BIOS to prevent system boot failure!

- The utility returns to the DOS prompt after the BIOS update process is completed. Reboot the system from the hard disk drive.

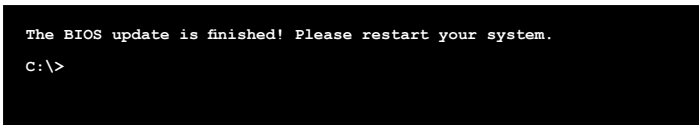

5.2 BIOS setup program

This motherboard supports a programmable firmware chip that you can update using the provided utility described in section **5.1 Managing and updating your BIOS**.

Use the BIOS Setup program when you are installing a motherboard, reconfiguring your system, or prompted to “Run Setup.” This section explains how to configure your system using this utility.

Even if you are not prompted to use the Setup program, you can change the configuration of your computer in the future. For example, you can enable the security password feature or change the power management settings. This requires you to reconfigure your system using the BIOS Setup program so that the computer can recognize these changes and record them in the CMOS RAM of the firmware chip.

The firmware chip on the motherboard stores the Setup utility. When you start up the computer, the system provides you with the opportunity to run this program. Press during the Power-On Self-Test (POST) to enter the Setup utility; otherwise, POST continues with its test routines.

If you wish to enter Setup after POST, restart the system by pressing <Ctrl+Alt+Delete>, or by pressing the reset button on the system chassis. You can also restart by turning the system off and then back on. Do this last option only if the first two failed.

The Setup program is designed to make it as easy to use as possible. Being a menu-driven program, it lets you scroll through the various sub-menus and make your selections from the available options using the navigation keys.



-
- The default BIOS settings for this motherboard apply for most conditions to ensure optimum performance. If the system becomes unstable after changing any BIOS settings, load the default settings to ensure system compatibility and stability. Press <F5> and select Yes to load the BIOS default settings.
 - The BIOS setup screens shown in this section are for reference purposes only, and may not exactly match what you see on your screen.
 - Visit the ASUS website (www.asus.com) to download the latest BIOS file for this motherboard.
-

5.2.1 BIOS menu screen

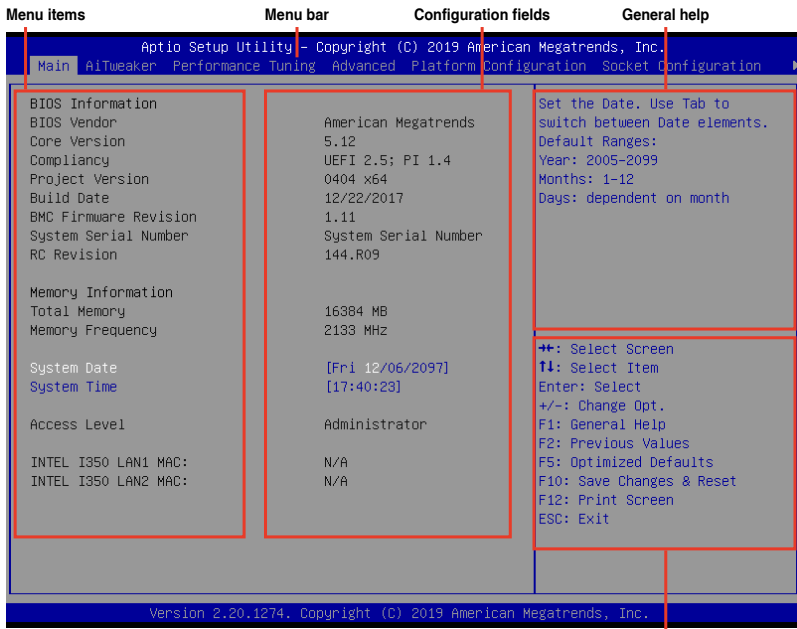

Navigation keys

5.2.2 Menu bar

The menu bar on top of the screen has the following main items:

Main	For changing the basic system configuration
Ai Tweaker	For changing the overclocking settings
Performance Tuning	For changing the performance settings
Advanced	For changing the advanced system settings
Platform Configuration	For changing the platform settings
Socket Configuration	For changing the socket settings
Event Logs	For changing the event log settings
Server Mgmt	For changing the server mgmt settings
Security	For changing the security settings
Boot	For changing the system boot configuration
Tool	For configuring options for special functions
Save & Exit	For selecting the save & exit options

To select an item on the menu bar, press the right or left arrow key on the keyboard until the desired item is highlighted.

5.2.3 Menu items

The highlighted item on the menu bar displays the specific items for that menu. For example, selecting **Main** shows the Main menu items.

The other items (such as **Advanced**) on the menu bar have their respective menu items.

5.2.4 Submenu items

A solid triangle before each item on any menu screen means that the item has a submenu. To display the submenu, select the item then press <Enter>.

5.2.5 Navigation keys

At the bottom right corner of a menu screen are the navigation keys for the BIOS setup program. Use the navigation keys to select items in the menu and change the settings.

5.2.6 General help

At the top right corner of the menu screen is a brief description of the selected item.

5.2.7 Configuration fields

These fields show the values for the menu items. If an item is user-configurable, you can change the value of the field opposite the item. You cannot select an item that is not user-configurable.

A configurable field is enclosed in brackets, and is highlighted when selected. To change the value of a field, select it and press <Enter> to display a list of options.

5.2.8 Pop-up window

Select a menu item and press <Enter> to display a pop-up window with the configuration options for that item.

5.2.9 Scroll bar

A scroll bar appears on the right side of a menu screen when there are items that do not fit on the screen. Press the Up/Down arrow keys or <Page Up> / <Page Down> keys to display the other items on the screen.

5.3 Main menu

When you enter the BIOS Setup program, the Main menu screen appears. The Main menu provides you an overview of the basic system information, and allows you to set the system date, time, language, and security settings.

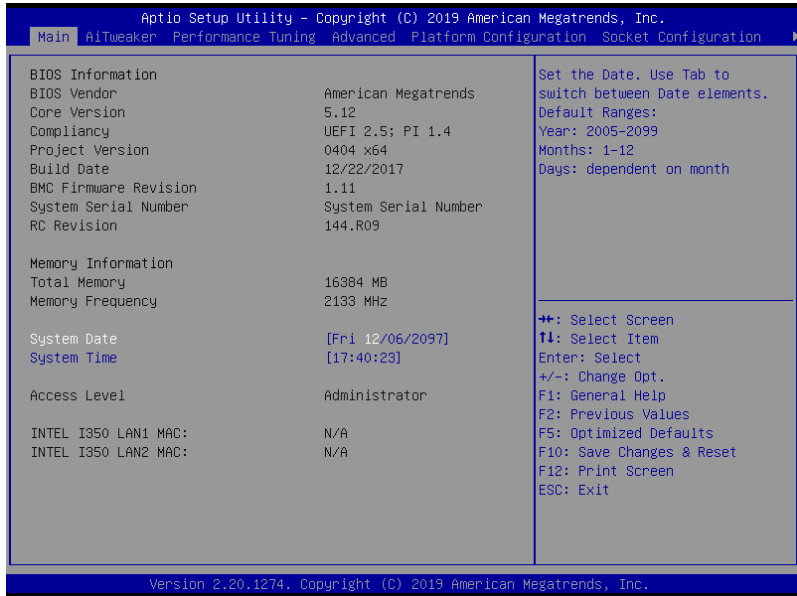

5.3.1 System Date [Day xx/xx/xxxx]

Allows you to set the system date.

5.3.2 System Time [xx:xx:xx]

Allows you to set the system time.

5.4 Ai Tweaker

The Ai Tweaker menu items allow you to configure overclocking-related items.



Be cautious when changing the settings of the Ai Tweaker menu items. Incorrect field values can cause the system to malfunction.



The configuration options for this section vary depending on the CPU and DIMM model you installed on the motherboard.

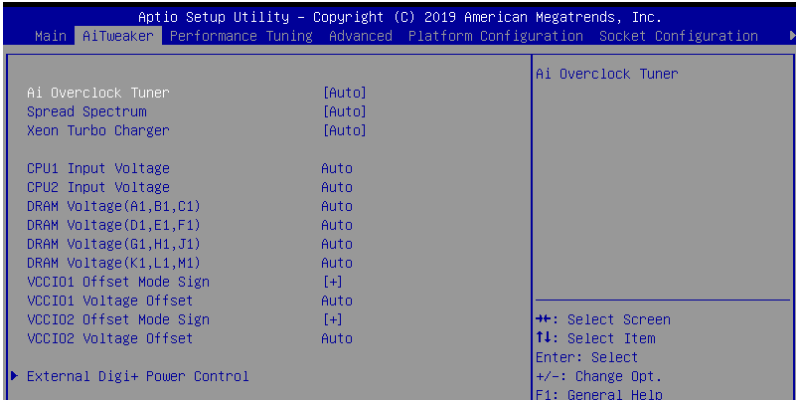

Ai Overclock Tuner [Auto]

This item allows you to select the CPU overclocking options to achieve the desired CPU internal frequency. Select any of these preset overclocking configuration options:

- [Auto] Automatically optimizes the BCLK frequency.
- [Manual] Manually adjust the and BCLK frequency.
- [OC Tune] If you install memory modules supporting the eXtreme Memory Profile (XMP) Technology, choose this item to set the profiles supported by your memory modules for optimizing the system performance.



The following item appears only when you set **Ai Overclock Tuner** to **[Manual]**.

BCLK Frequency [100.0]

This item allows you to set the BCLK (base clock) frequency to enhance the system performance. Use the <+> or <-> to adjust the value.



The following item appears only when you set **Ai Overclock Tuner** to **[OC Tune]**.

OC tune Level [Level 1]

This item allows you to set the OC tune level.
Configuration options: [Level 1] [Level 2] [Level 3]

Spread Spectrum [Auto]

Allows you to select the spread spectrum behavior. Disabling this option may enhance BCLK overlocking ability.

Configuration options: [Auto] [Disabled] [Enabled]

Xeon Turbo Charger [Auto]

Allows you to select the Xeon Turbo Charger behavior.

Configuration options: [Auto] [Disabled] [Enabled]

CPU1-2 Input Voltage [Auto]

This item allows you to configure the input voltage fed to the processors by the external voltage regulator.

DRAM Voltage (A1, B1, C1) / (D1, E1, F1) / (G1, H1, J1) / (K1, L1, M1)

This item allows you to configure the power supply for the DRAM.

VCCIO1-2 Offset Mode Sign [+]

[+] To offset the voltage by a positive value.

[-] To offset the voltage by a negative value.

VCCIO1-2 Voltage Offset [Auto]

This item allows you to configure the CPU core voltage offset value.

External DIGI+ Power Control

CPU1-2 Load-line Calibration [Auto]

Higher levels of the load-line calibration can get a higher voltage and better overlocking performance, but increases the CPU and VRM thermal production. Select from levels 1 to 9 to adjust the CPU power voltage from 0% to 125%.

Configuration options [Auto] [Level 1] - [Level 9]



The actual performance boost may vary depending on your CPU specification.



DO NOT remove the thermal module. The thermal conditions should be monitored.

CPU1-2 Current Capability [Auto]

The CPU current capability adjusts the total power range for CPU overlocking. A higher value provides a wider total power range and extends the overlocking frequency range simultaneously.

Configuration options: [Auto] [100%] [110%] [120%] [130%] [140%]



Configure higher values when overlocking or under a high CPU loading for extra power support.

CPU1-2 Power Phase Control [Auto]

This item allows you to set the power phase control of the CPU.

- [Auto] Automatically set the phase control mode.
[Extreme] Set to the full phase mode.



DO NOT remove the thermal module. The thermal conditions should be monitored.

CPU1-2 Thermal Control [120]

This item allows you to configure the thermal control value. A higher temperature provides a wider CPU power thermal range and extends the over clocking tolerance to enlarge the overclocking potential.



DO NOT remove the thermal module. The thermal conditions should be monitored.

DRAM-ABC / DRAM-DEF / DRAM-GHJ / DRAM-KLM Current Capability[100%]

The DRAM current capability adjusts the total power range for DRAM overclocking. A higher value provides a wider total power range and extends the overclocking frequency range simultaneously.

Configuration options: [100%] [110%] [120%] [130%] [140%]

DRAM-ABC / DRAM-DEF / DRAM-GHJ / DRAM-KLM Phase Control [100%]

This item allows you to set the power phase control of the DRAM.

- [Auto] Automatically set the phase control mode.
[Extreme] Set to the full phase mode.



DO NOT remove the thermal module. The thermal conditions should be monitored.

5.4 Performance Tuning menu

The Performance Tuning menu items allow you to change performance related settings for different scenarios.

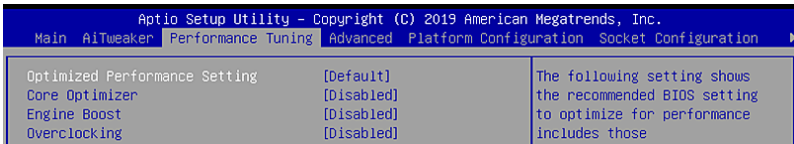

Optimized Performance Setting [Default]

Allows you to select performance settings for different scenarios.

[Default] Default settings.

[By Benchmark] Optimize for different kinds of benchmarks. Select this option, then select a benchmark type from the >> list.

[By Workload] Optimize for different kinds of workloads. Select this option, then select a workload type from the >> list.

Configuration options:

[Peak Frequency Optimized] - Applies settings with performance and power consumption balance. Recommended for users that need higher performance.

[Latency Optimized] - Applies settings with low latency results. Recommended for latency-sensitive users.

[Power Efficient Optimized] - Applies settings with power efficiency. Recommended for general users.

[HPC] - Applies settings with optimized compute capability. Recommend for traditional HPC applications.



Core Optimizer and **Engine Boost** appear only when you set **Optimized Performance Setting** to **[Default]** or **[By Benchmark]**.

Core Optimizer [Disabled]

Enable this item to keep the processor operating at the turbo frequency.

Configuration options: [Disabled] [Enabled]

Engine Boost [Disabled]

Enable this item to boost the CPU's frequency.

Configuration options: [Disabled] [Level1] [Level2] [Level3(Max)]



Operate with an ambient temperature of 25oC or lower for optimized performance.

Overclocking [Disabled]

Enable this item to increase the CPU's clock.

Configuration options: [Disabled] [Level1] [Level2] [Level3(Max)]



Please be aware that overclocking might cause component damage or system crash and reduce the lifespan of the system and the CPU. Use this tool at your own risk.

5.5 Advanced menu

The Advanced menu items allow you to change the settings for the CPU and other system devices.



Take caution when changing the settings of the Advanced menu items. Incorrect field values can cause the system to malfunction.

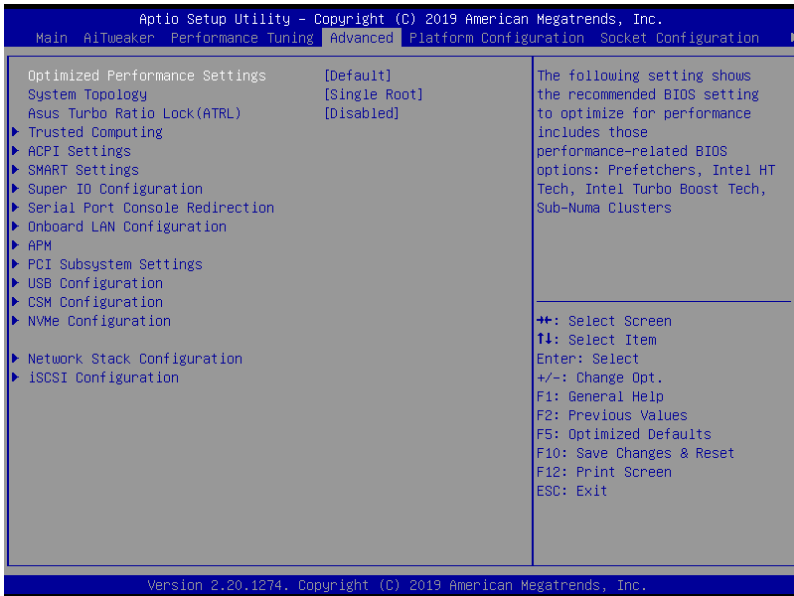

Optimized Performance Settings [Default]

This option allows you to select a recommended BIOS setting to optimize performance.

System Topology [Single Root]

Allows you to switch the system PCI-E topology.

Configuration options: [Single Root] [Dual Root]

Asus Turbo Ratio Lock (ATRL) [Disabled]

Allows you to keep the processor operating at the turbo highest frequency for maximum performance.

Configuration options: [Disabled] [Enabled]

5.5.1 Trusted Computing

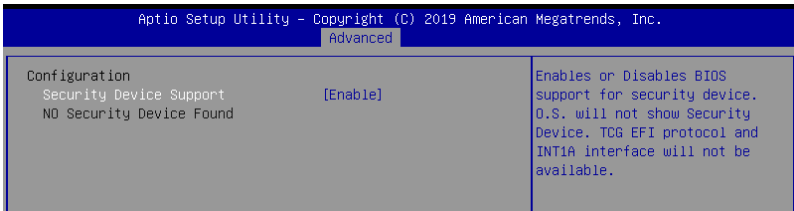

Configuration

Security Device Support [Disabled]

Allows you to enable or disable the BIOS support for security device.

Configuration options: [Disabled] [Enabled]

5.5.2 ACPI Settings

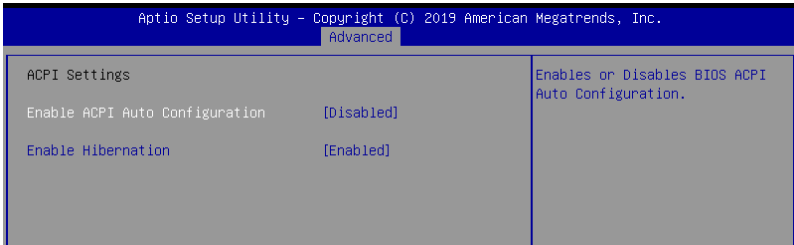

Enable ACPI Auto Configuration [Disabled]

Allows you to enable or disable the BIOS ACPI Auto Configuration.

Configuration options: [Disabled] [Enabled]

Enable Hibernation [Enabled]

Allows you to enable or disable the ability of the system to hibernate (OS/Sleep State).

Configuration options: [Disabled] [Enabled]



This option may be not effective with some OS.

5.5.3 Smart Settings

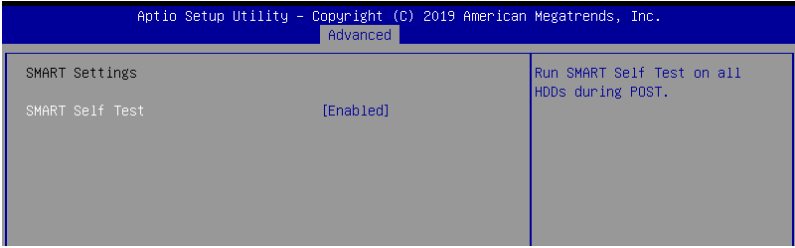

SMART Self Test [Enabled]

Allows you to run SMART Self Test on all HDDs during POST.

Configuration options: [Disabled] [Enabled]

5.5.4 Super IO Configuration

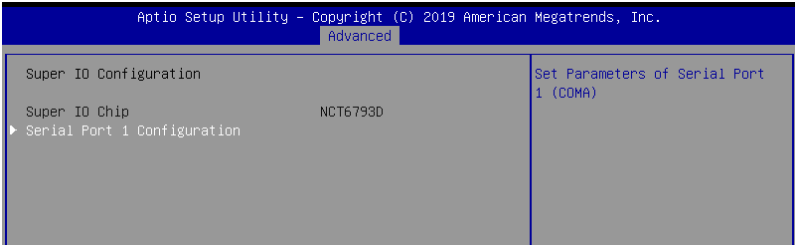

Serial Port 1 Configuration

Allows you to set the parameters of Serial Port 1.

Serial Port [Enabled]

Allows you to enable or disable Serial Port.

Configuration options: [Disabled] [Enabled]



The following item appears only when you set **Serial Port** to **[Enabled]**.

Change Settings [Auto]

Allows you to choose the setting for Super IO device.

Configuration options: [Auto] [IO=3F8h; IRQ=4;]

[IO=3F8h; IRQ=3, 4, 5, 6, 7, 9, 10, 11, 12;]

[IO=2F8h; IRQ=3, 4, 5, 6, 7, 9, 10, 11, 12;]

[IO=3E8h; IRQ=3, 4, 5, 6, 7, 9, 10, 11, 12;]

[IO=2E8h; IRQ=3, 4, 5, 6, 7, 9, 10, 11, 12;]

5.5.5 Serial Port Console Redirection

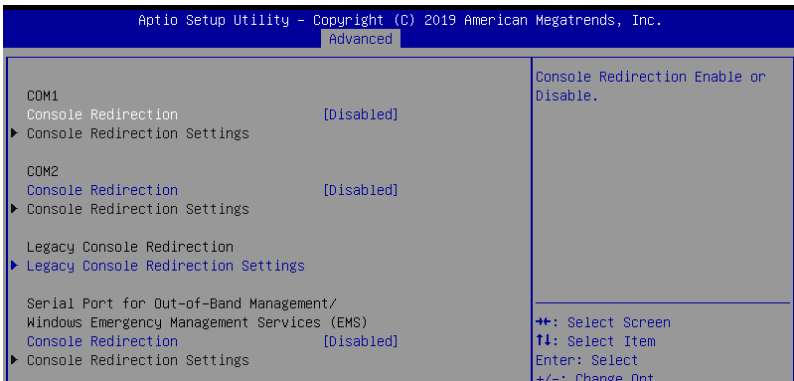

COM1/COM2

Console Redirection [Disabled]

Allows you to enable or disable the console redirection feature.

Configuration options: [Disabled] [Enabled]



The following item appears only when you set **Console Redirection** to **[Enabled]**.

Console Redirection Settings

These items become configurable only when you enable the **Console Redirection** item. The settings specify how the host computer and the remote computer (which the user is using) will exchange data. Both computers should have the same or compatible settings.

Terminal Type [VT-UTF8]

Allows you to set the terminal type.

[VT100] ASCII char set.

[VT100+] Extends VT100 to support color, function keys, etc.

[VT-UTF8] Uses UTF8 encoding to map Unicode chars onto 1 or more bytes.

[ANSI] Extended ASCII char set.

Bits per second [57600]

Selects serial port transmission speed. The speed must be matched on the other side. Long or noisy lines may require lower speeds.

Configuration options: [9600] [19200] [38400] [57600] [115200]

Data Bits [8]

Configuration options: [7] [8]

Parity [None]

A parity bit can be sent with the data bits to detect some transmission errors. [Mark] and [Space] parity do not allow for error detection.

[None]	None
[Even]	parity bit is 0 if the num of 1's in the data bits is even
[Odd]	parity bit is 0 if num of 1's in the data bits is odd
[Mark]	parity bit is always 1
[Space]	parity bit is always 0

Stop Bits [1]

Stop bits indicate the end of a serial data packet. (A start bit indicates the beginning.) The standard setting is 1 stop bit. Communication with slow devices may require more than 1 stop bit.

Configuration options: [1] [2]

Flow Control [Hardware RTS/CTS]

Flow control can prevent data loss from buffer overflow. When sending data, if the receiving buffers are full, a "stop" signal can be sent to stop the data flow. Once the buffers are empty, a "start" signal can be sent to re-start the flow. Hardware flow control uses two wires to send start/stop signals.

Configuration options: [None] [Hardware RTS/CTS]

VT -UTF8 Combo Key Support [Enabled]

This allows you to enable the VT -UTF8 Combination Key Support for ANSI/VT100 terminals.

Configuration options: [Disabled] [Enabled]

Recorder Mode [Disabled]

With this mode enabled only text will be sent. This is to capture Terminal data.

Configuration options: [Disabled] [Enabled]

Legacy OS Redirection Resolution [80x24]

This allows you to set the number of rows and columns supported on the Legacy OS.

Configuration options: [80x24] [80x25]

Putty Keypad [VT100]

This allows you to select the FunctionKey and Keypad on Putty.

Configuration options: [VT100] [LINUX] [XTERMR6] [SCO] [ESCN] [VT400]

Redirection After BIOS POST [Always Enable]

This setting allows you to specify if Bootloader is selected than Legacy console redirection.

Configuration options: [Always Enable] [Bootloader]

Legacy Console Redirection Settings

Legacy Console Redirection Port [COM1]

Allows you to select a COM port to display redirection of Legacy OS and Legacy OPROM Messages.

Configuration options: [COM1] [COM2]

Serial Port for Out-of-Band Management/Windows Emergency Management Services (EMS)

Console Redirection [Disabled]

Allows you to enable or disable the console redirection feature.

Configuration options: [Disabled] [Enabled]



The following item appears only when you set **Console Redirection** to **[Enabled]**.

Console Redirection Settings

Out-of-Band Mgmt Port [COM1]

Microsoft Windows Emergency Management Services (EMS) allow for remote management of a Windows Server OS through a serial port.

Configuration options: [COM1] [COM2]

Terminal Type [VT-UTF8]

Microsoft Windows Emergency Management Services (EMS) allow for remote management of a Windows Server OS through a serial port.

Configuration options: [VT100] [VT100+] [VT-UTF8] [ANSI]

Bits per second [115200]

Microsoft Windows Emergency Management Services (EMS) allow for remote management of a Windows Server OS through a serial port.

Configuration options: [9600] [19200] [57600] [115200]

Flow Control [None]

Microsoft Windows Emergency Management Services (EMS) allow for remote management of a Windows Server OS through a serial port.

Configuration options: [None] [Hardware RTS/CTS] [Software Xon/Xoff]

5.5.6 Onboard LAN Configuration

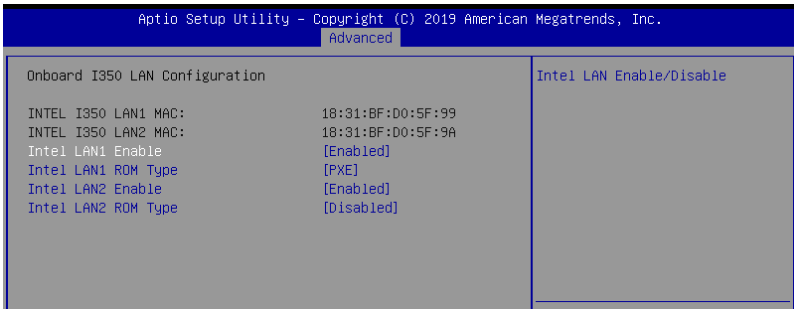

Onboard I350 LAN Configuration

Intel LAN1 Enable [Enabled]

Allows you to enable or disable the Intel LAN.

Configuration options: [Disabled] [Enabled]



The following items appear only when **Intel LAN1 Enable** is set to **[Enabled]**.

Intel LAN 1 ROM Type [PXE]

Allows you to select the Intel LAN ROM type.

Configuration options: [PXE] [iSCSI] [Disabled]

Intel LAN2 Enable [Enabled]

Allows you to enable or disable the Intel LAN.

Configuration options: [Disabled] [Enabled]



The following items appear only when **Intel LAN2 Enable** is set to **[Enabled]**.

Intel LAN 2 ROM Type [Disabled]

Allows you to select the Intel LAN ROM type.

Configuration options: [PXE] [iSCSI] [Disabled]

5.5.7 APM

Allows you to configure the Advance Power Management (APM) settings.

Aptio Setup Utility - Copyright (C) 2019 American Megatrends, Inc.		
Advanced		
Restore On AC Power Loss	[Last State]	Specify what state to go to when power is re-applied after a power failure (G3 state).
Power On By PCIE	[Disabled]	
Power On By RTC	[Disabled]	

Restore AC Power Loss [Last State]

When set to [Power Off], the system goes into off state after an AC power loss. When set to [Power On], the system will reboot after an AC power loss. When set to [Last State], the system goes into either off or on state, whatever the system state was before the AC power loss.

Configuration options: [Power Off] [Power On] [Last State]

Power On By PCIE [Disabled]

[Disabled] Disables the PCIE devices to generate a wake event.

[Enabled] Enables the PCIE devices to generate a wake event.

Power On By RTC [Disabled]

[Disabled] Disables RTC to generate a wake event.

[Enabled] When set to [Enabled], the items **RTC Alarm Date (Days)** and **Hour/Minute/Second** will become user-configurable with set values.

5.5.8 PCI Subsystem Settings

Allows you to configure PCI, PCI-X, and PCI Express Settings.

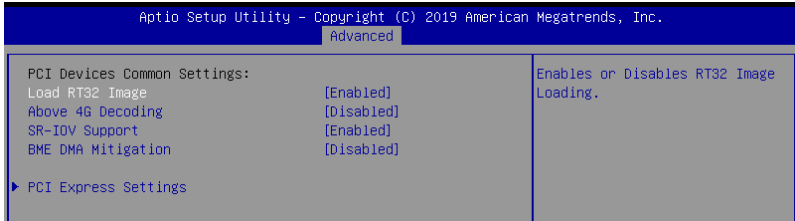

Load RT32 Image [Enabled]

This option allows you to enable or disable RT32 Image Loading.
Configuration options: [Disabled] [Enabled]

Above 4G Decoding [Disabled]

Allows you to enable or disable 64-bit capable devices to be decoded in above 4G address space. It only works if the system supports 64-bit PCI decoding.
Configuration options: [Disabled] [Enabled]

SR-IOV Support [Enabled]

This option enables or disables Single Root IO Virtualization Support if the system has SR-IOV capable PCIe devices.
Configuration options: [Disabled] [Enabled]

BME DMA Mitigation [Disabled]

This allows you to enable or disable re-enabling Bus Master Attribute disabled during PCI enumeration for PCI Bridges after SMM locked.
Configuration options: [Disabled] [Enabled]

PCI Express Settings

PCI Express Device Register Settings

Relaxed Ordering [Enabled]

Enables or disables PCI Express device relaxed ordering.
Configuration options: [Disabled] [Enabled]

Extended Tag [Disabled]

If Enable allows device is use 8-bit tag field as a requester.
Configuration options: [Disabled] [Enabled]

No Snoop [Enabled]

Enables or disables PCI Express device No snoop option.
Configuration options: [Disabled] [Enabled]

PCI Express Link Register Settings

ASPM Support [Disabled]

Allows to set the ASPM level. Configuration options: [Disabled] [Auto] [Force L0s]
[Force L0s] Force all links to L0s state.
[Auto] BIOS auto configure.
[Disabled] Disabled ASPM.

Unpopulated Links [Keep Link ON]

In order to save power, software will disable unpopulated PCI Express links, if this option set to Disabled.

Configuration options: [Keep Link ON] [Disabled]

PCIe OPROM Slot Options

PCIe1-3 Slot OPROM [Enabled]

This option allows you to enable or disable the OPROM of the PCIe slots.

Configuration options: [Disabled] [Enabled]

MEZZ1 Slot OPROM [Enabled]

This option allows you to enable or disable the OPROM of the MEZZ slot.

Configuration options: [Disabled] [Enabled]

5.5.9 USB Configuration

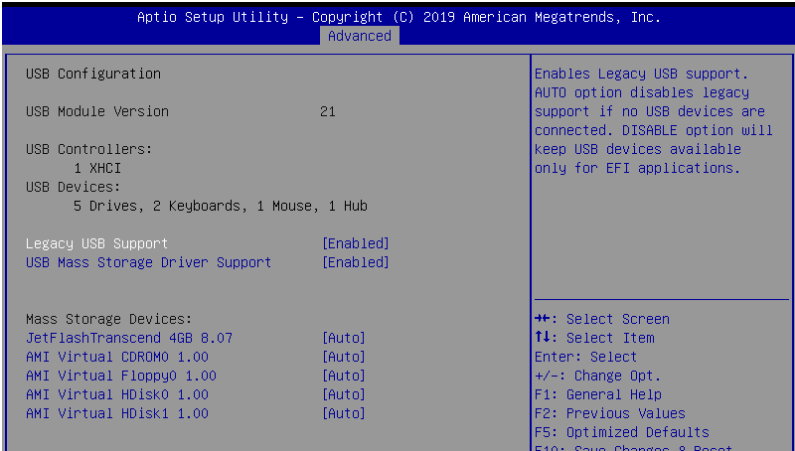

Legacy USB Support [Enabled]

Allows you to enable or disable Legacy USB device support.
 Configuration options: [Enabled] [Disabled] [Auto]

USB Mass Storage Driver Support [Enabled]

Allows you to enable or disable the USB Mass Storage driver support.
 Configuration options: [Disabled] [Enabled]

Mass Storage Devices

AMI Virtual CDROM0-2 / Floppy / HDisk0 1.00 [Auto]

Allows you to select the mass storage device emulation type.
 Configuration options: [Auto] [Floppy] [Forced FDD] [Hard Disk] [CD-ROM]

5.5.10 CSM Configuration

Aptio Setup Utility - Copyright (C) 2019 American Megatrends, Inc.	
Advanced	
Compatibility Support Module Configuration	
Enable/Disable CSM Support.	
CSM Support	[Enabled]
CSM16 Module Version	07.82
GateA20 Active	[Upon Request]
Option ROM Messages	[Force BIOS]
INT19 Trap Response	[Immediate]
Boot option filter	[Legacy only]
Option ROM execution	
Network	[Legacy]
Storage	[Legacy]
Video	[Legacy]
Other PCI devices	[Legacy]
*+: Select Screen	
F1: Select Item	
Enter: Select	
+/-: Change Opt.	
F1: General Help	
F2: Previous Values	

CSM Support [Enabled]

This option allows you to enable or disable CSM Support.
Configuration options: [Disabled] [Enabled]



The following item appears only when **CSM Support** is set to **[Enabled]**.

GateA20 Active [Upon Request]

This allows you to set the GA20 option.
Configuration options: [Upon Request] [Always]

Option ROM Messages [Force BIOS]

This allows you to set the display mode for option ROM.
Configuration options: [Force BIOS] [Keep Current]

INT19 Trap Response [Immediate]

[Immediate] Execute the trap right away.
[Postponed] Execute the trap during legacy boot.

Boot Option filter [Legacy only]

This option allows you to control the Legacy/UEFI ROMs priority.
Configuration options: [UEFI and Legacy] [Legacy only] [UEFI only]

Network / Storage / Video [Legacy]

This option allows you to control the execution of UEFI and Legacy PXE / Storage / Video OpROM.
Configuration options: [UEFI] [Legacy]

Other PCI devices [Legacy]

This item determines the OpROM execution policy for devices other than Network, Storage, or Video.
Configuration options: [UEFI] [Legacy]

5.5.11 NVMe Configuration

This page will display the NVMe controller and drive information.

Aptio Setup Utility - Copyright (C) 2019 American Megatrends, Inc.	
Advanced	
NVMe controller and Drive information	
No NVMe Device Found	

5.5.12 Network Stack Configuration

Aptio Setup Utility - Copyright (C) 2019 American Megatrends, Inc.	
Advanced	
Network Stack	[Disabled]
	Enable/Disable UEFI Network Stack

Network stack [Disabled]

Enables or disables the network stack feature.

Configuration options: [Disable] [Enable]



The following item appears only when **Network stack** is set to **[Enabled]**.

Ipv4 PXE Support [Disabled]

Enables or disables the Ipv4 PXE Boot Support. If disabled, Ipv4 PXE boot option will not be created.

Configuration options: [Disabled] [Enabled]

Ipv4 HTTP Support [Disabled]

Enables or disables the Ipv4 HTTP Boot Support. If disabled, Ipv4 HTTP boot option will not be created.

Configuration options: [Disabled] [Enabled]

Ipv6 PXE Support [Disabled]

Enables or disables the Ipv6 PXE Boot Support. If disabled, Ipv6 PXE boot option will not be created.

Configuration options: [Disabled] [Enabled]

Ipv6 HTTP Support [Disabled]

Enables or disables the Ipv6 HTTP Boot Support. If disabled, Ipv6 HTTP boot option will not be created.

Configuration options: [Disabled] [Enabled]

PXE boot wait time [0]

Wait time to press ESC key to abort the PXE boot.

Media detect time [1]

Wait time (in seconds) to detect media.

5.5.13 iSCSI Configuration

Allows you to configure the iSCSi parameters.

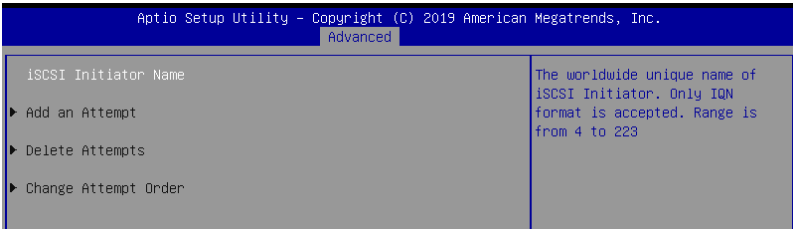

5.6 Platform Configuration menu

The IntelRCSetup menu items allow you to change the platform settings.

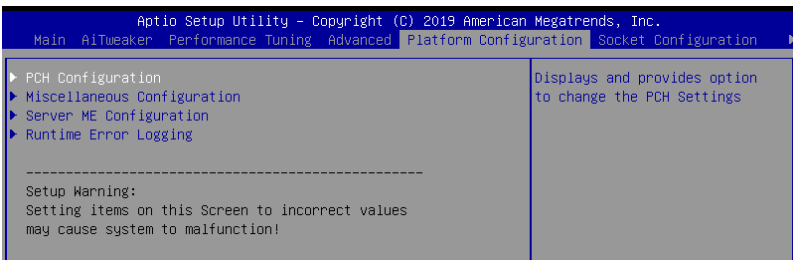

5.6.1 PCH Configuration

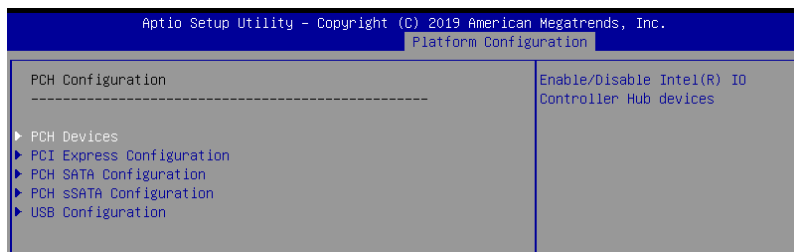

PCH Devices

DeepSx Power Policies [Disabled]

Allows you to configure the DeepSx Mode configuration.

Configuration options: [Disabled] [Enabled in S5] [Enabled in S4 and S5]

GP27 Wake From DeepSx [Disabled]

Allows you to enable or disable GP27 Wake From DeepSx.

Configuration options: [Disabled] [Enabled]

PCI Express Configuration

PCI-E ASPM Support (Global) [L1 Only]

Allows you to select ASPM support for all downstream devices.

Configuration options: [Per individual port] [L1 Only]

PCH DMI ASPM [Platform-POR]

Allows you to configure the PCH DMI ASPM.

Configuration options: [Platform-POR] [ASPM L1] [Disabled]

PCH SATA Configuration

SATA Controller [Enabled]

Allows you to enable or disable the SATA Controller.

Configuration options: [Disabled] [Enabled]

Configure sSATA as [AHCI]

Allows you to identify the SATA port connected to Solid State Drive or Hard Disk Drive.

Configuration options: [IDE] [AHCI] [RAID]

Support Aggressive Link Power Management [Enabled]

Allows you to enable or disable the Support Aggressive Link Power (SALP) Management.

Configuration options: [Disabled] [Enabled]

SATA Port 1-8

Port 1-8

Allows you to enable or disable the SATA port.
Configuration options: [Disabled] [Enabled]

PCH sSATA Configuration

sSATA Controller [Enabled]

Allows you to enable or disable the sSATA Controller.
Configuration options: [Disabled] [Enabled]

Configure sSATA as [AHCI]

Allows you to identify the SATA port connected to Solid State Drive or Hard Disk Drive.
Configuration options: [IDE] [AHCI] [RAID]

Support Aggressive Link Power Management [Enabled]

Allows you to enable or disable the Support Aggressive Link Power (SALP) Management.
Configuration options: [Disabled] [Enabled]

sSATA Port 1-3

Port 1-3

Allows you to enable or disable the SATA port.
Configuration options: [Disabled] [Enabled]

USB Configuration

USB Precondition [Disabled]

Allows you to enable or disable precondition work on USB host controller and root ports for faster enumeration.
Configuration options: [Disabled] [Enabled]

XHCI Manual Mode [Disabled]

This option is used by validation.
Configuration options: [Disabled] [Enabled]



The following items appears only when the **XHCI Manual Mode** is set to **[Enabled]**.

Trunk Clock Gating (BTCG) [Enabled]

Allows you to enable or disable BTCG.
Configuration options: [Disabled] [Enabled]

Enable USB 3.0 pins [Disable all pins]

Allows you to enable or disable USB 3.0 pins or on a per pin basis.
Configuration options: [Select Per-Pin] [Disable all pins] [Enable all pins]

USB Per-Connector Disable [Disabled]

Allows you to enable or disable each of the USB physical connectors. Once a connector is disabled, any USB devices plugged into the connector will not be detected by BIOS or OS.
Configuration options: [Disabled] [Enabled]



The following items appears only when the **USB Per-Connector Disable** is set to **[Enabled]**.

USB_1-8 [Enabled]

Configuration options: [Disabled] [Enabled]

USB3_1-5 [Enabled]

Configuration options: [Disabled] [Enabled]

Security Configuration

SMM BIOS Write Protect [Enabled]

Allows you to enable or disable SMM BIOS Write Protect.

Configuration options: [Disabled] [Enabled]

5.6.2 Miscellaneous Configuration

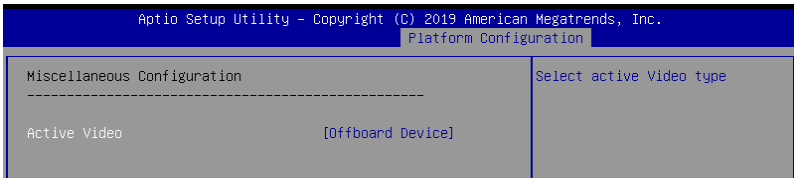

Active Video [Offboard Device]

Allows you to select the video type.

Configuration options: [Auto] [Onboard Device] [Offboard Device]

5.6.3 Server ME Configuration

Displays the Server ME Technology parameters on your system.

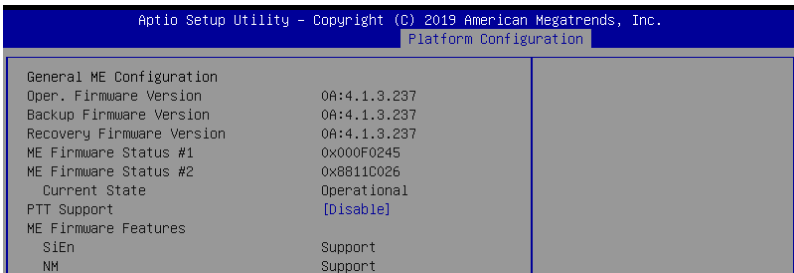

5.6.4 Runtime Error Logging Support

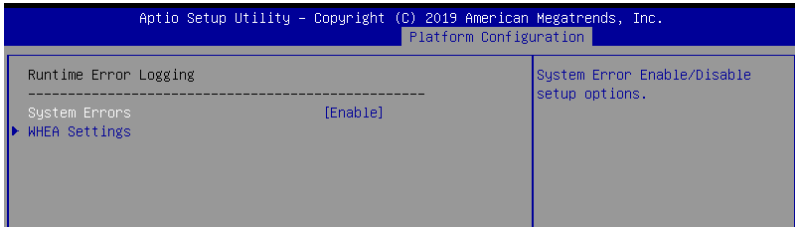

Runtime Error Logging

System Errors [Enabled]

This item allows you to enable or disable System Errors.

Configuration options: [Disabled] [Enabled]

Whea Settings

Whea Support [Disabled]

This item allows you to enable or disable the WHEA support.

Configuration options: [Disabled] [Enabled]

5.7 Socket Configuration menu

The IntelRCSetup menu items allow you to change the socket settings.

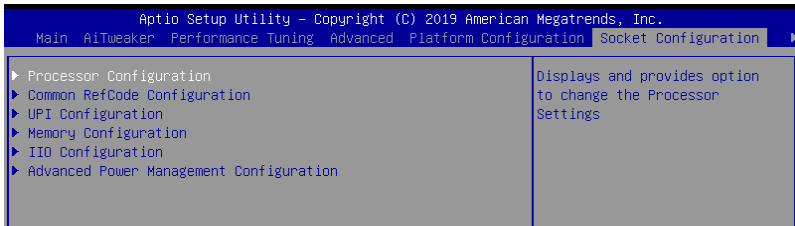

5.7.1 Processor Configuration

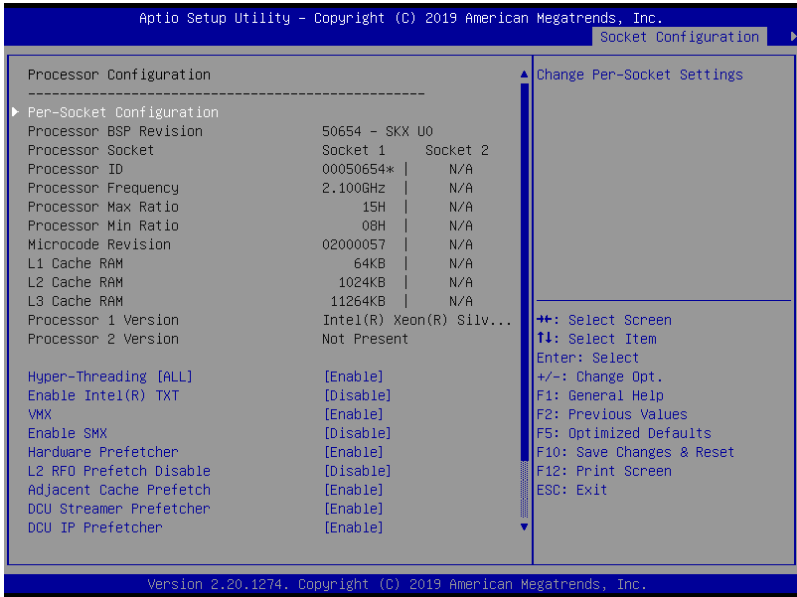

Hyper Threading [ALL] [Enabled]

Allows you to enable or disable the Hyper-Threading Technology function. When disabled, only one thread per activated core is enabled.

Configuration options: [Disabled] [Enabled]

Enable Intel(R) TXT Support [Disabled]

Forces the XD feature log to always return 0 when disabled.

Configuration options: [Disabled] [Enabled]

VMX [Enabled]

Enables the Vanderpool Technology. Takes effect after reboot.

Configuration options: [Disabled] [Enabled]

Enable SMX [Disabled]

Enables the Safer Mode Extensions.

Configuration options: [Disabled] [Enabled]

Hardware Prefetcher [Enabled]

This Item allows you to turn on/off the mid level cache(L2) streamer prefetcher.

Configuration options: [Disabled] [Enabled]

L2 RFO Prefetch Disable [Disabled]

This Item allows you to turn on/off L2 RFO prefetcher.

Configuration options: [Disabled] [Enabled]

Adjacent Cache Prefetch [Enabled]

This Item allows you to turn on/off prefetching of adjacent cache lines.
Configuration options: [Disabled] [Enabled]

DCU Streamer Prefetcher [Enabled]

This Item allows you to enable or disable prefetcher of next L1 data line.
Configuration options: [Disabled] [Enabled]

DCU IP Prefetcher [Enabled]

This Item allows you to enable or disable prefetch of next L1 line based upon sequential load history.
Configuration options: [Disabled] [Enabled]

LLC Prefetch [Disabled]

This Item allows you to enable or disable LLC Prefetch on all threads.
Configuration options: [Disabled] [Enabled]

DCU Mode [32K 8Way Without ECC]

Configuration options: [32K 8Way Without ECC] [16K 4Way With ECC]

Extended APIC [Disabled]

This Item allows you to enable or disable the extended APIC support.
Configuration options: [Disabled] [Enabled]

AES-NI [Enabled]

This Item allows you to enable or disable the AES-NI support.
Configuration options: [Disabled] [Enabled]

5.7.2 Common RefCode Configuration

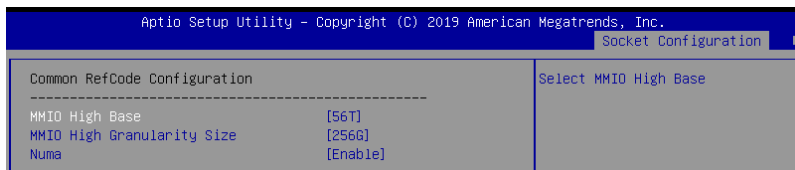

MMIO High Base [56T]

This item allows you to select the MMIO High Base.
Configuration options: [56T] [40T] [24T] [16T] [4T] [1T]

MMIO High Granularity Size [256G]

This item allows you to select the allocation size used to assign MMIOH resources.
Configuration options: [1G] [4G] [16G] [64G] [256G] [1024G]

Numa [Enabled]

This item enables or disables the Non uniform Memory Access (NUMA).
Configuration options: [Disabled] [Enabled]

5.7.3 UPI Configuration

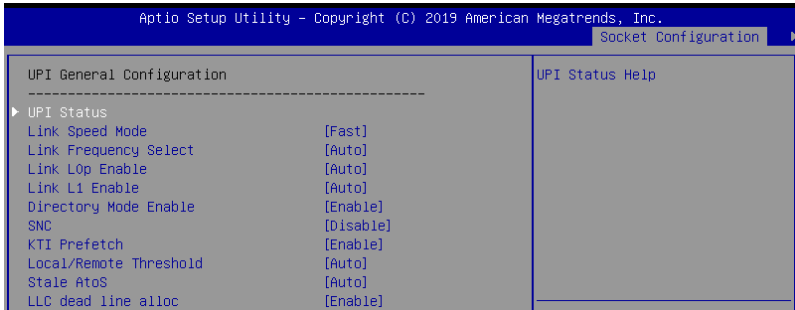

UPI General Configuration

UPI Status

This item displays information about the UPI status.

Link Speed Mode [Fast]

This item allows you to select the UPI link speed as either the fast mode or slow mode.

Configuration options: [Slow] [Fast]

Link Frequency Select [Auto]

This item allows for selecting the UPI link frequency.

Configuration options: [Auto] [9.6 GB/s] [10.4 GB/s] [Use Per Link Setting]

UPI Link0p Enable [Enabled]

Configuration options: [Disabled] [Enabled] [Auto]

UPI Link1 Enable [Enabled]

Configuration options: [Disabled] [Enabled] [Auto]

Directory Mode Enable [Enabled]

Configuration options: [Disabled] [Enabled]

SNC [Disabled]

Configuration options: [Disabled] [Enabled] [Auto]

KTI Prefetch [Enabled]

Configuration options: [Disabled] [Enabled]

Local/Remote Threshold [Auto]

Configuration options: [Disabled] [Auto] [Low] [Medium] [High]

Stale AtoS [Disabled]

Configuration options: [Disabled] [Enabled] [Auto]

LLC dead line alloc [Enabled]

Configuration options: [Disabled] [Enabled] [Auto]

5.7.4 Memory Configuration

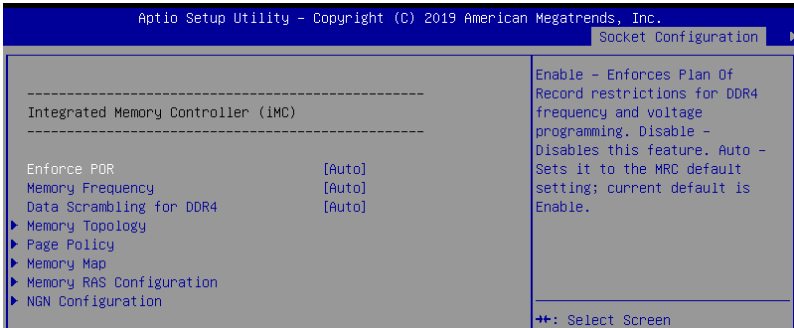

Enforce POR [Auto]

Allows you to enforce POR restrictions for DDR4 frequency and voltage programming.
Configuration options: [Auto] [POR] [Disabled]

Memory Frequency [Auto]

Allows you to select the memory frequency setting.
Configuration options: [Auto] [1800] - [3000-OvrClk]

Data Scrambling for DDR4 [Auto]

Allows you to enable or disable data scrambling.
Configuration options: [Auto] [Disabled] [Enabled]

Memory Topology

Displays memory topology with DIMM population information.

Page Policy

Allows you to configure Page Policy settings.

Page Policy [Disabled]

Configuration options: [Auto] [Closed] [Adaptive]

Memory Map

IMC Interleaving [Auto]

Select different IMC interleaving setting.
Configuration options: [Auto] [1-way Interleave] [2-way Interleave]

Channel Interleaving [Auto]

Select different channel interleaving setting.
Configuration options: [Auto] [1-way Interleave] [2-way Interleave] [3-way Interleave]

Rank Interleaving [Auto]

Select different rank interleaving setting.

Configuration options: [Auto] [1-way Interleave] [2-way Interleave]
[4-way Interleave] [8-way Interleave]

Memory RAS Configuration

Mirror Mode [Disabled]

Allows you to select Mirror Modes. Mirror Mode will set entire 1LM/2LM memory in system to be mirrored, consequently reducing the memory capacity by half. Enabling Mirror Mode will disable XPT Prefetch.

Configuration options: [Disabled] [Mirror Mode 1LM] [Mirror Mode 2LM]

UEFI ARM Mirror [Disabled]

Allows you to enable or disable UEFI ARM Mirror.

Configuration options: [Disabled] [Enabled]

Memory Rank Sparing [Disabled]

Allows you to enable or disable Memory Rank Sparing

Configuration options: [Disabled] [Enabled]

Patrol Scrub [Enabled]

Allows you to enable or disable Patrol Scrub.

Configuration options: [Disabled] [Enabled]

NGN Configuration

Average Power Budget (in mW) [18000]

Allows you to set the power management policy for average power in 250 mW increments.

Configuration options: [10000] - [18000]

5.7.5 IIO Configuration

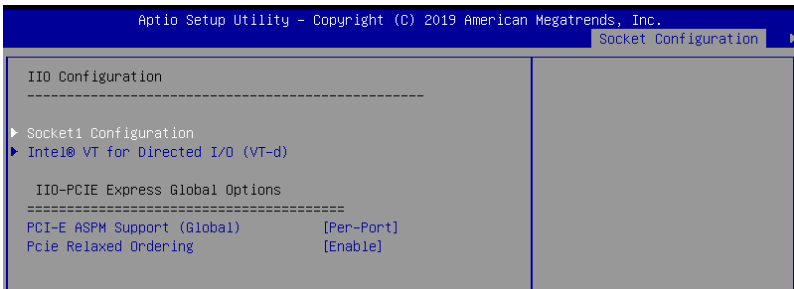

Socket1 Configuration

This item allows you to configure settings related to the corresponding PCIe port.

Intel(R) VT for Directed I/O (VT-d)

Intel(R) VT for Directed I/O (VT-d) [Disabled]

Allows you to enable or disable the Intel Virtualization Technology for Directed I/O.

Configuration options: [Disabled] [Enabled]

PCI Express Global Options

PCI-E ASPM Support (Global) [Per-Port]

Allows you to enable or disable ASPM support for all downstream devices.

Configuration options: [Disabled] [Per-Port] [L1 Only]

PCIe relaxed Ordering [Enabled]

Allows you to enable or disable PCIe relaxed Ordering.

Configuration options: [Disabled] [Enabled]

5.7.6 Advanced Power Management Configuration

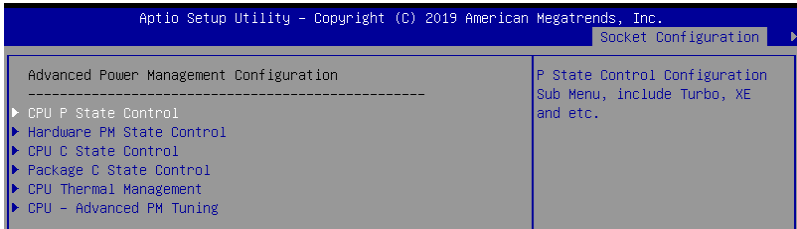

CPU P State Control

Boot performance mode [Max Performance]

Allows you to switch between Boot performance mode.

Configuration options: [Max Performance] [Max Efficient] [Set by Intel Node Manager]

Energy Efficient Turbo [Enabled]

Allows you to enable or disable Energy Efficient Turbo.

Configuration options: [Disabled] [Enabled]

Turbo Mode [Enabled]

Allows you to enable or disable Turbo Mode.

Configuration options: [Disabled] [Enabled]

Hardware PM State Control

Hardware P-States [Native Mode]

Allows you to switch between Hardware P-States mode.

Configuration options: [Disabled] [Native Mode] [Out of Band Mode] [Native Mode with no Legacy Support]

CPU C State Control

Autonomous Core C-State [Disabled]

Allows you to enable or disable Autonomous Core C-State Report.

Configuration options: [Disabled] [Enabled]

CPU C6 Report [Auto]

Allows you to select CPU C6 Report.

Configuration options: [Disabled] [Enabled] [Auto]

OS ACPI Cx [ACPI C2]

Allows you to select OS ACPI Cx Report.

Configuration options: [ACPI C2] [ACPI C3]

Package C State Control

Package C State [Auto]

Allows you to select Package C State.

Configuration options: [C0/C1 state] [C2 state] [C6(non Retention state)] [C6(Retention state)] [No Limit] [Auto]

CPU Thermal Control

CPU T-State Control

Software Controlled T-States [Disabled]

Allows you to enable or disable Software Controlled T-States.

Configuration options: [Disabled] [Enabled]

CPU - Advanced PM Tuning

Energy Perf BIAS

Power Performance Tuning [OS Controls EPB]

Configuration options: [OS Controls EPB] [BIOS Controls EPB]



The following item appears only when you set **Power Performance Tuning** to **[OS Controls EPB]**.

PECI PCS EPB [OS Controls EPB]

This option controls whether Peci has control over EPB.

Configuration options: [OS Controls EPB] [PECI Controls EPB using PCS]



The following item appears only when you set **Power Performance Tuning** to **[BIOS Controls EPB]**.

ENERGY_PERF_BIAS_CFG Mode [Balanced Performance]

Configuration options: [Performance] [Balanced Performance] [Balanced Power] [Power]

Dynamic Loadline Switch [Enabled]

Configuration options: [Disabled] [Enabled]

Workload Configuration [UMA]

This option allows optimization for the workload characterization.

Configuration options: [UMA] [NUMA]

Averaging Time Window [17]

This option is used to control the effective window of the average C0 an P0 time.

Configuration options: [0] - [FF]

P0 TotalTimeThreshold Low [23]

The HW switching mechanism DISABLES the performance setting (0) when the total P0 time is less than the threshold set.

Configuration options: [0] - [3F]

P0 TotalTimeThreshold High [3a]

The HW switching mechanism Enables the performance setting (0) when the total P0 time is greater than the threshold set.

Configuration options: [0] - [3F]

5.8 Event Logs menu

The Event Logs menu items allow you to change the event log settings and view the system event logs.

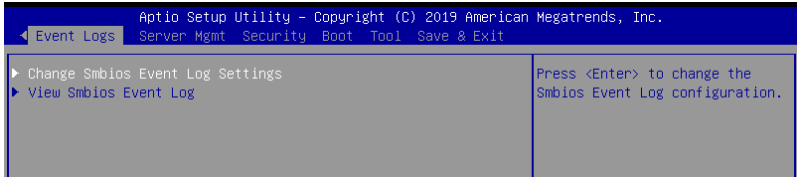

5.8.1 Change Smbios Event Log Settings

Press <Enter> to change the Smbios Event Log configuration.



All values changed here do not take effect until computer is restarted.

Enabling/Disabling Options

Smbios Event Log [Enabled]

Change this to enable or disable all features of Smbios Event Logging during boot.
Configuration options: [Disabled] [Enabled]

Erasing Settings

Erase Event Log [No]

Choose options for erasing Smbios Event Log. Erasing is done prior to any logging activation during reset.
Configuration options: [No] [Yes, Next reset] [Yes, Every reset]

5.8.2 View Smbios Event Log

Press <Enter> to view all smbios event logs.

5.9 Server Mgmt menu

The Server Management menu displays the server management status and allows you to change the settings.

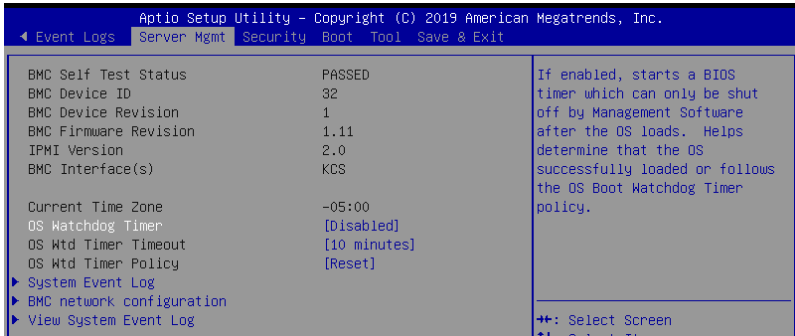

OS Watchdog Timer [Disabled]

This item allows you to start a BIOS timer which can only be shut off by Intel Management Software after the OS loads.

Configuration options: [Disabled] [Enabled]



The following items is configurable only when the **OS Watchdog Timer** is set to **[Enabled]**.

OS Wtd Timer Timeout [10 minutes]

Allows you to configure the length fo the OS Boot Watchdog Timer.

Configuration options: [5 minutes] [10 minutes] [15 minutes] [20 minutes]

OS Wtd Timer Policy [Reset]

This item allows you to configure the how the system should respond if the OS Boot Watch Timer expires.

Configuration options: [Do Nothing] [Reset] [Power Down]

System Event Log

Allows you to change the SEL event log configuration.

Erase SEL [No]

Allows you to choose options for erasing SEL.

Configuration options: [No] [Yes, On next reset] [Yes, On every reset]

When SEL is Full [Do Nothing]

Allows you to choose options for reactions to a full SEL.

Configuration options: [Do Nothing] [Erase Immediately]

BMC network configuration

The sub-items in this configuration allow you to configure the BMC network parameters.

View System Event Log

This item allows you to view the system event log records.

5.10 Security menu

This menu allows a new password to be created or a current password to be changed. The menu also enables or disables the Secure Boot state and lets the user configure the System Mode state.

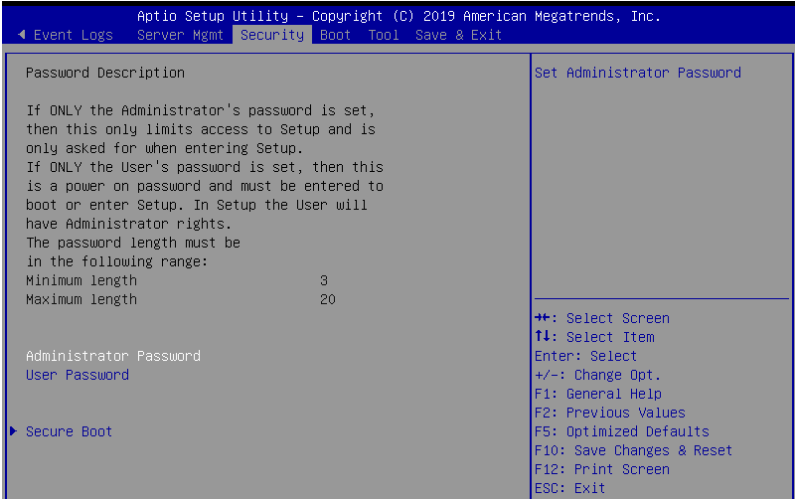

Administrator Password

To set an administrator password:

1. Select the Administrator Password item and press <Enter>.
2. From the Create New Password box, key in a password, then press <Enter>.
3. Confirm the password when prompted.

To change an administrator password:

1. Select the Administrator Password item and press <Enter>.
2. From the Enter Current Password box, key in the current password, then press <Enter>.
3. From the Create New Password box, key in a new password, then press <Enter>.
4. Confirm the password when prompted.



To clear the administrator password, follow the same steps as in changing an administrator password, but press <Enter> when prompted to create/confirm the password.

User Password

To set a user password:

1. Select the User Password item and press <Enter>.
2. From the Create New Password box, key in a password, then press <Enter>.
3. Confirm the password when prompted.

To change a user password:

1. Select the User Password item and press <Enter>.
2. From the Enter Current Password box, key in the current password, then press <Enter>.
3. From the Create New Password box, key in a new password, then press <Enter>.
4. Confirm the password when prompted.

To clear a user password:

1. Select the Clear User Password item and press <Enter>.
2. Select Yes from the Warning message window then press <Enter>.

Secure Boot

This item allows you to customize the Secure Boot settings.



Attempt Secure Boot [Disabled]

Secure Boot can be enabled if the system is running in User mode with enrolled platform Key (EPK) or if the CSM function is disabled.

Configuration options: [Disabled] [Enabled]

Secure Boot Mode [Custom]

Allows you to set the Secure Boot selector.

Configuration options: [Custom] [Standard]

Key Management

This item only appears when the item Secure Boot Mode is set to [Custom]. The Key Management item allows you to modify Secure Boot variables and set Key Management page.

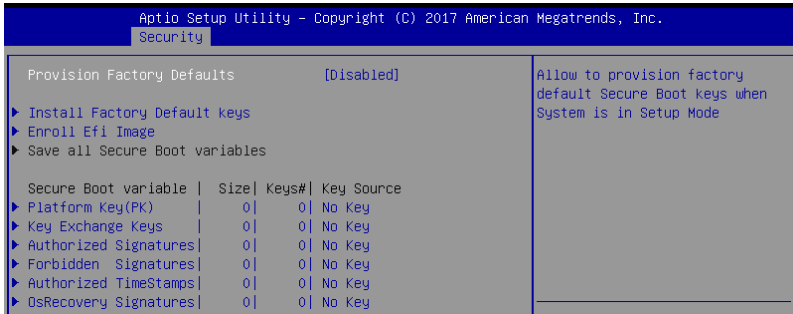

Provision Factory Defaults [Disabled]

Allows you to provision factory default Secure Boot keys when the system is in Setup Mode.

Configuration options: [Disabled] [Enabled]

Install Factory Default keys

This item will install all Factory Default keys.

Reset to Setup Mode

This item appears only when you load the default Secure Boot keys. This item allows you to clear all default Secure Boot keys.

Enroll Efi Image

This item will allow the image to run in Secure Boot mode.

Save All Secure Boot Variables

This item will ask you if you want to save all secure boot variables. Select Yes if you want to save all secure boot variables, otherwise select No.

Platform Key (PK)

Configuration options: [Save to File] [Set New] [Erase]

Key Exchange Keys / Authorized Signatures / Forbidden Signatures

Configuration options: [Save to File] [Set New] [Append] [Erase]

Authorized TimeStamps

Configuration options: [Set New] [Append]

OsRecovery Signatures

Configuration options: [Set New] [Append]

5.11 Boot menu

The Boot menu items allow you to change the system boot options.

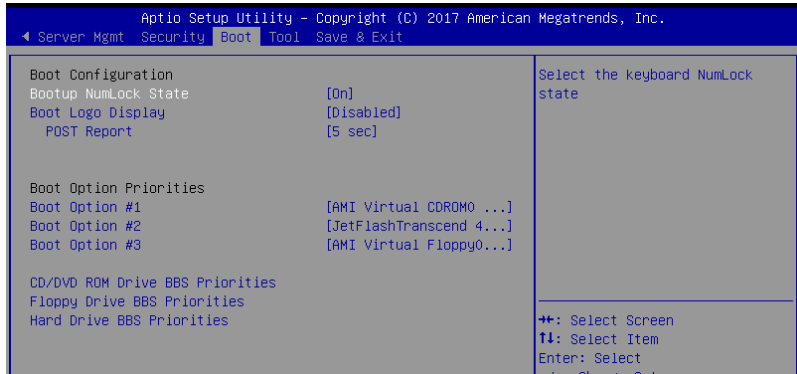

Bootup NumLock State [On]

Allows you to select the power-on state for the NumLock.

Configuration options: [Off] [On]

Boot Logo Display [Disabled]

Allows you to enable or disable the full screen logo display feature.

Configuration options: [Auto] [Full Screen] [Disabled]



The following item appears only when you set the **Boot Logo Display** to **[Disabled]**.

POST Report [5 sec]

Allows you to set the desired POST Report waiting time from 1 to 10 seconds.

Configuration options: [1 sec] ~ [10 sec] [Until Press ESC]

Boot Option Priorities

These items specify the boot device priority sequence from the available devices. The number of device items that appears on the screen depends on the number of devices installed in the system.



- To select the boot device during system startup, press <F8> when ASUS Logo appears.
- To access Windows OS in Safe Mode, please press <F8> after POST.

Hard Drive / CD/DVD ROM / Floppy Drive / BBS Priorities

These items appear only when you connect SATA ODD or hard drive to the SATA ports and allow you to set the booting order of the SATA devices.

5.12 Tool menu

The Tool menu items allow you to configure options for special functions. Select an item then press <Enter> to display the submenu.



IPMI Hardware Monitor

Allows you to run the IPMI hardware monitor.

Start EzFlash

Allows you to run ASUS EzFlash BIOS ROM Utility when you press <Enter>. Refer to the ASUS EzFlash Utility section for details.

5.13 Save & Exit menu

The Exit menu items allow you to save or discard your changes to the BIOS items.



Pressing <Esc> does not immediately exit this menu. Select one of the options from this menu or <F10> from the legend bar to exit.

Discard Changes and Exit

Exit System setup without saving any changes.

Save Changes and Reset

Exit System setup after saving the changes.

Restore Defaults

Restore/load default values for all the setup options.

Boot Override

These items displays the available devices. The device items that appears on the screen depends on the number of devices installed in the system. Select an item to start booting from the selected device.

Launch EFI Shell from filesystem device

This item allows you to attempt to launch the EFI Shell application (shellx64.efi) from one of the available filesystem devices.

RAID Configuration

6

This chapter provides instructions for setting up, creating, and configuring RAID sets using the available utilities.

6.1 Setting up RAID

The motherboard supports the Intel® Rapid Storage Technology enterprise Option ROM Utility with RAID 0, RAID 1, RAID 10, and RAID 5 support.

6.1.1 RAID definitions

RAID 0 (Data striping) optimizes two identical hard disk drives to read and write data in parallel, interleaved stacks. Two hard disks perform the same work as a single drive but at a sustained data transfer rate, double that of a single disk alone, thus improving data access and storage. Use of two new identical hard disk drives is required for this setup.

RAID 1 (Data mirroring) copies and maintains an identical image of data from one drive to a second drive. If one drive fails, the disk array management software directs all applications to the surviving drive as it contains a complete copy of the data in the other drive. This RAID configuration provides data protection and increases fault tolerance to the entire system. Use two new drives or use an existing drive and a new drive for this setup. The new drive must be of the same size or larger than the existing drive.

RAID 10 is data striping and data mirroring combined without parity (redundancy data) having to be calculated and written. With the RAID 10 configuration you get all the benefits of both RAID 0 and RAID 1 configurations. Use four new hard disk drives or use an existing drive and three new drives for this setup.

RAID 5 stripes both data and parity information across three or more hard disk drives. Among the advantages of RAID 5 configuration include better HDD performance, fault tolerance, and higher storage capacity. The RAID 5 configuration is best suited for transaction processing, relational database applications, enterprise resource planning, and other business systems. Use a minimum of three identical hard disk drives for this setup.



If you want to boot the system from a hard disk drive included in a created RAID set, copy first the RAID driver from the support DVD to a floppy disk before you install an operating system to the selected hard disk drive.

6.1.2 Installing hard disk drives

The motherboard supports Serial ATA for RAID set configuration. For optimal performance, install identical drives of the same model and capacity when creating a disk array.

To install the SATA hard disks for RAID configuration:

1. Install the SATA hard disks into the drive bays following the instructions in the system user guide.
2. Connect a SATA signal cable to the signal connector at the back of each drive and to the SATA connector on the motherboard.
3. Connect a SATA power cable to the power connector on each drive.

6.1.3 Setting the RAID item in BIOS

You must set the RAID item in the BIOS Setup before you can create a RAID set from SATA hard disk drives attached to the SATA connectors supported by Intel® C621 chipset.

To do this:

1. Enter the BIOS Setup during POST.
2. Go to the **Platform Configuration menu** Menu > **PCH Configuration** Menu > **PCH SATA Configuration**, then press <Enter>.
3. Set **Configure sSATA as** to [RAID Mode]
4. Press <F10> to save your changes and exit the BIOS Setup.



Refer to Chapter 5 for details on entering and navigating through the BIOS Setup.

6.1.4 RAID configuration utilities

Depending on the RAID connectors that you use, you can create a RAID set using the utilities embedded in each RAID controller. For example, use the **Intel® Rapid Storage Technology** if you installed Serial ATA hard disk drives on the Serial ATA connectors supported by the Intel® C621 chipset.

Refer to the succeeding section for details on how to use the RAID configuration utility.

6.2 Intel® Rapid Storage Technology enterprise SATA Option ROM Utility

The Intel® Rapid Storage Technology enterprise SATA Option ROM utility allows you to create RAID 0, RAID 1, RAID 10 (RAID 1+0), and RAID 5 set from Serial ATA hard disk drives that are connected to the Serial ATA connectors supported by the Southbridge.



Before you proceed, ensure that you have installed the Serial ATA hard disk drives, and have set the correct SATA mode in the BIOS setup.

To launch the Intel® Rapid Storage Technology enterprise SATA Option ROM utility:

1. Turn on the system.
2. During POST, press <Ctrl>+<I> to display the utility main menu.

```
Intel(R) Rapid Storage Technology enterprise - SATA Option ROM - 3.6.0.1023
Copyright(C) 2003-12 Intel Corporation. All Rights Reserved.

----- [ MAIN MENU ] -----
  1. Create RAID Volume          3. Reset Disks to Non-RAID
  2. Delete RAID Volume        4. Exit

----- [ DISK/VOLUME INFORMATION ] -----

RAID Volumes:
None defined.

Physical Disks:
ID Drive Model      Serial #           Size   Type/Status (Vol ID)
0  ST3300656SS      HWA50000991753TR 279.3GB Non-RAID Disk
1  ST3300656SS      37VN00009846RAJ1 279.3GB Non-RAID Disk
2  ST3300656SS      397600009846UEDY 279.3GB Non-RAID Disk
3  ST3300656SS      GWC50000991756G6 279.3GB Non-RAID Disk

[↑↓]-Select      [ESC]-Exit      [ENTER]-Select Menu
```

The navigation keys at the bottom of the screen allow you to move through the menus and select the menu options.



The RAID BIOS setup screens shown in this section are for reference only and may not exactly match the items on your screen.

6.2.1 Creating a RAID set

To create a RAID set:

1. From the utility main menu, select **1. Create RAID Volume** and press <Enter>.
2. Key in a name for the RAID set and press <Enter>.

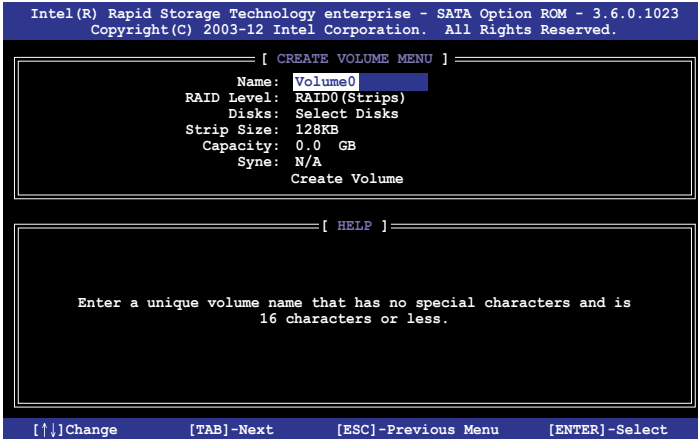

3. Press the up/down arrow keys to select a RAID Level that you wish to create then press <Enter>.
4. From the **Disks** item field, press <Enter> to select the hard disk drives that you want to include in the RAID set.

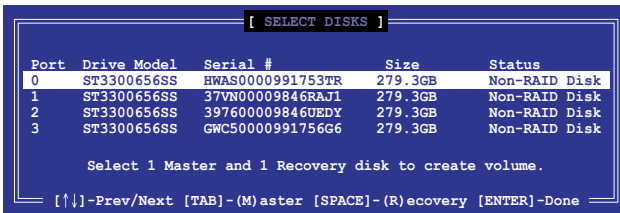

5. Use the up/down arrow keys to move the selection bar then press <Space> to select a disk. A small triangle before the Port number marks the selected drive. Press <Enter> when you are done.

6. Use the up/down arrow keys to select the stripe size for the RAID array (for RAID 0, 10 and 5 only) then press <Enter>. The available stripe size values range from 4 KB to 128 KB. The following are typical values:
RAID 0: 128KB
RAID 10: 64KB
RAID 5: 64KB



We recommend a lower stripe size for server systems, and a higher stripe size for multimedia computer systems used mainly for audio and video editing.

7. In the **Capacity** field item, key in the RAID volume capacity that you want to use and press <Enter>. The default value field indicates the maximum allowed capacity.
8. Press <Enter> to start creating the RAID volume.
9. From the following warning message, press <Y> to create the RAID volume and return to the main menu, or press <N> to go back to the **CREATE VOLUME** menu.

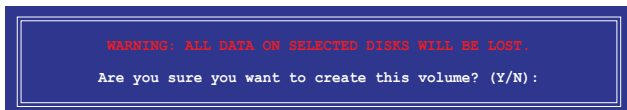

6.2.2 Deleting a RAID set



Take caution when deleting a RAID set. You will lose all data on the hard disk drives when you delete a RAID set.

To delete a RAID set:

1. From the utility main menu, select **2. Delete RAID Volume** and press <Enter>.
2. From the Delete Volume Menu, press the up/down arrow keys to select the RAID set you want to delete then press .

```
Intel(R) Rapid Storage Technology enterprise - SATA Option ROM - 3.6.0.1023
Copyright(C) 2003-12 Intel Corporation. All Rights Reserved.

[ DELETE VOLUME MENU ]

Name      Level      Drives    Capacity  Status    Bootable
Volume0   RAID0 (Stripe)  2         298.0GB   Normal    Yes

[ HELP ]

Deleting a volume will reset the disks to non-RAID

WARNING: ALL DISK DATA WILL BE DELETED.
(This does not apply to Recovery volumes)

[↑↓]-Select      [ESC]-Previous Menu      [DEL]-Delete Volume
```

3. Press <Y> to confirm deletion of the selected RAID set and return to the utility main menu, or press <N> to return to the **DELETE VOLUME** menu.

```
[ DELETE VOLUME VERIFICATION ]

ALL DATA IN THE VOLUME WILL BE LOST!
(This does not apply to Recovery volumes)

Are you sure you want to delete volume "Volume0"? (Y/N):
```

6.2.3 Resetting disks to Non-RAID



Take caution before you reset a RAID volume hard disk drive to non-RAID. Resetting a RAID volume hard disk drive deletes all internal RAID structure on the drive.

To reset a RAID set:

1. From the utility main menu, select **3. Reset Disks to Non-RAID** and press <Enter>.
2. Press the up/down arrow keys to select the drive(s) or disks of the RAID set you want to reset, then press <Space>. A small triangle before the Port number marks the selected drive. Press <Enter> when you are done.

```
[ RESET RAID DATA ]
Resetting RAID disk will remove its RAID structures
and revert it to a non-RAID disk.

WARNING: Resetting a disk causes all data on the disk to be lost.
(This does not apply to Recovery volumes)

Port  Drive Model  Serial #          Size      Status
---  -
0     ST3300656SS    HWAS0000991753TR 279.3GB  Member Disk
1     ST3300656SS    37VN00009846RAJ1 279.3GB  Member Disk

Select the disks that should be reset.

[↑↓]-Previous/Next [SPACE]-Selects [ENTER]-Selection Complete
```

3. Press <Y> in the confirmation window to reset the drive(s) or press <N> to return to the utility main menu.

6.2.4 Exiting the Intel® Rapid Storage Technology enterprise SATA Option ROM utility

To exit the utility:

1. From the utility main menu, select **4. Exit** then press <Enter>.
2. Press <Y> to exit or press <N> to return to the utility main menu.

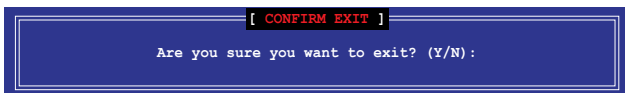

6.2.5 Rebuilding the RAID



This option is only for the RAID 1 set.

Rebuilding the RAID with other non-RAID disk

If any of the SATA hard disk drives included in the RAID 1 array failed, the system displays the status of the RAID volume as **"Degraded"** during POST. You can rebuild the RAID array with other installed non-RAID disks.

To rebuild the RAID with other non-RAID disk:

1. During POST, press <Ctrl>+<I> at the prompt to enter the Intel Rapid Storage Technology option ROM utility.
2. If there is a non-RAID SATA Hard Disk available, the utility will prompt you to rebuild the RAID. Press the up/down arrow keys to select the destination disk then Press <Enter> to start the rebuilding process, or press <ESC> to exit.

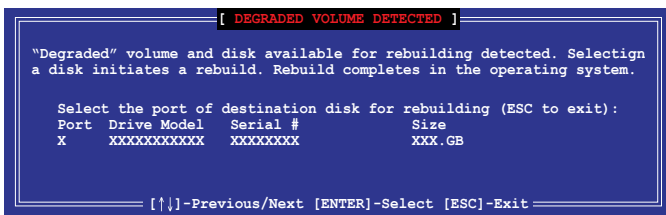

Select a destination disk with the same size as the original hard disk.

- The utility immediately starts rebuilding after the disk is selected. When done, the status of the degraded RAID volume is changed to **“Rebuild”**.

```

Intel(R) Rapid Storage Technology enterprise - SATA Option ROM - 3.6.0.1023
Copyright(C) 2003-12 Intel Corporation. All Rights Reserved.

----- [ MAIN MENU ] -----
1. Create RAID Volume          3. Reset Disks to Non-RAID
2. Delete RAID Volume         4. Exit

----- [ DISK/VOLUME INFORMATION ] -----

RAID Volumes:
ID  Name      Levell      Strip      Size      *=Data is Encrypted
1   Volume0   RAID1(Mirror)  N/A       149.0GB   Status  Bootable
                                     Rebuild Yes

Physical Devices:
Port  Drive Model  Serial #      Size      Type/Status (Vol ID)
1     ST3160812AS  9LS0F4HL     149.0GB   Member Disk(0)
2     ST3160812AS  3LS0JYL8     149.0GB   Member Disk(0)

Volumes with "Rebuild" status will be rebuilt within the operating system.

[↑↓]-Select      [ESC]-Exit      [ENTER]-Select Menu

```

- Press <Esc> to exit Intel Rapid Storage Technology and reboot the system.
- Select **Start > Programs > Intel Rapid Storage > Intel Rapid Storage Console** or click the **Intel Rapid Storage Technology** tray icon to load the Intel Rapid Storage Manager utility.
- From the **View** menu, select **Advanced Mode** to display the details of the Intel Rapid Storage Console.
- From the **Volumes view** option, select **RAID volume** to view the rebuilding status. When finished, the status is changed to **“Normal”**.

Rebuilding the RAID with a new hard disk

If any of the SATA hard disk drives included in the RAID array failed, the system displays the status of the RAID volume as **“Degraded”** during POST. You may replace the disk drive and rebuild the RAID array.

To rebuild the RAID with a new hard disk:

- Remove the failed SATA hard disk and install a new SATA hard disk of the same specification into the same SATA Port.



Select a destination disk with the same size as the original hard disk.

- Reboot the system then follow the steps in section **Rebuilding the RAID with other non-RAID disk**.

6.2.6 Setting the Boot array in the BIOS Setup Utility

You can set the boot priority sequence in the BIOS for your RAID arrays when creating multi-RAID using the Intel® Rapid Storage Technology enterprise SATA Option ROM utility.

To set the boot array in the BIOS:



Set at least one of the arrays bootable to boot from the hard disk.

1. Reboot the system and press to enter the BIOS setup utility during POST.
2. Go to the **Boot** menu and select the boot option priority.
3. Use up/down arrow keys to select the boot priority and press <Enter>. See the **Boot menu** section of Chapter 5 for more details.
4. From the **Exit** menu, select **Save Changes & Exit**, then press <Enter>.
5. When the confirmation window appears, select **Yes**, then press <Enter>.

6.3 Intel® Rapid Storage Technology enterprise (Windows)

The Intel® Rapid Storage Technology enterprise allows you to create RAID 0, RAID 1, RAID 10 (RAID 1+0), and RAID 5 set(s) from Serial ATA hard disk drives that are connected to the Serial ATA connectors supported by the Southbridge.



You need to manually install the Intel® Rapid Storage Technology enterprise utility on a Windows® operating system. Please refer to the installation instructions in Chapter 7.

To enter the Intel® Rapid Storage Technology enterprise utility under Windows operating system:

1. Turn on the system and go to the windows desktop.
2. Click the **Intel® Rapid Storage Technology enterprise** icon to display the main menu.

Your storage system is configured for data protection, increased performance and optimal data storage capacity. You can create additional volumes to further optimize your storage system.

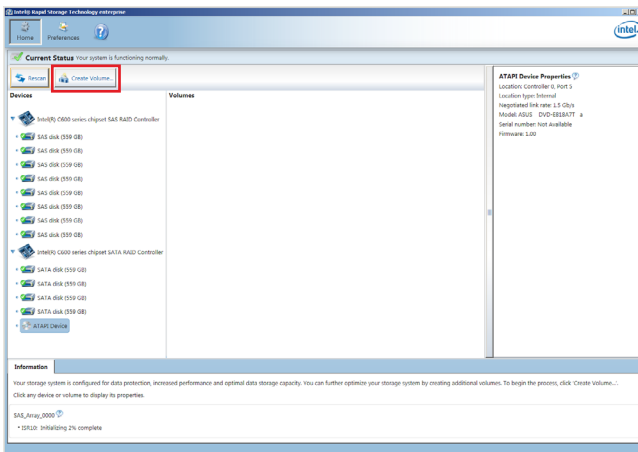

You can click **Rescan** to re-scan any attached hard disks.

6.3.1 Creating a RAID set

To create a RAID set:

1. From the utility main menu, select **Create Volume** and select volume type.
2. Click **Next**.

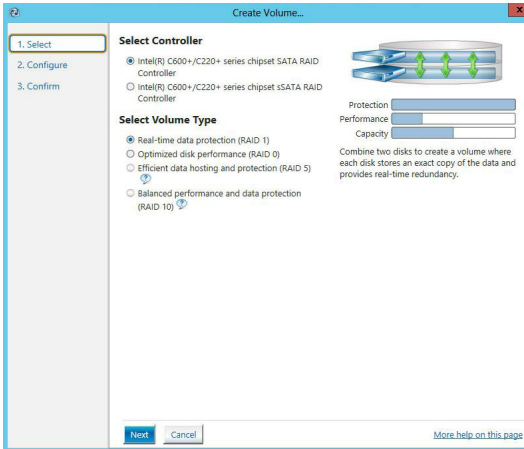

3. Enter a name for the RAID set, then select the array disks.
4. Select **Volume Size** tab, you can drag the bar to decide the volume size.
5. Click **Next**.

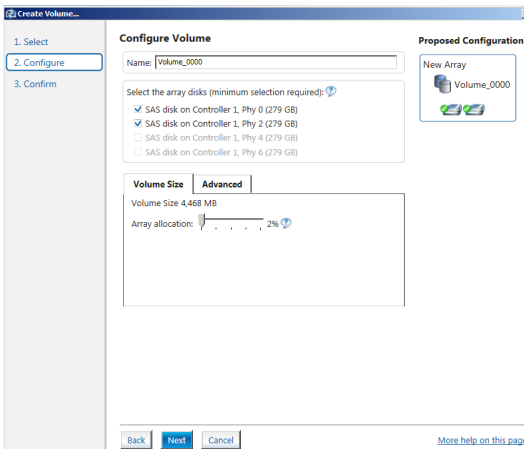

- If you do not want to keep the data on one of the selected disks, select **NO** when prompted.
- If you want to **Enable volume write-back cache** or **Initialize volume**, click **Advanced**.

6. Confirm the volume creation, then click **Create Volume** to continue.



This process could take a while depending on the number and size of the disks. You can continue using other applications during this time.

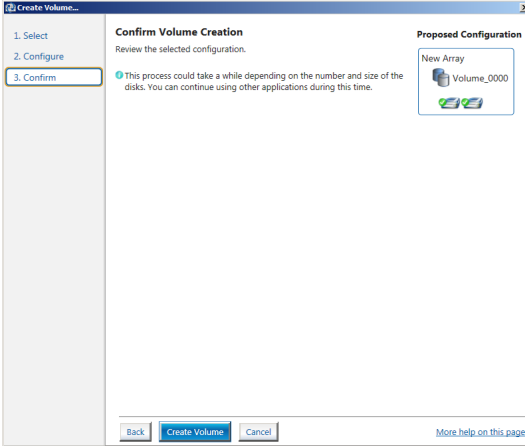

7. Wait until the process is completed, then click **OK** when prompted.

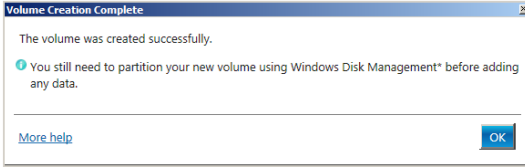

You still need to partition your new volume using Windows Disk Management before adding any data.

The RAID set is displayed in the **Volumes** list and you can change the settings in **Volume Properties**.

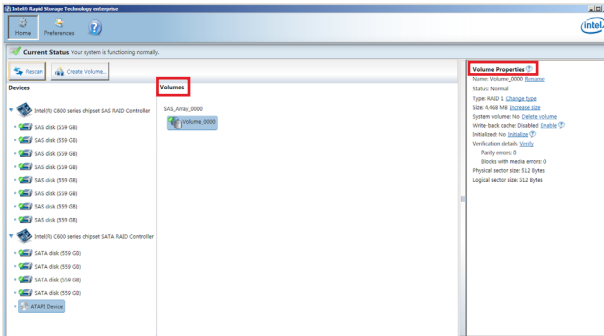

6.3.2 Changing a Volume Type

To change the volume type in **Volume Properties**:

1. Click the SATA array items you want to change in **Volumes** field.
2. From the **Volume Properties** field, select **Type: RAID 1 Change type**.

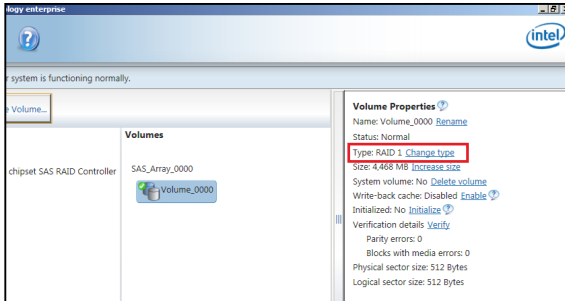

3. You can change the **Name**, **Select the new volume type**, and **Select additional disks to include in the new volume** if needed.
4. Select the **Data stripe size** for the RAID array (for RAID 0, 10 and 5 only), and click **OK**. The available stripe size values range from 4 KB to 128 KB. The following are typical values:
RAID 0: 128KB
RAID 10: 64KB
RAID 5: 64KB

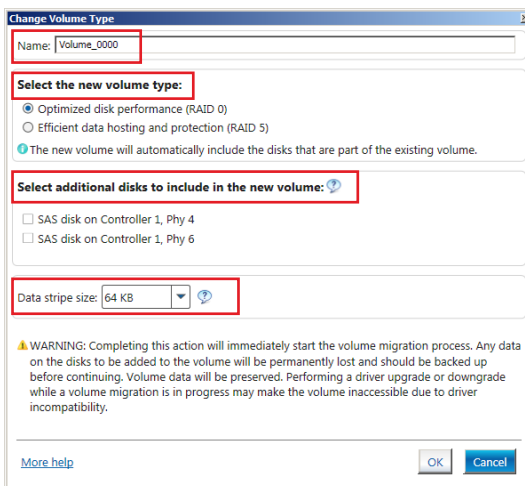

We recommend a lower stripe size for server systems, and a higher stripe size for multimedia computer systems used mainly for audio and video editing.

6.3.3 Deleting a volume



Be cautious when deleting a volume. You will lose all data on the hard disk drives. Before you proceed, ensure that you back up all your important data from your hard drives.

To delete a volume:

1. From the utility main menu, select the volume (ex. Volume_0000) in **Volumes** field you want to delete.

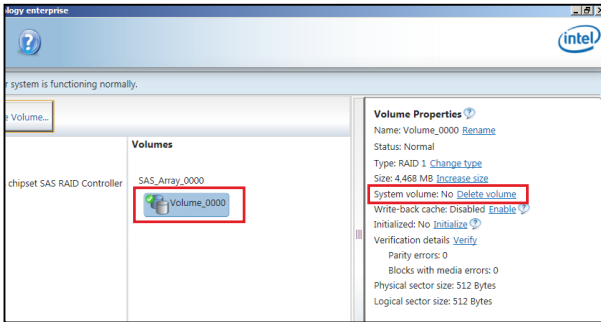

2. Select **Delete volume** in **Volume Properties** field. The following screen appears.

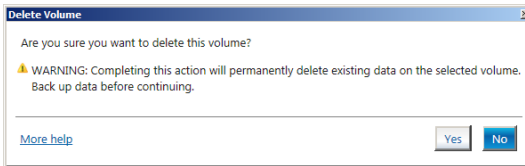

3. Click **Yes** to delete the volume and return to the utility main menu, or click **No** to return to the main menu.

6.3.4 Preferences

System Preferences

Allow you to set to show the notification area icon and show system information, warning, or errors here.

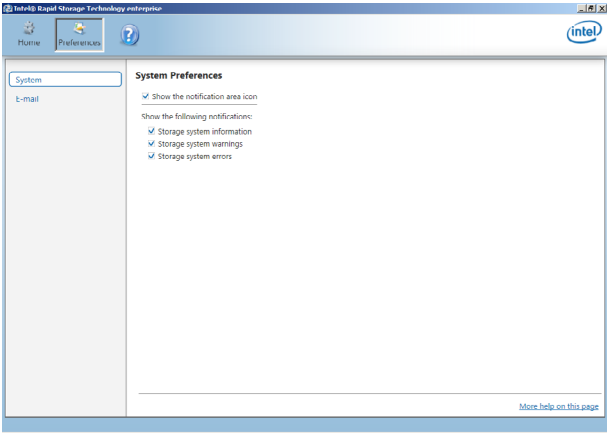

E-Mail Preferences

Allow you to set to sent e-mail of the following events:

- Storage system information
- Storage system warnings
- Storage system errors

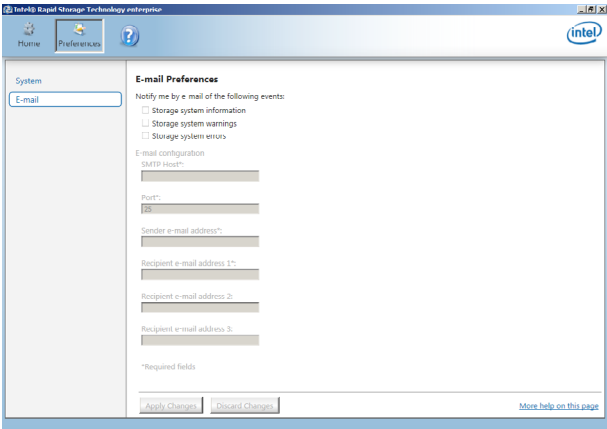

Driver Installation

7

This chapter provides instructions for installing the necessary drivers for different system components.

7.1 RAID driver installation

After creating the RAID sets for your server system, you are now ready to install an operating system to the independent hard disk drive or bootable array. This part provides the instructions on how to install the RAID controller drivers during OS installation.

7.1.1 Creating a USB flash drive with RAID drive

When installing Windows® Server OS, you can load the RAID driver from a USB flash drive. You can create a USB flash drive with RAID driver in Windows by copying the files from the support DVD to the USB flash drive.

To copy the RAID driver to a USB flash drive in Windows environment:

1. Place the motherboard support DVD in the optical drive.
2. Connect a USB flash drive to your system.
3. Click on the optical drive to browse the contents of the support DVD.
4. Click **Drivers > C620 INTEL RAID > Windows > Driver** and then copy the RAID driver folder to the USB flash drive.

7.1.2 Installing the RAID controller driver

During Windows® Server 2012 R2 OS installation

To install the RAID controller driver when installing Windows® Server 2012 R2 OS:

1. Boot the computer using the Windows® Server 2012 R2 OS installation disc. Follow the screen instructions to start installing Windows Server 2012 R2.
2. When prompted to choose a type of installation, click **Custom: Install Windows only (advanced)**.

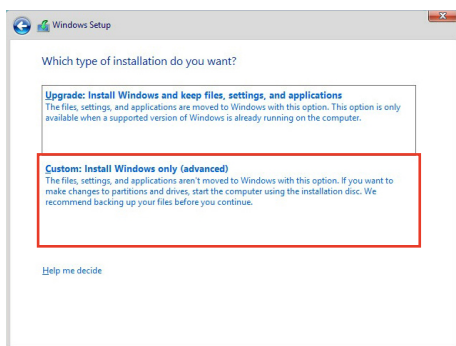

3. Click **Load Driver**.

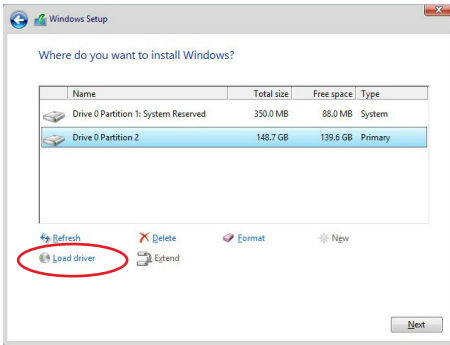

4. A message appears reminding you to insert the installation media containing the driver of the RAID controller driver (the installation media can be a CD, DVD, or USB flash drive).
- If you have only one optical drive installed in your system, eject the Windows OS installation disc and replace with the motherboard Support DVD into the optical drive.
 - Or you may connect a USB flash drive containing the RAID controller driver.

Click **Browse** to continue.

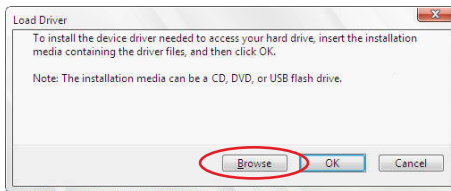

5. Locate the driver in the corresponding folder of the Support DVD or USB flash drive and then click **OK** to continue.
6. Select the RAID controller driver you need from the list and click **Next**.

7. When the system finishes loading the RAID driver,
 - Replace the motherboard Support DVD with the Windows Server installation disc.
 - Remove the USB flash drive.

Select the drive to install Windows and click **Next**.

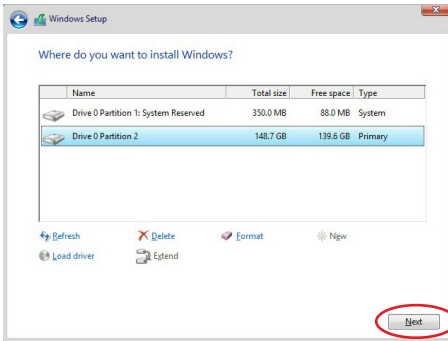

8. Setup then proceeds with the OS installation. Follow screen instructions to continue.

7.2 Management applications and utilities installation

The support DVD that is bundled with your motherboard contains drivers, management applications, and utilities that you can install to maximize the features of your motherboard.



1. The contents of the support DVD are subject to change at any time without notice. Visit the ASUS website (www.asus.com) for the latest updates on software and utilities.
2. The support DVD is supported on Windows® Server 2012 R2 and Windows® Server 2016.

7.3 Running the Support DVD

When you place the support DVD into the optical drive, the DVD automatically displays the main screen if Autorun is enabled in your computer. By default, the Drivers tab is displayed.



If Autorun is NOT enabled in your computer, browse the contents of the support DVD to locate the file **ASSETUP.EXE** from the **BIN** folder. Double-click the **ASSETUP.EXE** to run the support DVD.

The main screen of the Support DVD contains the following tabs:

1. Drivers
2. Utilities
3. Manual
4. Contact



The main screen of the Support DVD looks exactly the same on the Windows® Server 2012 R2 and on the Windows® Server 2016 Operating System (OS).

7.3.1 Drivers menu tab

The Drivers Menu shows the available device drivers if the system detects installed devices. Install the necessary drivers to activate the devices.

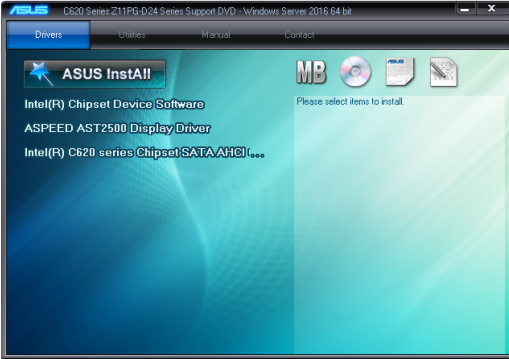

7.3.2 Utilities menu tab

The Utilities menu displays the software applications and utilities that the motherboard supports.



7.3.3 Manual menu

The Manual menu provides a list of supplementary user guides.



You need an internet browser installed in your OS to view the User Guide.



7.3.4 Contact information menu

The Contact menu displays the ASUS contact information, e-mail addresses, and useful links if you need more information or technical support for your motherboard.

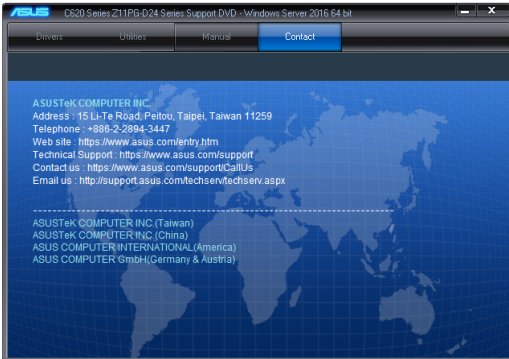

7.4 Intel® chipset device software installation

This section provides the instructions on how to install the Intel® chipset device software on the system.

You need to manually install the Intel® chipset device software on a Windows operating system.

To install the Intel® chipset device software:

1. Restart the computer, and then log on with **Administrator** privileges.
2. Insert the motherboard/system support DVD into the optical drive. The support DVD automatically displays the **Drivers** menu if Autorun is enabled in your computer.



If Autorun is NOT enabled in your computer, browse the contents of the support DVD to locate the file **ASSETUP.EXE** from the **BIN** folder. Double-click the **ASSETUP.EXE** to run the support DVD.

3. Click the item **Intel® Chipset Device Software** from the menu.

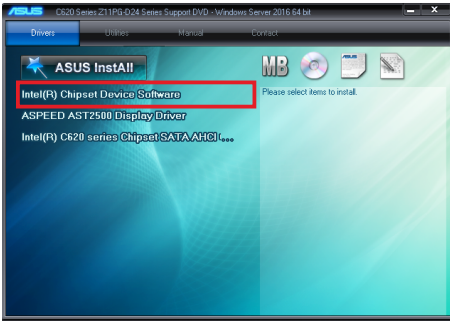

4. The **Intel® Chipset Device Software** window appears. Click **Next** to start the installation.

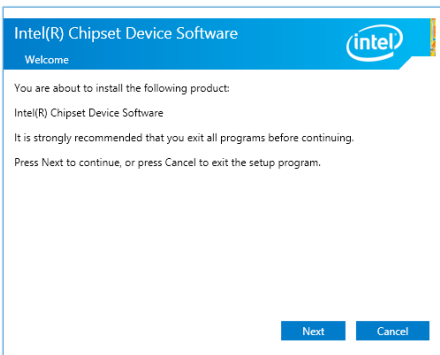

5. Read the **License Agreement** and click **Accept** to continue the process.

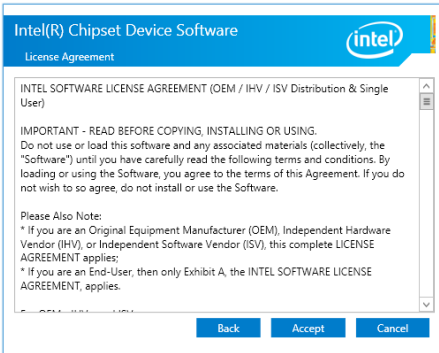

6. Read the **Readme File Information** and click **Install** to start the installation process.

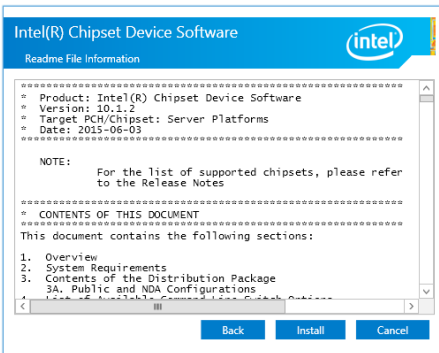

7. Click **Restart Now** to complete the setup process.

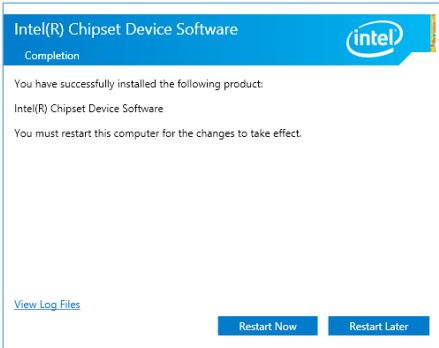

7.5 VGA driver installation

This section provides the instructions on how to install the ASPEED Video Graphics Adapter (VGA) driver.

You need to manually install the ASPEED VGA driver on a Windows® operating system.

To install the ASPEED VGA driver:

1. Restart the computer, and then log on with **Administrator** privileges.
2. Insert the motherboard/system support DVD into the optical drive. The support DVD automatically displays the **Drivers** menu if Autorun is enabled in your computer.



If Autorun is NOT enabled in your computer, browse the contents of the support DVD to locate the file **ASSETUP.EXE** from the **BIN** folder. Double-click the **ASSETUP.EXE** to run the support DVD.

3. Click the **ASPEED AST2500 Display Driver** to begin installation.

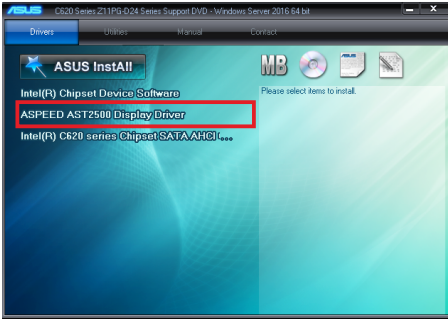

4. From the installation window, click **Next** to start the installation.



5. Click **Install** to start the installation process.

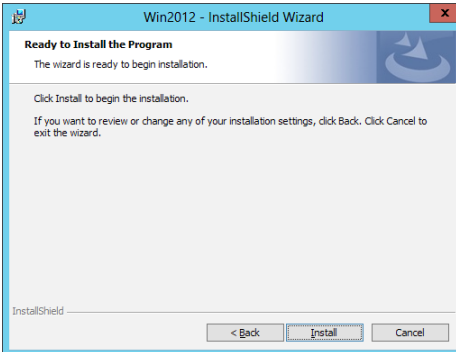

6. Click **Finish** to complete the installation.

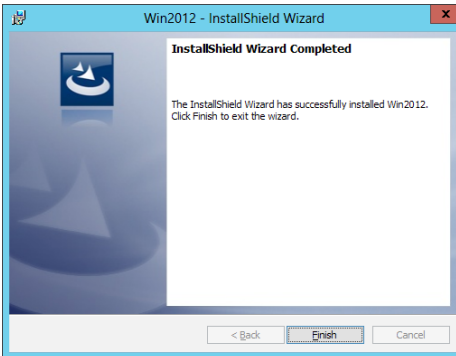

7.6 Intel® Rapid Storage Technology enterprise installation

This section provides the instructions on how to install the Intel® Rapid Storage Technology enterprise 5.0 on the system.

You need to manually install the Intel® Rapid Storage Technology enterprise 5.0 utility on a Windows® operating system.

To install the Intel® Rapid Storage Technology enterprise 5.0 utility:

1. Restart the computer, and then log on with **Administrator** privileges.
2. Insert the motherboard/system support DVD into the optical drive, and navigate to the **Utilities** menu.
3. Click the **Intel® Rapid Storage Technology enterprise** to begin installation.



4. The **Intel® Rapid Storage Technology enterprise** window appears. Click **Next** to start the installation.

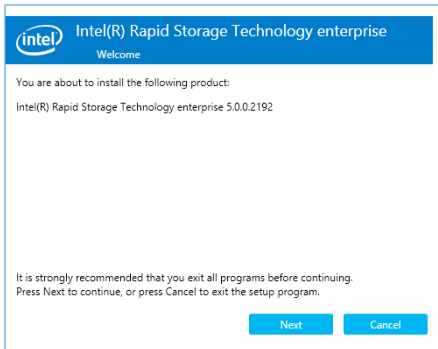

5. Read the **Warning** message and click **Next** to continue.

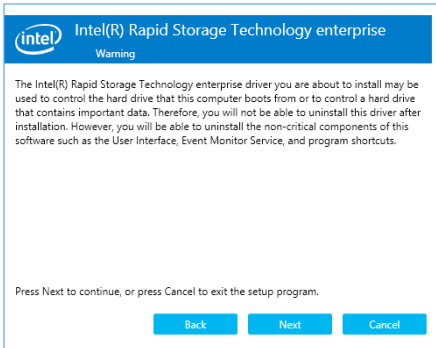

6. Read the **License Agreement** and click **Accept** to continue the process.

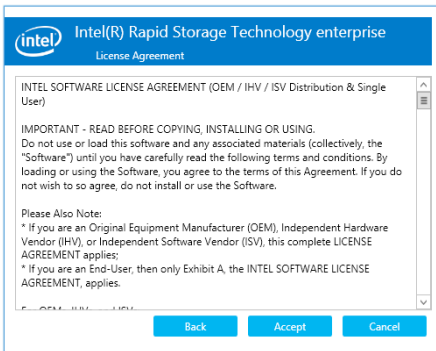

7. Select the destination folder and click **Next** to continue.

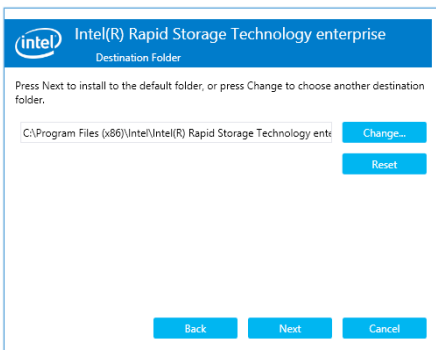

8. Tick the features that you would like to install and click **Next** to continue.

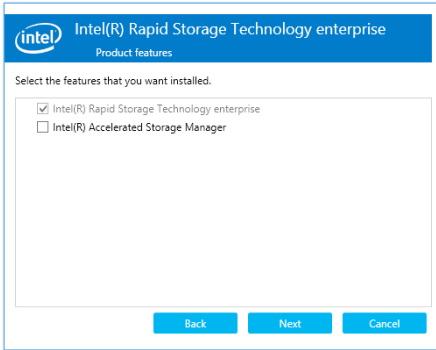

9. Click **Install** to start the installation process.

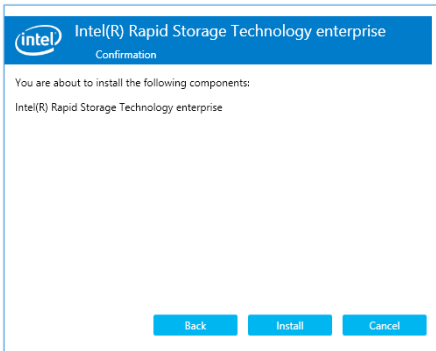

10. Click **Restart Now** to complete the setup process.

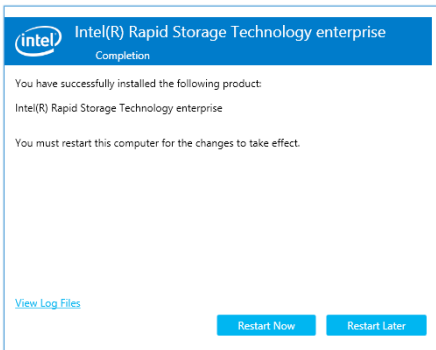

Appendix

This appendix includes additional information that you may refer to when configuring the motherboard.

ESC8000 G4 block diagram (Single Root)

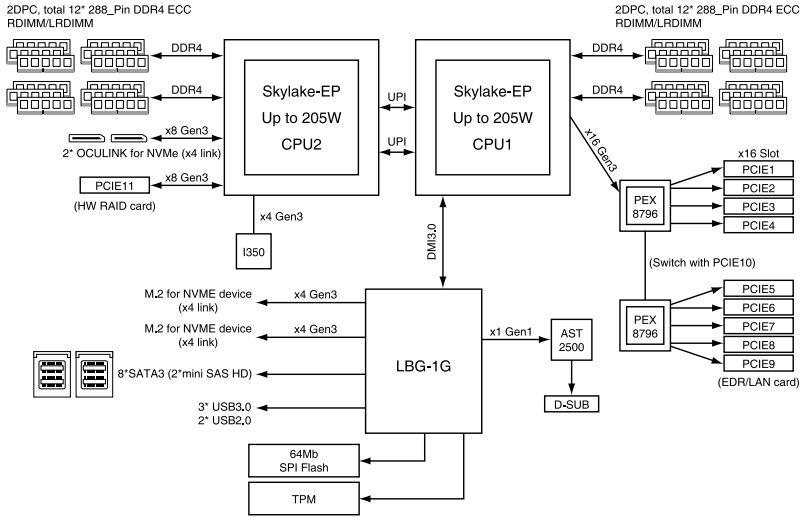

ESC8000 G4 block diagram (Dual Root)

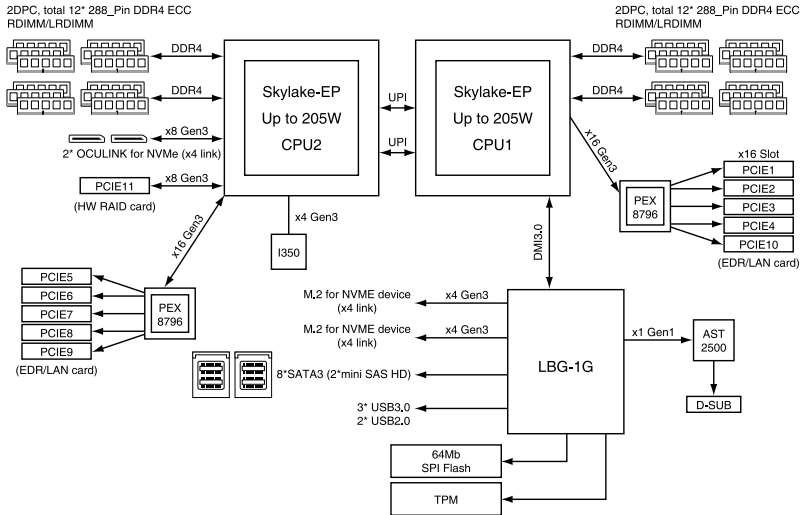

ESC8000 G4/10G block diagram (Single Root)

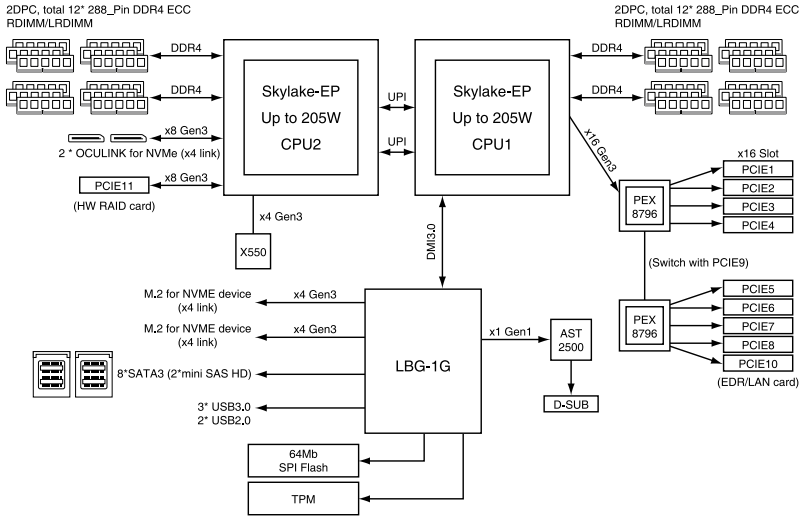

ESC8000 G4/10G block diagram (Dual Root)

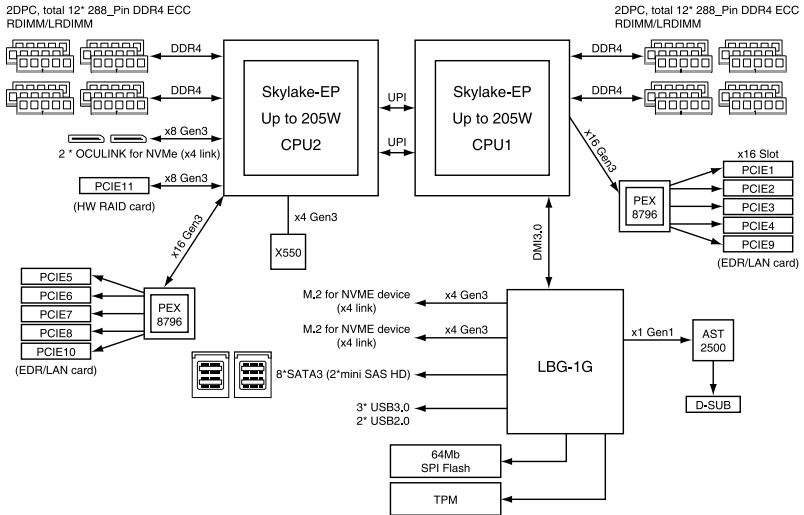

Changing System PCI-E Topology

Changing the system PCI-E topology through the BIOS setup program:

1. Launch the BIOS setup program.



Refer to section 5.2 BIOS setup program for the steps on launching the BIOS setup program.

2. Navigate to the **Advanced** menu.
3. Select **System Topology** and press [Enter], then select [**Single Root**] or [**Dual Root**] to change your System PCI-E Topology.

Changing the system PCI-E topology through the ASMB9-iKVM Web-based user interface:

1. Log in to the ASMB9-iKVM utility.



Refer to the user manual that came with your ASMB9 management card for the steps on setting up and launching the ASMB9-iKVM Web-based user interface.

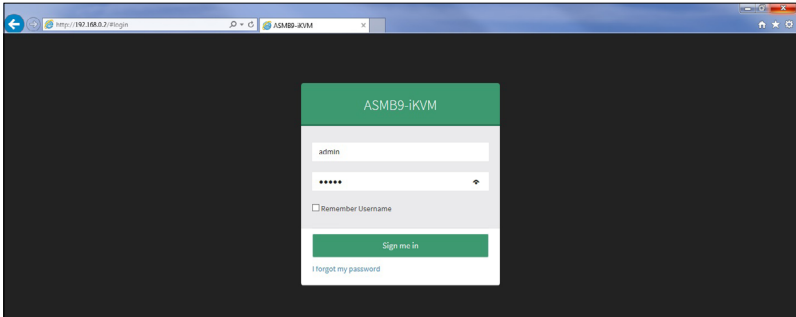

2. Navigate to the **Settings** function, then select **System Topology**.

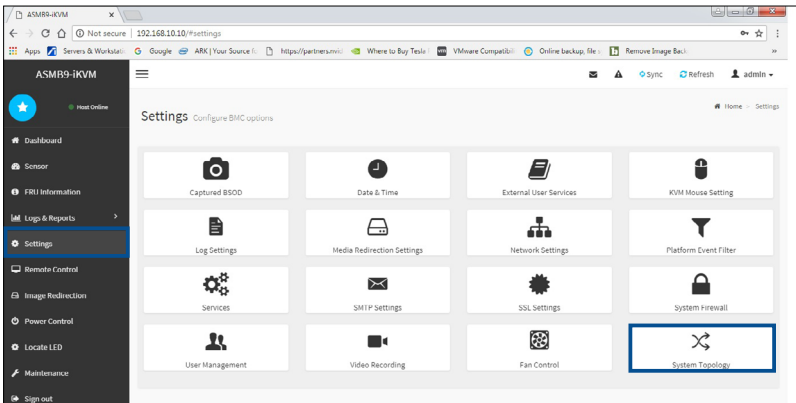

3. Select **Single Root** or **Dual Root** to change your System PCI-E Topology, then click **Save**.

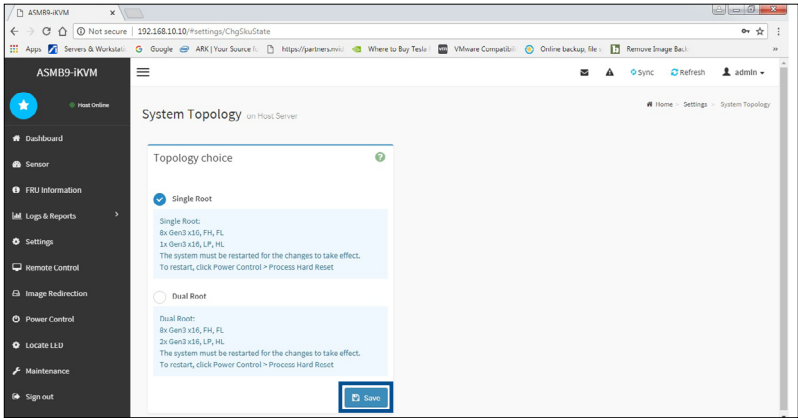

4. Navigate to the **Power Control** function, select **Hard Reset**, then click **Perform Action** to complete.

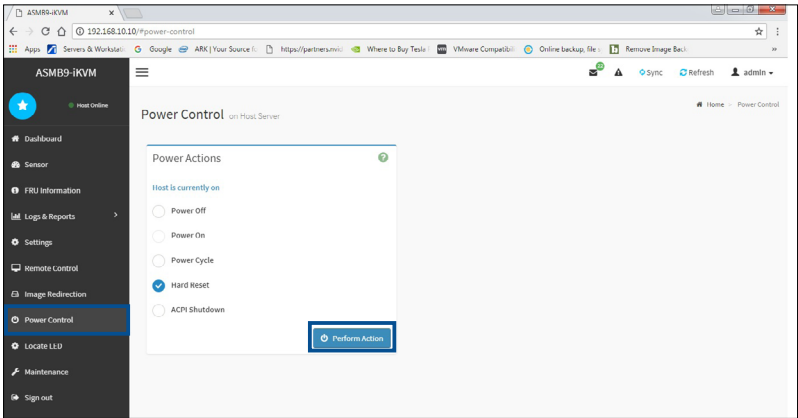

Q-Code table

Code	Description
00	Not used
02	microcode
03	CACHE_ENABLED
04	PCH initialization
06	CPU_EARLY_INIT
10	PEI Core is started
11 – 14	Pre-memory CPU initialization is started
15 – 18	Pre-memory System Agent initialization is started
19 – 1C	Pre-memory PCH initialization is started
2B – 2F	Memory initialization
30	Reserved for ASL (see ASL Status Codes section below)
31	Memory Installed
32 – 36	CPU post-memory initialization
37 – 3A	Post-Memory System Agent initialization is started
3B – 3E	Post-Memory PCH initialization is started
4F	DXE IPL is started
50 – 53	Memory initialization error. Invalid memory type or incompatible memory speed
4F	DXE IPL is started
54	Unspecified memory initialization error
55	Memory not installed
56	Invalid CPU type or Speed
57	CPU mismatch
58	CPU self test failed or possible CPU cache error
59	CPU micro-code is not found or micro-code update is failed
5A	Internal CPU error
5B	Reset PPI is not available
5C – 5F	Reserved for future AML error codes
E0	S3 Resume is started (S3 Resume PPI is called by the DXE IPL)
E1	S3 Boot Script execution
E2	Video repost
E3	OS S3 wake vector call
E4 – E7	Reserved for future AML progress codes
E8	S3 Resume Failed
E9	S3 Resume PPI not Found
EA	S3 Resume Boot Script Error
EB	S3 OS Wake Error
EC – EF	Reserved for future AML error codes
F0	Recovery condition triggered by firmware (Auto recovery)
F1	Recovery condition triggered by user (Forced recovery)
F2	Recovery process started
F3	Recovery firmware image is found
F4	Recovery firmware image is loaded
F5 – F7	Reserved for future AML progress codes
F8	Recovery PPI is not available
F9	Recovery capsule is not found

(continued on the next page)

Code	Description
FA	Invalid recovery capsule
FB – FF	Reserved for future AMI error codes
60	DXE Core is started
61	NVRAM initialization
62	Installation of the PCH Runtime Services
63 – 67	CPU DXE initialization is started
68	PCI host bridge initialization
69	System Agent DXE initialization is started
6A	System Agent DXE SMM initialization is started
6B – 6F	System Agent DXE initialization (System Agent module specific)
70	PCH DXE initialization is started
71	PCH DXE SMM initialization is started
72	PCH devices initialization
73 – 77	PCH DXE Initialization (PCH module specific)
78	ACPI module initialization
79	CSM initialization
7A – 7F	Reserved for future AMI DXE codes
90	Boot Device Selection (BDS) phase is started
91	Driver connecting is started
92	PCI Bus initialization is started
93	PCI Bus Hot Plug Controller Initialization
94	PCI Bus Enumeration
95	PCI Bus Request Resources
96	PCI Bus Assign Resources
97	Console Output devices connect
98	Console input devices connect
99	Super IO Initialization
9A	USB initialization is started
9B	USB Reset
9C	USB Detect
9D	USB Enable
9E – 9F	Reserved for future AMI codes
A0	IDE initialization is started
A1	IDE Reset
A2	IDE Detect
A3	IDE Enable
A4	SCSI initialization is started
A5	SCSI Reset
A6	SCSI Detect
A7	SCSI Enable
A8	Setup Verifying Password
A9	Start of Setup
AA	Reserved for ASL (see ASL Status Codes section below)
AB	Setup Input Wait

(continued on the next page)

Code	Description
AC	Reserved for ASL (see ASL Status Codes section below)
AD	Ready To Boot event
AE	Legacy Boot event
AF	Exit Boot Services event
B0	Runtime Set Virtual Address MAP Begin
B1	Runtime Set Virtual Address MAP End
B2	Legacy Option ROM Initialization
B3	System Reset
B4	USB hot plug
B5	PCI bus hot plug
B6	Clean-up of NVRAM
B7	Configuration Reset (reset of NVRAM settings)
B8– BF	Reserved for future AMI codes
D0	CPU initialization error
D1	System Agent initialization error
D2	PCH initialization error
D3	Some of the Architectural Protocols are not available
D4	PCI resource allocation error. Out of Resources
D5	No Space for Legacy Option ROM
D6	No Console Output Devices are found
D7	No Console Input Devices are found
D8	Invalid password
D9	Error loading Boot Option (LoadImage returned error)
DA	Boot Option is failed (StartImage returned error)
DB	Flash update is failed
DC	Reset protocol is not available

ACPI/ASL Checkpoints (under OS)

Code	Description
03	System is entering S3 sleep state
04	System is entering S4 sleep state
05	System is entering S5 sleep state
30	System is waking up from the S3 sleep state
40	System is waking up from the S4 sleep state
AC	System has transitioned into ACPI mode. Interrupt controller is in PIC mode.
AA	System has transitioned into ACPI mode. Interrupt controller is in APIC mode.

Notices

Federal Communications Commission Statement

This device complies with Part 15 of the FCC Rules. Operation is subject to the following two conditions:

- This device may not cause harmful interference, and
- This device must accept any interference received including interference that may cause undesired operation.

This equipment has been tested and found to comply with the limits for a Class A digital device, pursuant to part 15 of the FCC Rules. These limits are designed to provide reasonable protection against harmful interference when the equipment is operated in a commercial environment. This equipment generates, uses, and can radiate radio frequency energy and, if not installed and used in accordance with the instruction manual, may cause harmful interference to radio communications. Operation of this equipment in a residential area is likely to cause harmful interference in which case the user will be required to correct the interference at his own expense.



The use of shielded cables for connection of the monitor to the graphics card is required to assure compliance with FCC regulations. Changes or modifications to this unit not expressly approved by the party responsible for compliance could void the user's authority to operate this equipment.

Compliance Statement of Innovation, Science and Economic Development Canada (ISED)

This device complies with Innovation, Science and Economic Development Canada licence exempt RSS standard(s). Operation is subject to the following two conditions: (1) this device may not cause interference, and (2) this device must accept any interference, including interference that may cause undesired operation of the device.

CAN ICES-3(A)/NMB-3(A)

Déclaration de conformité de Innovation, Sciences et Développement économique Canada (ISED)

Le présent appareil est conforme aux CNR d'Innovation, Sciences et Développement économique Canada applicables aux appareils radio exempts de licence. L'exploitation est autorisée aux deux conditions suivantes : (1) l'appareil ne doit pas produire de brouillage, et (2) l'utilisateur de l'appareil doit accepter tout brouillage radioélectrique subi, même si le brouillage est susceptible d'en compromettre le fonctionnement.

CAN ICES-3(A)/NMB-3(A)

REACH

Complying with the REACH (Registration, Evaluation, Authorization, and Restriction of Chemicals) regulatory framework, we published the chemical substances in our products at ASUS website at <http://csr.asus.com/english/REACH.htm>.

ASUS Recycling/Takeback Services

ASUS recycling and takeback programs come from our commitment to the highest standards for protecting our environment. We believe in providing solutions for you to be able to responsibly recycle our products, batteries, other components as well as the packaging materials. Please go to <http://csr.asus.com/english/Takeback.htm> for detailed recycling information in different regions.



DO NOT throw the motherboard in municipal waste. This product has been designed to enable proper reuse of parts and recycling. This symbol of the crossed out wheeled bin indicates that the product (electrical and electronic equipment) should not be placed in municipal waste. Check local regulations for disposal of electronic products.



DO NOT throw the mercury-containing button cell battery in municipal waste. This symbol of the crossed out wheeled bin indicates that the battery should not be placed in municipal waste.

Australia statement notice

From 1 January 2012 updated warranties apply to all ASUS products, consistent with the Australian Consumer Law. For the latest product warranty details please visit <https://www.asus.com/support/>. Our goods come with guarantees that cannot be excluded under the Australian Consumer Law. You are entitled to a replacement or refund for a major failure and compensation for any other reasonably foreseeable loss or damage. You are also entitled to have the goods repaired or replaced if the goods fail to be of acceptable quality and the failure does not amount to a major failure.

If you require assistance please call ASUS Customer Service 1300 2787 88 or visit us at <https://www.asus.com/support/>.

ASUS contact information

ASUSTeK COMPUTER INC.

Address 4F, No. 150, Li-Te Rd., Peitou, Taipei 112, Taiwan
Telephone +886-2-2894-3447
Fax +886-2-2890-7798
Web site <https://www.asus.com>

Technical Support

Telephone +86-21-38429911
Fax +86-21-58668722 ext: 9101
Online Support <https://www.asus.com/support/Product/ContactUs/Services/questionform/?lang=en>

ASUSTeK COMPUTER INC. (Taiwan)

Address 4F, No. 150, Li-Te Rd., Peitou, Taipei 112, Taiwan
Telephone +886-2-2894-3447
Fax +886-2-2890-7798
Web site <https://www.asus.com/tw/>

Technical Support

Telephone +886-2-2894-3447 (0800-093-456)
Online Support <https://www.asus.com/support/Product/ContactUs/Services/questionform/?lang=zh-tw>

ASUSTeK COMPUTER INC. (China)

Address No. 5077, Jindu Road, Minhang District, Shanghai, China
Telephone +86-21-5442-1616
Fax +86-21-5442-0099
Web site <https://www.asus.com.cn>

Technical Support

Telephone +86-20-2804-7506 (400-620-6655)
Online Support <https://www.asus.com/support/Product/ContactUs/Services/questionform/?lang=zh-cn>

ASUS contact information

ASUS COMPUTER INTERNATIONAL (America)

Address 48720 Kato Rd., Fremont, CA 94538, USA
Fax +1-510-608-4555
Web site <https://www.asus.com/us/>

Technical Support

Support fax +1-812-284-0883
General support +1-812-282-2787
Online support <https://www.asus.com/support/Product/ContactUs/Services/questionform/?lang=en-us>

ASUS COMPUTER GmbH (Germany and Austria)

Address Harkort Str. 21-23, 40880 Ratingen, Germany
Fax +49-2102-959911
Web site <https://www.asus.com/de/>

Technical Support

Telephone +49-1805-010923
Support Fax +49-2102-959911
Online support <https://www.asus.com/support/Product/ContactUs/Services/questionform/?lang=de-de>

ASUS Czech Service s.r.o. (Europe)

Address Na Rovince 887, 720 00 Ostrava – Hrabová,
Czech Republic
Telephone +420-596766888
Web site <https://www.asus.com/cz/>

Technical Support

Telephone +420-596-766-891
Fax +420-596-766-329
E-mail advance.rma.eu@asus.com
Online Support <https://www.asus.com/support/Product/ContactUs/Services/questionform/?lang=cs-cz>

ASUS contact information

ASUS Holland BV (The Netherlands)

Address Marconistraat 2, 7825GD EMMEN, The Netherlands
Web site <https://www.asus.com/nl/>

Technical Support

Telephone +31-(0)591-5-70292
Fax +31-(0)591-666853
E-mail advance.rma.eu@asus.com
Online Support <https://www.asus.com/support/Product/ContactUs/Services/questionform/?lang=nl-nl>

ASUS Polska Sp. z o.o. (Poland)

Address Ul. Postępu 6, 02-676 Warszawa, Poland
Web site <https://www.asus.com/pl/>

Technical Support

Telephone +48-225718033
Online Support <https://www.asus.com/support/Product/ContactUs/Services/questionform/?lang=pl-pl>

ASK-Service (Russia and CIS)

Address г.Москва, ул. Орджоникидзе, д.10, Россия
Telephone (495) 640-32-75
Web site <https://www.asus.com/ru/>

Technical Support

Telephone 008-800-100-ASUS (008-800-100-2787)
Online Support <https://www.asus.com/support/Product/ContactUs/Services/questionform/?lang=ru-ru>

