



RAZER ORNATA V3 X

MASTER GUIDE

Take the first step towards next-level performance with the **Razer Ornata V3 X**—a low-profile ergonomic gaming keyboard designed to elevate your work and play. Featuring a new ultra-slim form factor, more durable keycaps, and Razer Chroma™ RGB, it is the perfect introduction to our unfair advantage.

CONTENTS

1. WHAT'S INSIDE	3
2. WHAT'S NEEDED	5
3. LET'S GET YOU COVERED	5
4. TECHNICAL SPECIFICATIONS.....	6
5. SETTING UP YOUR KEYBOARD	7
6. USING YOUR RAZER ORNATA V3 X.....	8
7. CONFIGURING YOUR RAZER ORNATA V3 X.....	10
8. SAFETY AND MAINTENANCE	21
9. LEGALESE	23

1. WHAT'S INSIDE

- Razer Ornata V3 X

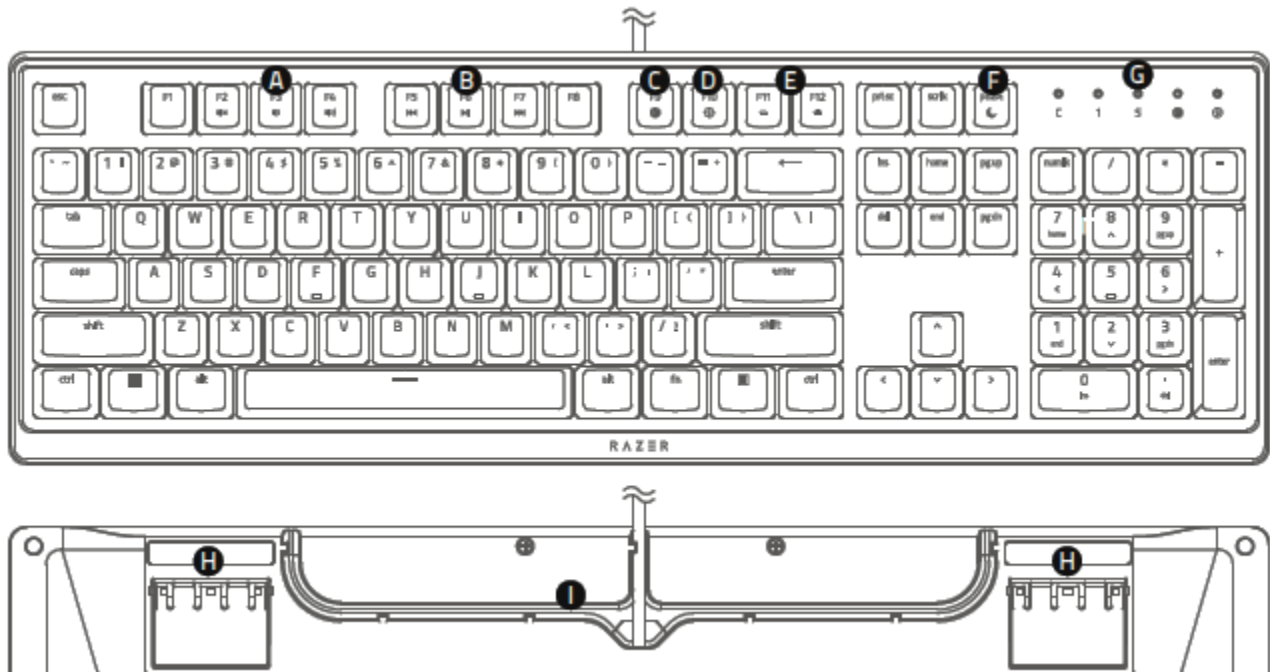

- A. Volume control keys
- B. Media keys
- C. On-The-Fly macro record key
- D. Gaming mode key
- E. Backlight control keys
- F. Sleep mode key
- G. LED indicators
- H. Kickstand
- I. Cable routing options

- Ergonomic wrist rest



- Important Product Information Guide

2. WHAT'S NEEDED

PRODUCT REQUIREMENTS

- PC with a free USB Type A port

RAZER SYNAPSE REQUIREMENTS

- Windows® 10 64-bit (or higher)
- Internet connection for software installation

3. LET'S GET YOU COVERED

You've got a great device in your hands, complete with a 2-year limited warranty coverage. Now maximize its potential and score exclusive Razer benefits by registering at razerid.razer.com

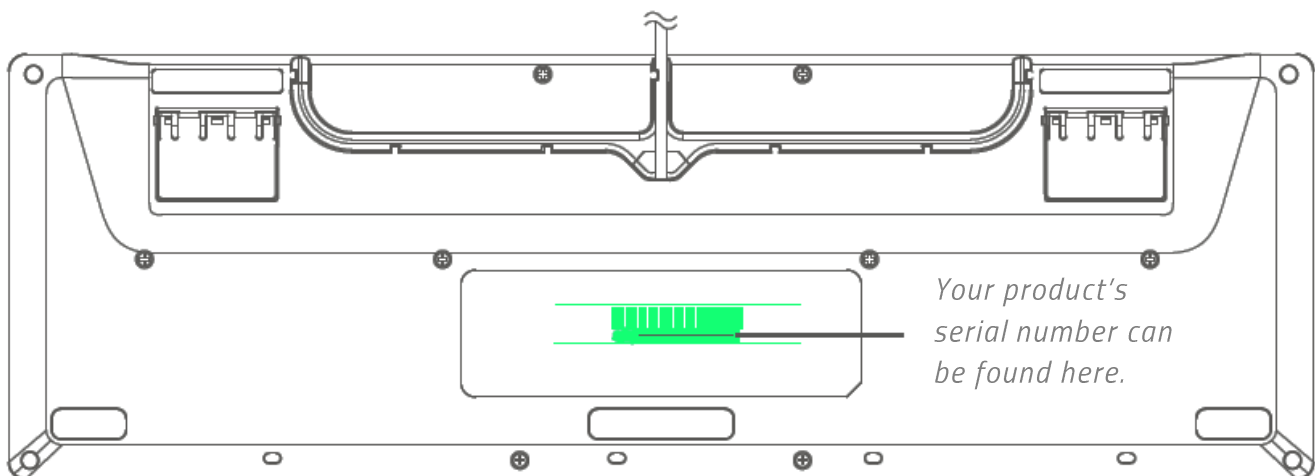

Got a question? Ask the Razer Support Team at support.razer.com

4. TECHNICAL SPECIFICATIONS

FEATURES

- Soft cushioned gaming-grade keys
- UV-coated Textured ABS Keycaps
- Single Zone Razer Chroma™ RGB Lighting
- Durable spill-resistant design
- Wrist Rest Included
- Cable routing options
- Razer Synapse enabled
- Fully programmable keys with on-the-fly macro recording
- 6-key roll over
- Gaming mode option
- Braided fiber cable
- 1000 Hz Ultrapolling

APPROXIMATE SIZE & WEIGHT

- Length: 443.1 mm / 17.4 in
- Width: 229.4 mm / 9.0 in
- Height: 31.4 mm / 1.2 in
- Weight: 916.8 g / 2.0 lbs

5. SETTING UP YOUR KEYBOARD

1. Connect your Razer device to the USB port of your computer.

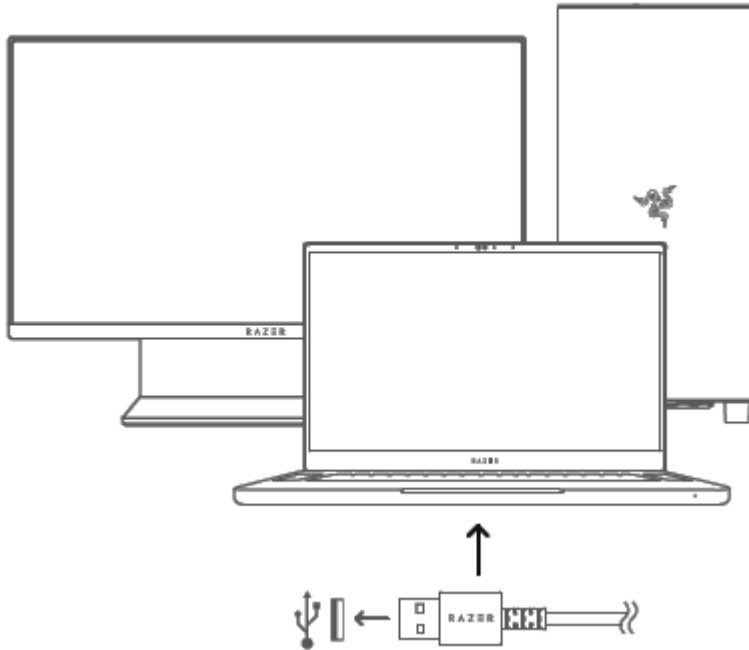

2. Position the wrist rest below your keyboard then slide it in.

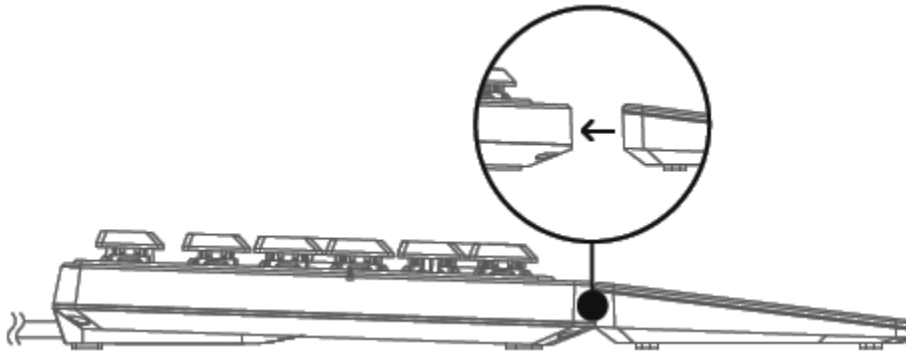













3. Use the Razer Synapse app to customize your keyboard's lighting and even create various profiles suited for different playstyles.

i Install Razer Synapse when prompted or download the installer from razer.com/synapse.

6. USING YOUR RAZER ORNATA V3 X

No need to press and hold the Function (FN) key, now all media keys are at the forefront of your keyboard.

Primary keys	Description
	The Audio Volume Control keys allow you to mute (), decrease () and increase () the audio output.
	The Media keys allow you to play/pause () a track or skip tracks backward () and forward ().
	The Backlight Control keys allow you to decrease () or increase () the brightness of your keyboard's LEDs.
	The Sleep key allows you to suspend all operating system activities. This function allows you to save electricity while the computer is idle.

ON-THE-FLY MACRO RECORDING



Follow these steps to create an OTF Macro Recording:

i *Razer Synapse must be installed and running when recording macros.*

1. Press the key combination to start recording. The On-The-Fly macro record key will light up to show that the device is ready to record.
2. Type in the keys you want to record.
3. Press the key combination to stop the recording or the ESC key to cancel recording. The On-The-Fly macro record key will start blinking to show that the device has stopped recording and is ready to save the macro.
4. Press the desired key where you want to save your macro.

GAMING MODE



Gaming Mode disables the Windows Key, Menu/Apps Key, Alt + Tab, and Alt + F4 functions to avoid accidental usage. You can choose to enable the Alt + Tab and Alt + F4 functions by changing the Gaming Mode settings on Razer Synapse. The Gaming mode key will light up when it is active.

7. CONFIGURING YOUR RAZER ORNATA V3 X

- i** *Internet connection is required for installation, updates and cloud-based features. Registering for a Razer ID account is recommended, but optional. All listed features are subject to change based on the current software version, connected device(s), and supported apps and software.*

SYNAPSE TAB

The Synapse tab is your default tab when you first launch Razer Synapse.

Dashboard

The Dashboard subtab is an overview of your Razer Synapse where you can access all your Razer devices, modules, and online services.

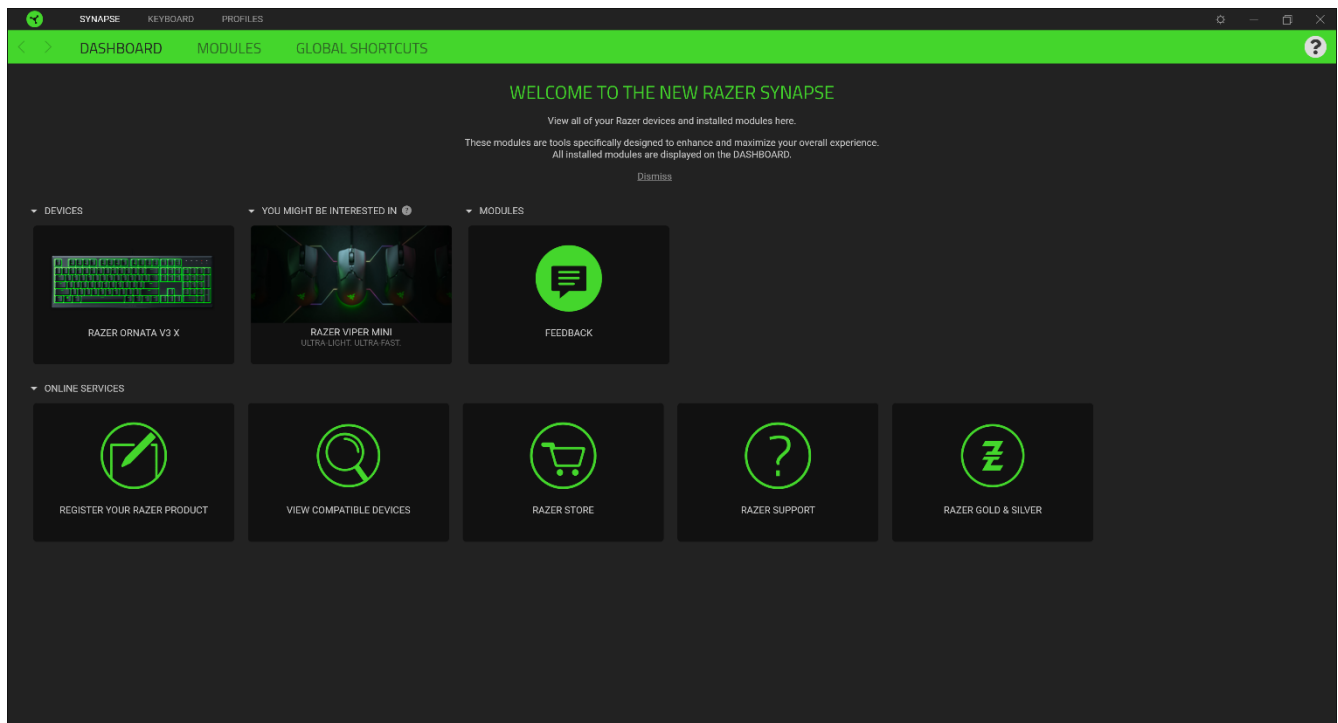

Modules

The Modules subtab displays all installed and available modules for installation.

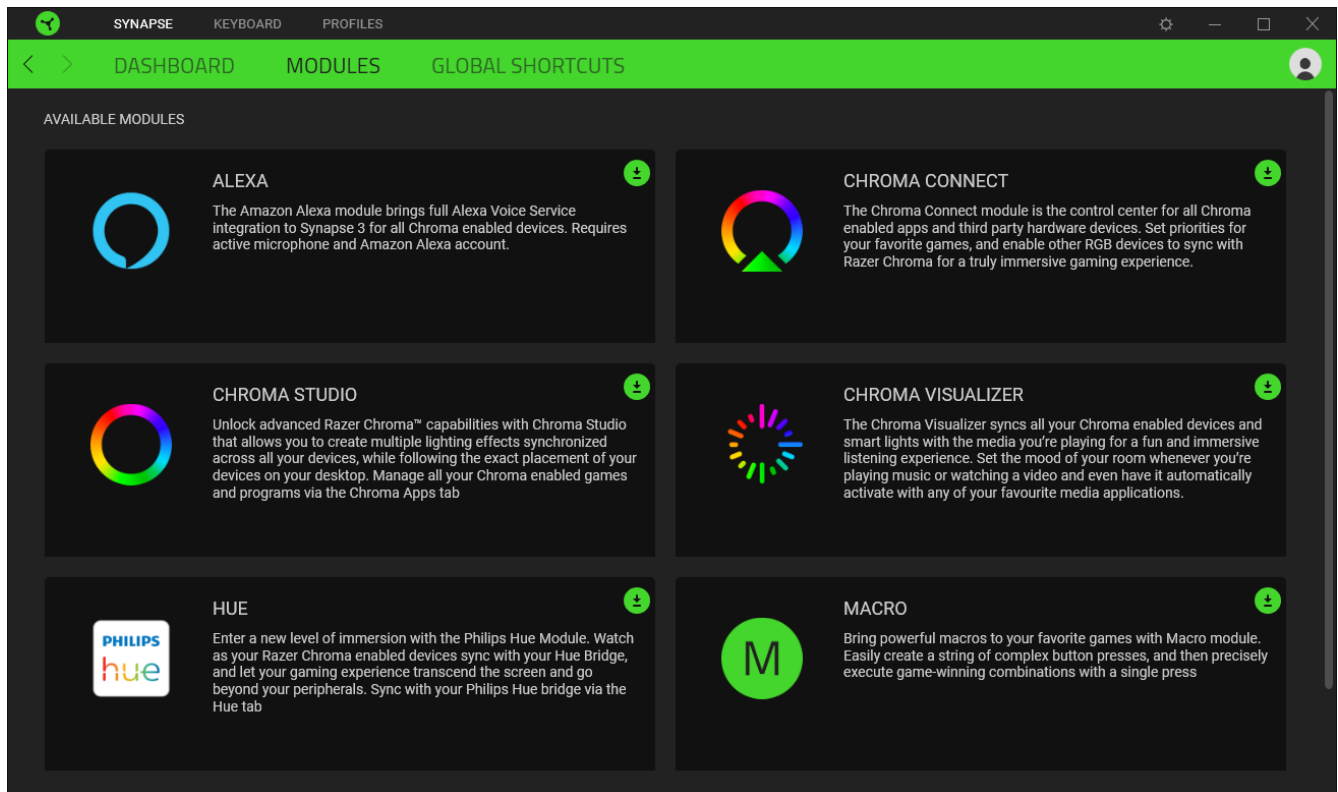

Global Shortcuts

Bind operations or Razer Synapse functions to custom key-combinations from any Razer Synapse-enabled device inputs which apply across all device profiles. [Learn more about Profiles](#)

i Only Razer Synapse-enabled device inputs will be recognized.

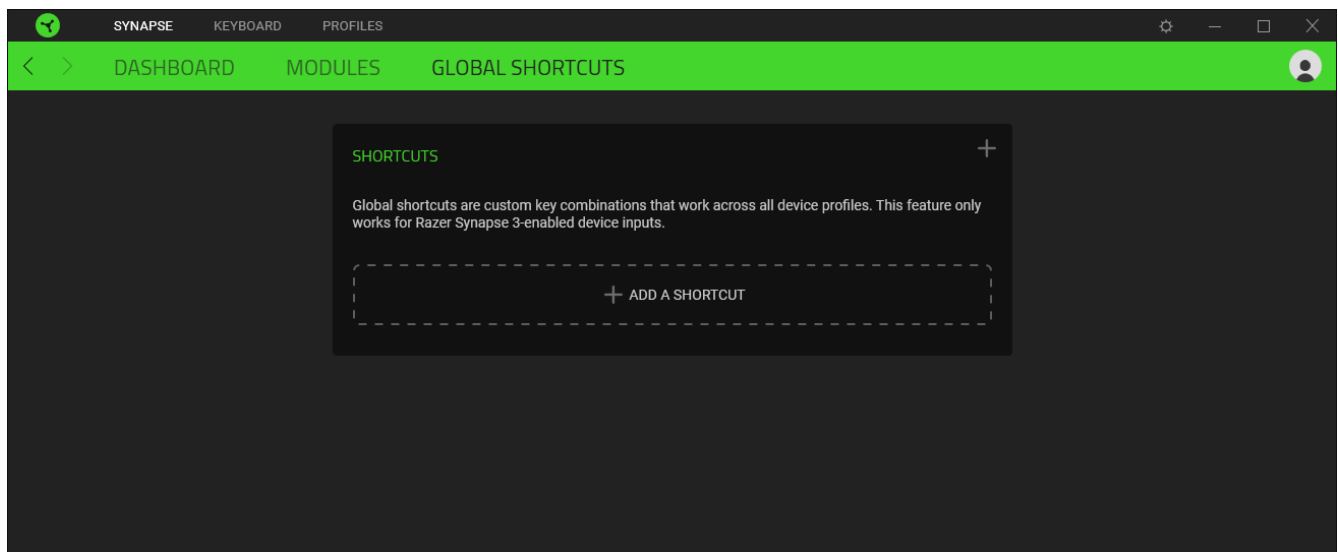

KEYBOARD

The Keyboard tab is the main tab for your Razer Ornata V3 X. From here, you can change your device settings such as key assignments and your device's lighting. Changes made under this tab are automatically saved to your system and cloud storage.

Customize

The Customize subtab is for modifying your keyboard's key assignments.

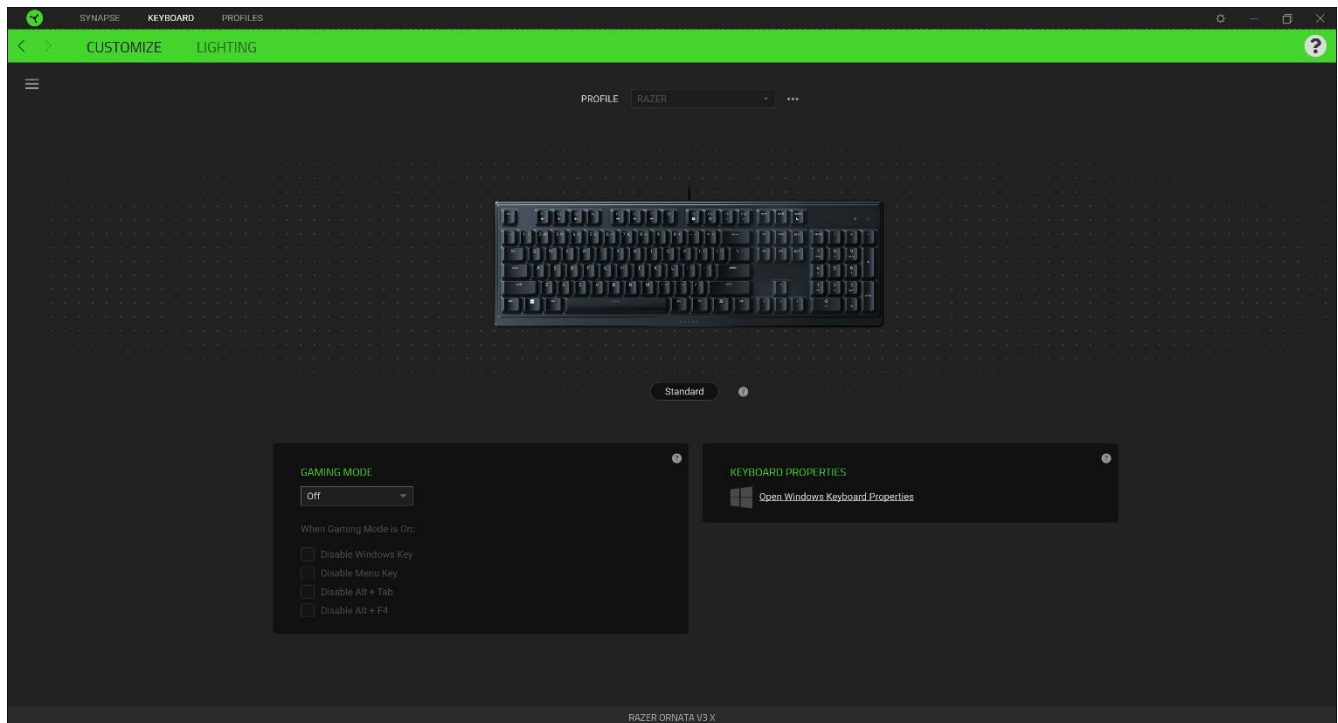

Profile

Profile is a data storage for keeping all your Razer peripheral's settings. By default, the profile name is based on your system's name. To add, import, rename, duplicate, export, or delete a profile, simply press the profile's corresponding Miscellaneous button (•••).

Keyboard Properties

Allows you to open the Windows Keyboard Properties where you can modify other keyboard settings such as Repeat delay, Repeat Rate, and Cursor blink rate, or view all keyboard drivers installed in your PC.

Hypershift

Hypershift mode is a secondary set of key assignments that is activated when the Hypershift key is held down. By default, the Hypershift key is assigned to the fn key of your Razer Synapse supported keyboard however, you can also assign any key as a Hypershift key.

Multi-Device Pairing

With the Razer Productivity USB dongle, you can pair an additional compatible device and use the same wireless USB dongle to control both devices.

Sidebar

Clicking the Sidebar button (☰) will reveal all current key assignments for your Razer Ornata V3 X.

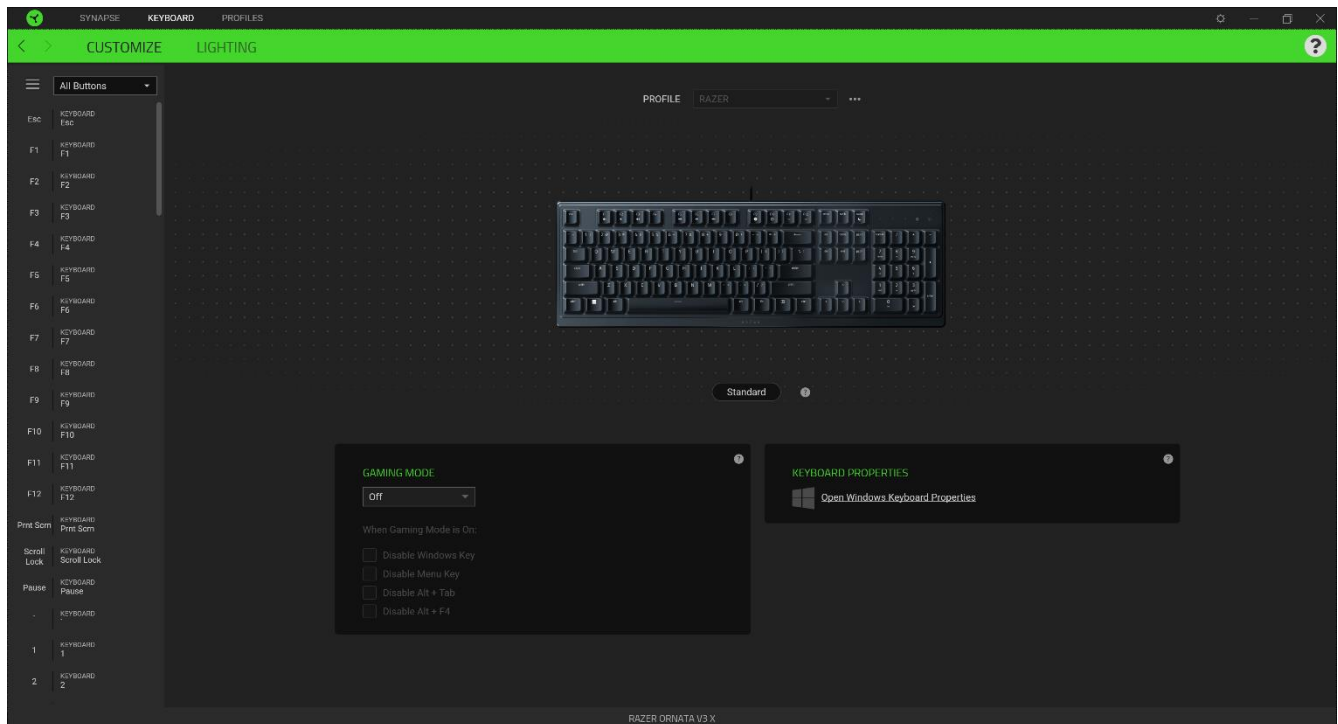

Alternatively, you can skip to a specific key assignment by selecting it on the Customize tab.

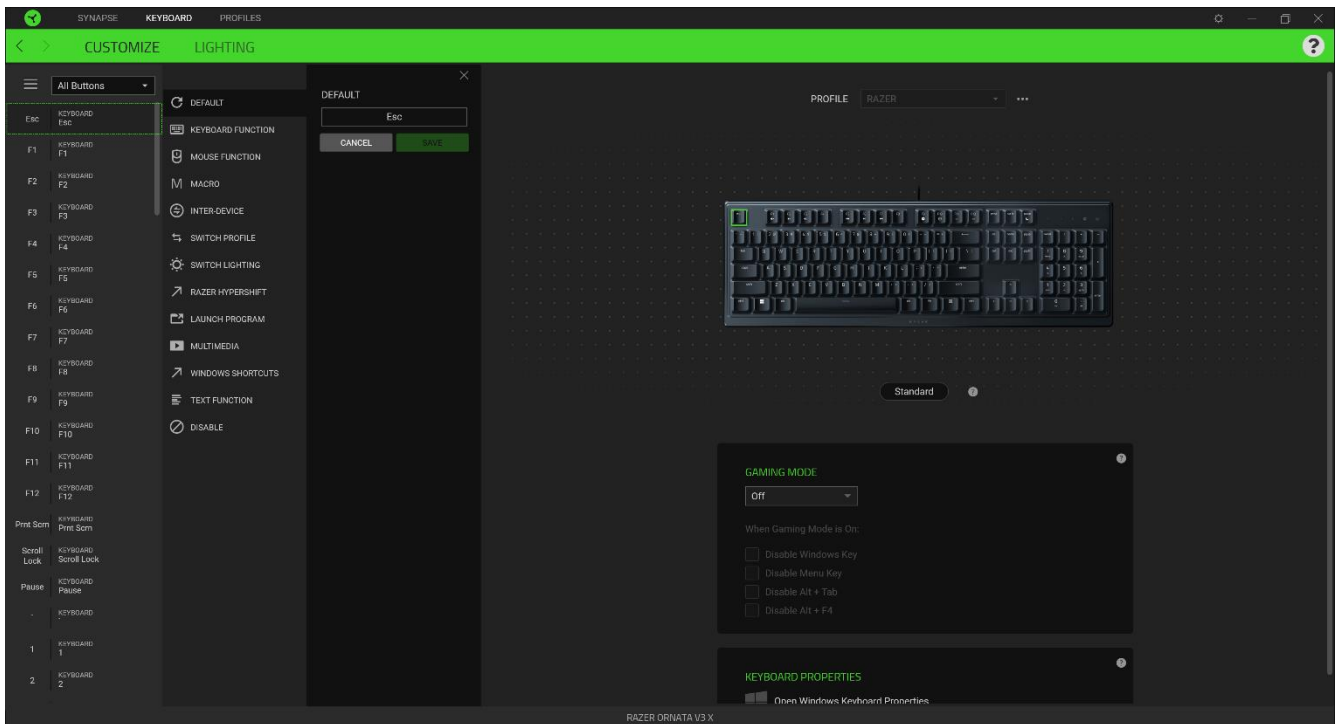

Upon selecting a key assignment, you may then change it to one of the following functions:

Default

This option enables you to return the selected key to its original setting.

Keyboard Function

This option changes the key assignment into a keyboard function. You can also choose enable Turbo mode which allows you to emulate repeatedly pressing the keyboard function while the key is held down.

Mouse Function

This option allows you to change any key into a mouse function. You can also choose to enable Turbo mode in some of the mouse functions to control how many times the function will be pressed while the key is held down.

Inter-device

Inter-device allows you to change the functionality of other Razer Synapse-enabled devices. Some of these functionalities are device-specific such as using your Razer gaming keyboard to change the Sensitivity Stage of your Razer gaming mouse.

M Macro

A Macro is a prerecorded sequence of keystrokes and button presses that is executed with precise timing. By setting the key function to Macro, you can conveniently execute a chain of commands. This function will only be visible when the Macro module is installed.

↔ Switch Profile

Switch Profile enables you to quickly change profiles and load a new set of key assignments. An on-screen notification will appear whenever you switch profiles.

⚙️ Switch Lighting

Switch Lighting allows you to easily switch between all advanced lighting effects. This function will only be visible when the Chroma Studio module is installed.

↗️ Razer Hypershift

Setting the key to Razer Hypershift will allow you to activate Hypershift mode if the key is held down.

🖱️ Launch Program

Launch Program enables you to open an app or a website using the assigned key. When you select Launch Program, two choices will appear which requires you to search for a specific app you want to open, or write the address of the website you want to visit.

▶️ Multimedia

This option allows you to assign multimedia controls to your Razer device.

↗️ Windows Shortcuts

This option allows you to assign your preferred key into a Windows Operating System shortcut command. For more information, please visit: support.microsoft.com/kb/126449

☰ Text Function

Text Function enables you to Type Ultra a prewritten text with a touch of a key. Simply write your desired text on the given field and your text will be Type Ultrad whenever the assigned key is pressed. This function has full Unicode support and you can also insert special symbols from character maps.

 Disable

This option renders the assigned key unusable. Use Disable if you do not want to use the selected key or if it interferes with your gaming.

Lighting

The Lighting subtab enables you to modify your Razer device's light settings.

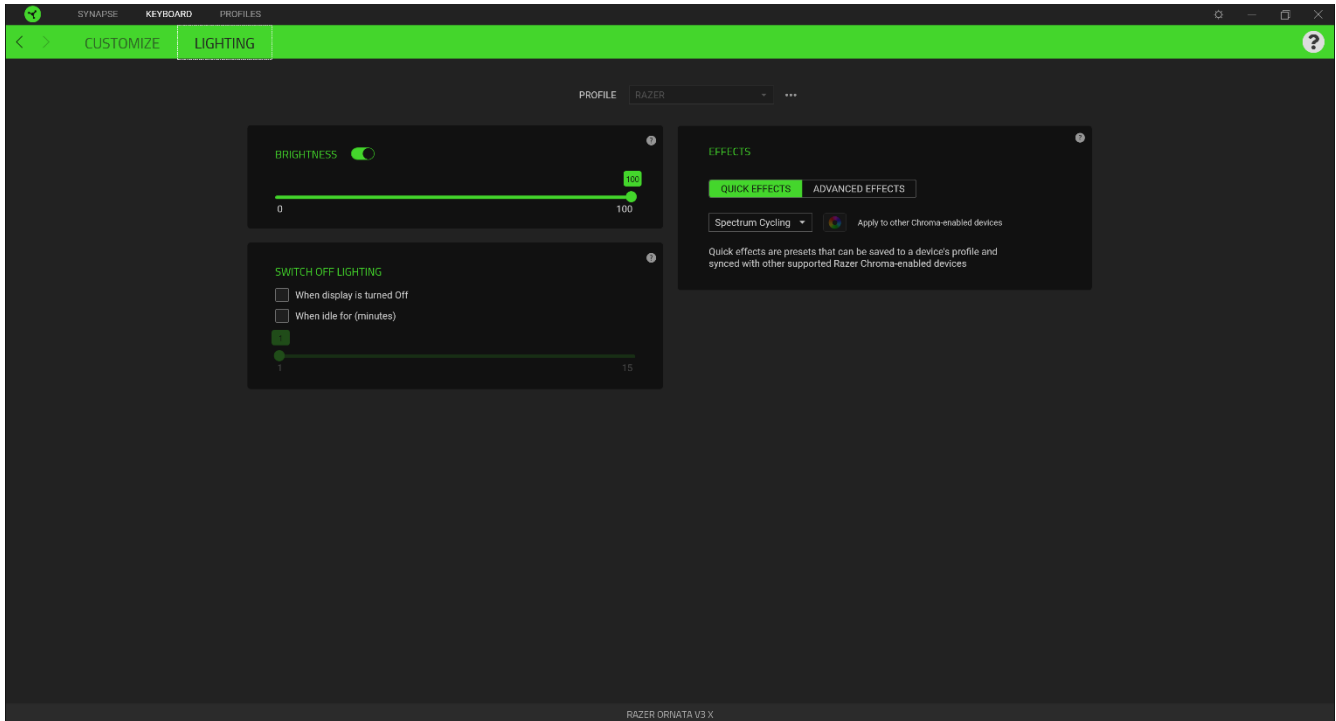

Brightness

You can turn off your Razer device's lighting by toggling the Brightness option or increase/decrease the luminance using the slider.







Switch Off Lighting

This is a power saving tool which allows you to disable your device's lighting in response to your system's display turning off and/or automatically power down when your Razer Ornata V3 X has been idle for a set amount of time.

Quick Effects

A number of quick effects can be selected and applied to your device's lighting, as listed here:

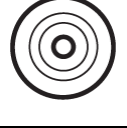
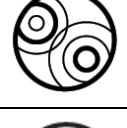
i Only devices that support the selected lighting effect will synchronize. LED indicators are not customizable.

	Name	Description	How to set up
	Ambient awareness	The lighting on the keyboard will reflect the averaged color on the selected screen region	Select or customize a screen region
	Audio meter	The keyboard will light up according to the audio level with a default spectrum of colors	Select a Color Boost level
	Breathing	The keyboard fades in and out of the selected color(s)	Select up to 2 colors or randomize colors
	Fire	The keyboard lights up in warm colors to mimic the motion of flames	No further customization required
	Reactive	The LEDs will light up when a key is pressed. The light will fade off after a specified period of time	Select a color and a duration
	Ripple	On key press, light will ripple away from the pressed key	Select a color
	Spectrum cycling	The lighting will cycle between 16.8 million colors indefinitely	No further customization required
	Starlight	Each LED will have a chance of fading in and out at a random time and duration	Select up to 2 colors or randomize colors and select a duration
	Static	The LEDs will remain lit in the selected color	Select a color
	Wave	The lighting will scroll in the direction selected	Select either left-to-right or right-to-left wave direction

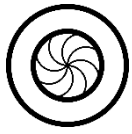

Wheel

The keyboard lighting will rotate in the direction selected with a default spectrum of colors

Select either counter-clockwise or clockwise wheel direction

If you have other supported Razer Chroma-enabled devices, you can synchronize their quick effects with your Razer device by clicking the Chroma Sync button ().

Studio Effects

The Studio Effects option allows you to choose a Chroma Effect you want to use on your Razer Chroma-enabled peripheral. To start making your own Chroma Effect, simply press the Chroma Studio button (). [Click here to learn more about the Chroma Studio](#)



PROFILES TAB

The Profiles tab is a convenient way of managing all your profiles and linking them to your games and applications.

Devices

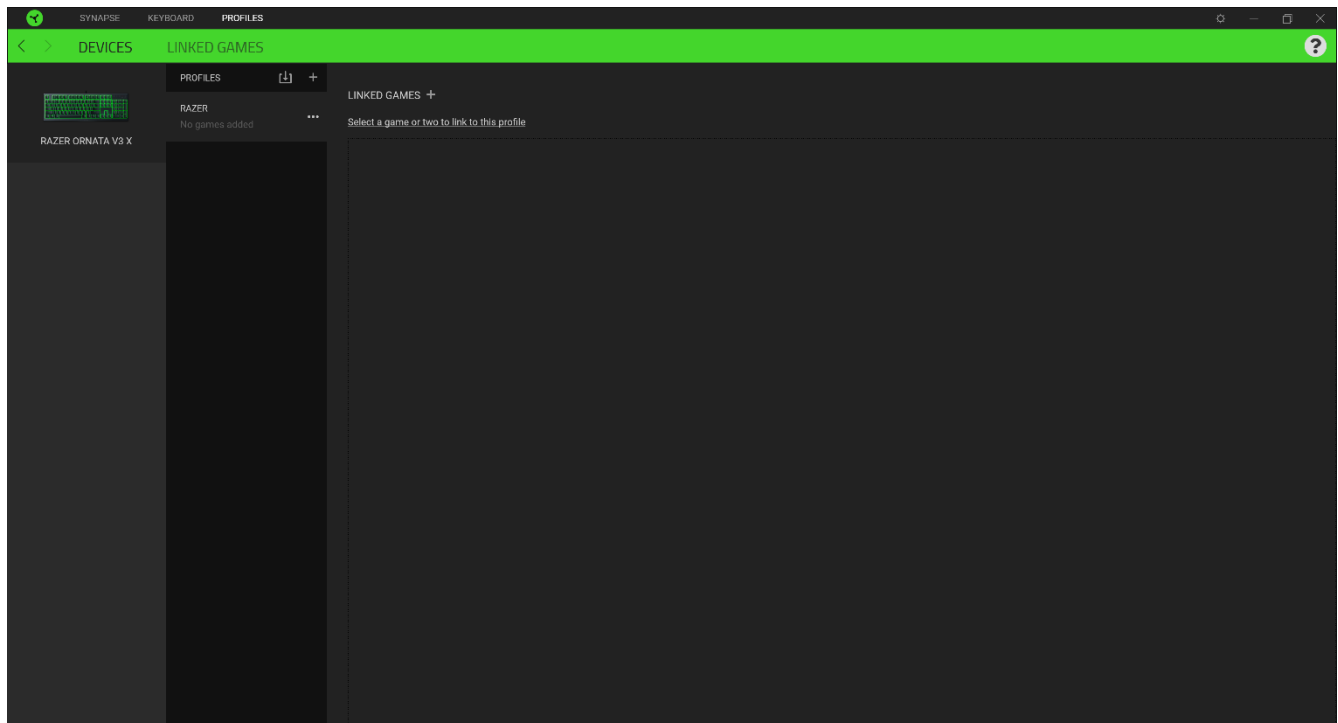
View which Razer device is using a specific profile using the Devices subtab.



You can import Profiles from your computer or from the cloud through the import button () or create new profiles within the selected device using the add button (). To rename, duplicate,

export, or delete a profile, simply press the Miscellaneous button (●●●). Each profile can be set to automatically activate when you run an application using the Linked Games option.

Linked Games

The Linked Games subtab gives you the flexibility to add games, view peripherals that are linked to games, or search for added games. You can also sort games based on alphabetical order, last played, or most played. Added games will still be listed here even if it is not linked to a Razer device.

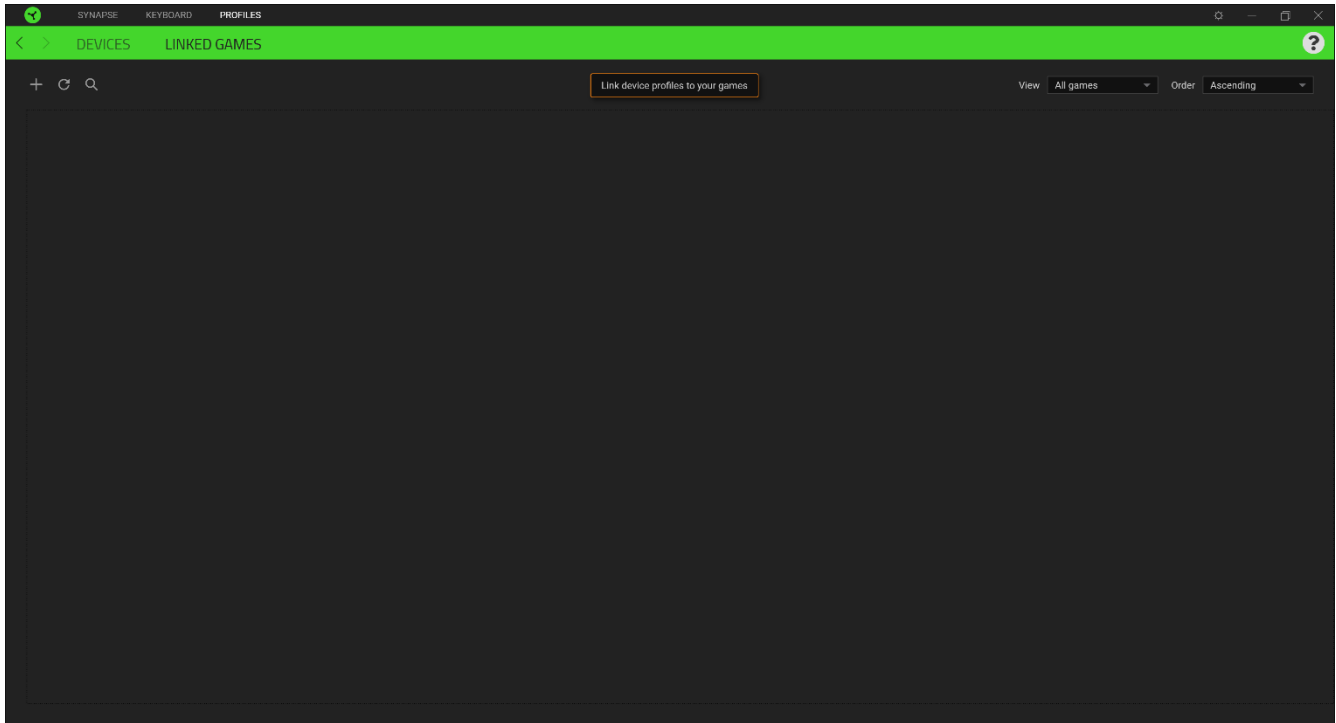

To link games to connected Razer devices, simply click on a game from the list, and then click **Select a device and its profile to launch automatically during gameplay** link to select the Razer device it will link with. Once linked, you may click on the Miscellaneous button (●●●) of the corresponding device to select a specific profile.

SETTINGS WINDOW

The Settings window, accessible by clicking the () button on Razer Synapse, enables you to configure the startup behavior and display language of Razer Synapse, view the master guides of each connected Razer device, or perform factory reset on any connected Razer device.

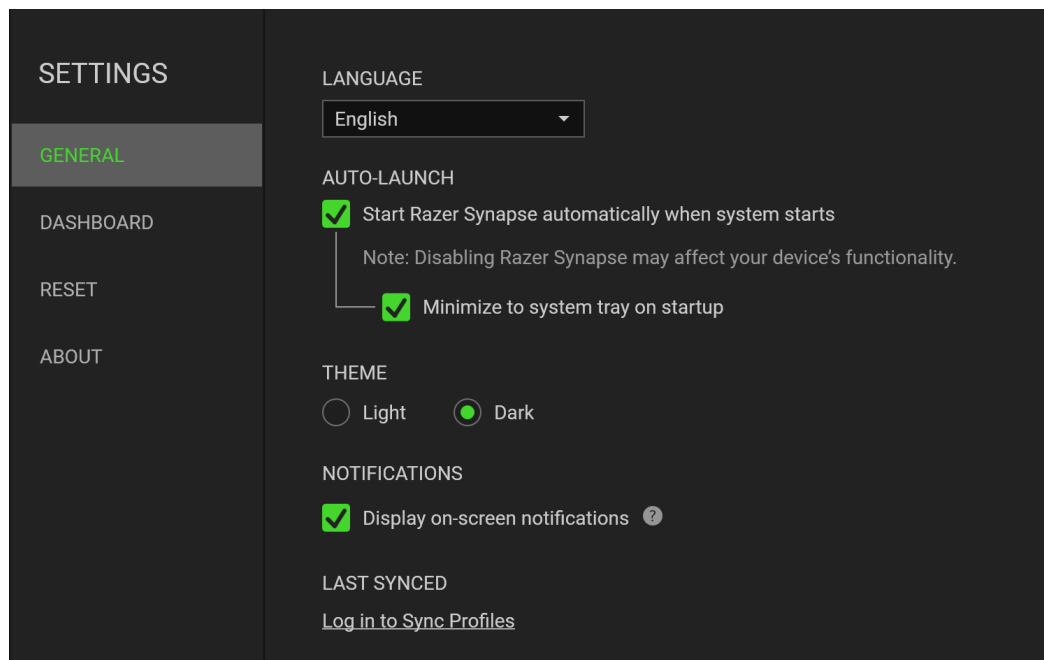

General tab

The default tab of the Settings window. The General tab enables you to change the software's display language, start-up behavior, and display theme. You may also manually sync your profiles to the cloud () or view the master guide of all connected Razer devices and installed modules.

Reset tab

The Reset tab allows you to perform a factory reset on any connected Razer device and/or reset Razer Synapse tutorials to acquaint yourself again with Razer Synapse's new features on its next launch.

 *By resetting a Razer device, all profiles on the selected device and its on-board memory (if present) will be erased.*

About tab

The About tab displays brief software information and copyright statement and provides relevant links for its terms of use. You may also use this tab to check for software updates, or as a quick access to Razer's social communities.

8. SAFETY AND MAINTENANCE

SAFETY GUIDELINES

In order to achieve maximum safety while using your Razer Ornata V3 X, we suggest that you adopt the following guidelines:

Should you have trouble operating the device properly and troubleshooting does not work, unplug the device and contact the Razer hotline or go to support.razer.com for assistance.

Don't take apart the device (doing so will void your warranty) and don't attempt to operate it under abnormal current loads.

Keep the device away from liquid, humidity or moisture. Operate the device only within the specific temperature range of 0°C (32°F) to 40°C (104°F). Should the temperature exceed this range, unplug and/or switch off the device in order to let the temperature stabilize to an optimal level.

COMFORT

Research has shown that long periods of repetitive motion, improper positioning of your computer peripherals, incorrect body position, and poor habits may be associated with physical discomfort and injury to nerves, tendons, and muscles. Below are some guidelines to avoid injury and ensure optimum comfort while using your Razer Ornata V3 X.

1. Position your keyboard and monitor directly in front of you with your mouse next to it. Place your elbows next to your side, not too far away and your keyboard within easy reach.
2. Adjust the height of your chair and table so that the keyboard and mouse are at or below elbow height.
3. Keep your feet well supported, posture straight and your shoulders relaxed.
4. During gameplay, relax your wrist and keep it straight. If you do the same tasks with your hands repeatedly, try not to bend, extend or twist your hands for long periods.
5. Don't rest your wrists on hard surfaces for long periods.
6. Use a wrist rest to support your wrist while gaming.
7. Customize the keys on your keyboard to suit your style of gaming in order to minimize repetitive or awkward motions while gaming.
8. Don't sit in the same position all day. Get up, step away from your desk and do exercises to stretch your arms, shoulders, neck and legs.

If you should experience any physical discomfort while using your keyboard, such as pain, numbness, or tingling in your hands, wrists, elbows, shoulders, neck or back, please consult a qualified medical doctor immediately.

MAINTENANCE AND USE

The Razer Ornata V3 X requires minimum maintenance to keep it in optimum condition. Once a month we recommend you switch off, unplug the device from the computer, and clean it using a soft cloth or cotton swab to prevent dirt buildup. Don't use soap or harsh cleaning agents.

9. LEGALESE

COPYRIGHT AND INTELLECTUAL PROPERTY INFORMATION

©2022 Razer Inc. All rights reserved. Razer, the triple-headed snake logo, Razer logo, and “For Gamers. By Gamers.”, are trademarks or registered trademarks of Razer Inc. and/or affiliated companies in the United States or other countries. All other trademarks are the property of their respective owners.

Windows and the Windows logo are trademarks of the Microsoft group of companies.

Razer Inc. (“Razer”) may have copyright, trademarks, trade secrets, patents, patent applications, or other intellectual property rights (whether registered or unregistered) concerning the product in this guide. Furnishing of this guide does not give you a license to any such copyright, trademark, patent or other intellectual property right. The Razer Ornata V3 X (the “Product”) may differ from pictures whether on packaging or otherwise. Razer assumes no responsibility for such differences or for any errors that may appear. Information contained herein is subject to change without notice.

LIMITED PRODUCT WARRANTY

For the latest and current terms of the Limited Product Warranty, please visit razer.com/warranty.

LIMITATION OF LIABILITY

Razer shall in no event be liable for any lost profits, loss of information or data, special, incidental, indirect, punitive or consequential or incidental damages, arising in any way out of distribution of, sale of, resale of, use of, or inability to use the Product. In no event shall Razer’s liability exceed the retail purchase price of the Product.

GENERAL

These terms shall be governed by and construed under the laws of the jurisdiction in which the Product was purchased. If any term herein is held to be invalid or unenforceable, then such term (in so far as it is invalid or unenforceable) shall be given no effect and deemed to be excluded without invalidating any of the remaining terms. Razer reserves the right to amend any term at any time without notice.