



REPUBLIC OF
GAMERS

ROG STRIX
XG32VC
CURVED GAMING MONITOR

ASUS

Table of contents

| | |
|---|------|
| Notices | iii |
| Safety information | iv |
| Care & Cleaning | viii |
| 1.1 Welcome | 1-2 |
| 1.2 Package contents..... | 1-2 |
| 1.3 Assembling the monitor..... | 1-3 |
| 1.4 Connect cables..... | 1-4 |
| 1.4.1 Rear of the LCD monitor | 1-4 |
| 1.5 Monitor introduction | 1-5 |
| 1.5.1 Using the Controls button | 1-5 |
| 2.1 Adjusting the monitor..... | 2-1 |
| 2.2 Outline dimension..... | 2-2 |
| 2.3 Detaching the arm/stand (for VESA wall mount) | 2-3 |
| 3.1 OSD (On-Screen Display) menu | 3-1 |
| 3.1.1 How to reconfigure..... | 3-1 |
| 3.1.2 OSD Function Introduction..... | 3-2 |
| 3.2 Specifications..... | 3-10 |
| 3.3 Troubleshooting (FAQ)..... | 3-11 |
| 3.4 Supported Timing List..... | 3-12 |

Copyright © 2020 ASUSTeK COMPUTER INC. All Rights Reserved.

No part of this manual, including the products and software described in it, may be reproduced, transmitted, transcribed, stored in a retrieval system, or translated into any language in any form or by any means, except documentation kept by the purchaser for backup purposes, without the express written permission of ASUSTeK COMPUTER INC. ("ASUS").

Product warranty or service will not be extended if: (1) the product is repaired, modified or altered, unless such repair, modification or alteration is authorized in writing by ASUS; or (2) the serial number of the product is defaced or missing.

ASUS PROVIDES THIS MANUAL "AS IS" WITHOUT WARRANTY OF ANY KIND, EITHER EXPRESS OR IMPLIED, INCLUDING BUT NOT LIMITED TO THE IMPLIED WARRANTIES OR CONDITIONS OF MERCHANTABILITY OR FITNESS FOR A PARTICULAR PURPOSE. IN NO EVENT SHALL ASUS, ITS DIRECTORS, OFFICERS, EMPLOYEES OR AGENTS BE LIABLE FOR ANY INDIRECT, SPECIAL, INCIDENTAL, OR CONSEQUENTIAL DAMAGES (INCLUDING DAMAGES FOR LOSS OF PROFITS, LOSS OF BUSINESS, LOSS OF USE OR DATA, INTERRUPTION OF BUSINESS AND THE LIKE), EVEN IF ASUS HAS BEEN ADVISED OF THE POSSIBILITY OF SUCH DAMAGES ARISING FROM ANY DEFECT OR ERROR IN THIS MANUAL OR PRODUCT.

SPECIFICATIONS AND INFORMATION CONTAINED IN THIS MANUAL ARE FURNISHED FOR INFORMATIONAL USE ONLY, AND ARE SUBJECT TO CHANGE AT ANY TIME WITHOUT NOTICE, AND SHOULD NOT BE CONSTRUED AS A COMMITMENT BY ASUS. ASUS ASSUMES NO RESPONSIBILITY OR LIABILITY FOR ANY ERRORS OR INACCURACIES THAT MAY APPEAR IN THIS MANUAL, INCLUDING THE PRODUCTS AND SOFTWARE DESCRIBED IN IT.

Products and corporate names appearing in this manual may or may not be registered trademarks or copyrights of their respective companies, and are used only for identification or explanation and to the owners' benefit, without intent to infringe.

Notices

Federal Communications Commission Statement

This device complies with Part 15 of the FCC Rules. Operation is subject to the following two conditions:

- This device may not cause harmful interference.
- This device must accept any interference received including interference that may cause undesired operation.

This equipment has been tested and found to comply with the limits for a Class B digital device, pursuant to Part 15 of the FCC Rules. These limits are designed to provide reasonable protection against harmful interference in a residential installation. This equipment generates, uses and can radiate radio frequency energy and, if not installed and used in accordance with the instructions, may cause harmful interference to radio communications. However, there is no guarantee that interference will not occur in a particular installation. If this equipment does cause harmful interference to radio or television reception, which can be determined by turning the equipment off and on, the user is encouraged to try to correct the interference by one or more of the following measures:

- Reorient or relocate the receiving antenna.
- Increase the separation between the equipment and receiver.
- Connect the equipment to an outlet on a circuit different from that to which the receiver is connected.
- Consult the dealer or an experienced radio/TV technician for help.



The use of shielded cables for connection of the monitor to the graphics card is required to assure compliance with FCC regulations. Changes or modifications to this unit not expressly approved by the party responsible for compliance could void the user's authority to operate this equipment.

Canadian Department of Communications Statement

This digital apparatus does not exceed the Class B limits for radio noise emissions from digital apparatus set out in the Radio Interference Regulations of the Canadian Department of Communications.

This class B digital apparatus complies with Canadian ICES-003.

This Class B digital apparatus meets all requirements of the Canadian Interference-Causing Equipment Regulations.

Cet appareil numérique de la classe B respecte toutes les exigences du Règlement sur le matériel brouiller du Canada.

Safety information

- Before setting up the monitor, carefully read all the documentation that came with the package.
- To prevent fire or shock hazard, never expose the monitor to rain or moisture.
- Never try to open the monitor cabinet. The dangerous high voltages inside the monitor may result in serious physical injury.
- If the power supply is broken, do not try to fix it by yourself. Contact a qualified service technician or your retailer.
- Before using the product, make sure all cables are correctly connected and the power cables are not damaged. If you detect any damage, contact your dealer immediately.
- Slots and openings on the back or top of the cabinet are provided for ventilation. Do not block these slots. Never place this product near or over a radiator or heat source unless proper ventilation is provided.
- The monitor should be operated only from the type of power source indicated on the label. If you are not sure of the type of power supply to your home, consult your dealer or local power company.
- Use the appropriate power plug which complies with your local power standard.
- Do not overload power strips and extension cords. Overloading can result in fire or electric shock.
- Avoid dust, humidity, and temperature extremes. Do not place the monitor in any area where it may become wet. Place the monitor on a stable surface.
- Unplug the unit during a lightning storm or if it will not be used for a long period of time. This will protect the monitor from damage due to power surges.
- Never push objects or spill liquid of any kind into the slots on the monitor cabinet.
- To ensure satisfactory operation, use the monitor only with UL listed computers which have appropriate configured receptacles marked between 100 ~ 240V AC.
- The socket-outlet shall be installed near the equipment and shall be easily accessible
- If you encounter technical problems with the monitor, contact a qualified servicer.
- Provide an earthing connection before the mains plug is connected to the mains. And, when disconnecting the earthing connection, be sure to disconnect after pulling out the mains plug from the mains.
- Please use ADP-90LE BA adapter.

- Please confirm the distribution system in building installation shall provide the circuit breaker rated 120/240V, 20A (maximum).
- If provided with a 3-pin attachment plug on the power cord, plug the cord into a grounded (earthed) 3-pin outlet. Do not disable the power cord grounding pin, for example, by attaching a 2-pin adapter. The grounding pin is an important safety feature.
- **Stability Hazard.** The product may fall, causing serious personal injury or death. To prevent injury, this product must be securely attached to the floor/wall in accordance with the installation instructions. A product may fall, causing serious personal injury or death. Many injuries, particularly to children, can be avoided by taking simple precautions such as: ALWAYS use cabinets or stands or installation methods recommended by the manufacturer of the product set. ALWAYS use furniture that can safely support the product. ALWAYS ensure the product is not overhanging the edge of the supporting furniture. ALWAYS educate children about the dangers of climbing on furniture to reach the product or its controls. ALWAYS route cords and cables connected to your product so they cannot be tripped over, pulled or grabbed. NEVER place a product in an unstable location. NEVER place the product on tall furniture (for example, cupboards or bookcases) without anchoring both the furniture and the product to a suitable support. NEVER place the product on cloth or other materials that may be located between the product and supporting furniture. NEVER place items that might tempt children to climb, such as toys and remote controls, on the top of the product or furniture on which the product is placed. If the existing product is going to be retained and relocated, the same considerations as above should be applied.

Stability Hazard

- The product may fall, causing serious personal injury or death. To prevent injury, this product must be securely attached to the floor/wall in accordance with the installation instructions.
- A product may fall, causing serious personal injury or death. Many injuries, particularly to children, can be avoided by taking simple precautions such as:
- ALWAYS use cabinets or stands or installation methods recommended by the manufacturer of the product set.
- ALWAYS use furniture that can safely support the product.
- ALWAYS ensure the product is not overhanging the edge of the supporting furniture.
- ALWAYS educate children about the dangers of climbing on furniture to reach the product or its controls.
- ALWAYS route cords and cables connected to your product so they cannot be tripped over, pulled or grabbed.
- NEVER place a product in an unstable location.

- NEVER place the product on tall furniture (for example, cupboards or bookcases) without anchoring both the furniture and the product to a suitable support.
- NEVER place the product on cloth or other materials that may be located between the product and supporting furniture.
- NEVER place items that might tempt children to climb, such as toys and remote controls, on the top of the product or furniture on which the product is placed.
- If the existing product is going to be retained and relocated, the same considerations as above should be applied.

WARNING

Usage of other than specified head- or earphones can result in hearing loss due to excessive sound pressures.

Restriction on Hazardous Substances statement (India)

This product complies with the “India E-Waste (Management) Rules, 2016” and prohibits use of Lead, Mercury, Hexavalent Chromium, polybrominated biphenyls(PBBs) and polybrominated diphenyl ethers(PBDEs) in concentration exceeding 0.1% by weight in homogenous materials and 0.01% by weight in homogenous materials for cadmium, except of exemptions listed in Schedule 2 of the Rule.

HDMI™
HIGH-DEFINITION MULTIMEDIA INTERFACE

EAC

Prevent Tipping

When using the display, fasten the LCD to a wall using a cord or chain that can support the weight of the monitor in order to prevent the monitor from falling.

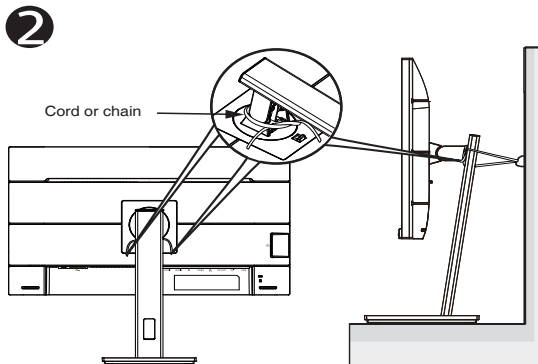
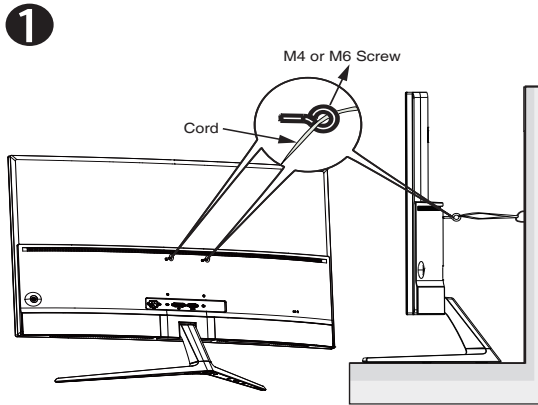

- Display design may differ from those illustrated.
- Installing must be done by a qualified technician, and please contact your supplier for more information.
- For the Models with net weight $\geq 7\text{kg}$. Please select the suitable way to Prevent Tipping.
- For the models with VESA Mount, please use method **1**, install the screws with ring to the VESA Mount hole, then tie the cord or chain to the wall. Otherwise, please use method **2** to tie the cord or chain to the stand and then fix it to the wall.

Care & Cleaning

- Before you lift or reposition your monitor, it is better to disconnect the cables and power cord. Follow the correct lifting techniques when positioning the monitor. When lifting or carrying the monitor, grasp the edges of the monitor. Do not lift the display by the stand or the cord.
- Cleaning. Turn your monitor off and unplug the power cord. Clean the monitor surface with a lint-free, non-abrasive cloth. Stubborn stains may be removed with a cloth dampened with mild cleaner.
- Avoid using a cleaner containing alcohol or acetone. Use a cleaner intended for use with the LCD. Never spray cleaner directly on the screen, as it may drip inside the monitor and cause an electric shock.



This symbol of the crossed out wheeled bin indicates that the product (electrical, electronic equipment, and mercury-containing button cell battery) should not be placed in municipal waste.

Please check local regulations for disposal of electronic products.

AAAA yönetmeliğine uygundur

The following symptoms are normal with the monitor:

- The screen may flicker during the initial use due to the nature of the fluorescent light. Turn off the Power Switch and turn it on again to make sure that the flicker disappears.
- You may find slightly uneven brightness on the screen depending on the desktop pattern you use.
- When the same image is displayed for hours, an afterimage of the previous screen may remain after switching the image. The screen will recover slowly or you can turn off the Power Switch for hours.
- When the screen becomes black or flashes, or cannot work anymore, contact your dealer or service center to fix it. Do not repair the screen by yourself!

Conventions used in this guide



WARNING: Information to prevent injury to yourself when trying to complete a task.



CAUTION: Information to prevent damage to the components when trying to complete a task.



IMPORTANT: Information that you **MUST** follow to complete a task.



NOTE: Tips and additional information to aid in completing a task.

Where to find more information

Refer to the following sources for additional information and for product and software updates.

1. ASUS websites

The ASUS websites worldwide provide updated information on ASUS hardware and software products. Refer to **<http://www.asus.com>**

2. Optional documentation

Your product package may include optional documentation that may have been added by your dealer. These documents are not part of the standard package.

1.1 Welcome

Thank you for purchasing the ASUS® LCD monitor!

The latest widescreen LCD monitor from ASUS provides a crisper, broader, and brighter display, plus a host of features that enhance your viewing experience.

With these features, you can enjoy the convenience and delightful visual experience that the monitor brings you!

1.2 Package contents

Check your package for the following items:

- ✓ LCD Monitor
- ✓ Monitor Base
- ✓ Quick Start Guide
- ✓ Warranty Card
- ✓ 1x Power Cord
- ✓ 1x HDMI Cable
- ✓ 1x DP Cable
- ✓ 1x Power Adapter
- ✓ 1x USB 3.0 Cable
- ✓ 1x USB-C Cable
- ✓ ROG Sticker



-
- If any of the above items is damaged or missing, contact your retailer immediately.
-

1.3 Assembling the monitor

To assemble the monitor:



- **While assembling the monitor arm/base, we recommend that you keep the monitor inside its EPS (Expanded Polystyrene) packaging.**
-

1. Align the screw hole on the arm with the bundled screw on the base. Then insert the base into the arm.
2. Fix the base to the arm by fastening the bundled screw.
3. Remove the monitor from its EPS packaging. Adjust the monitor to the angle that is most comfortable for you.

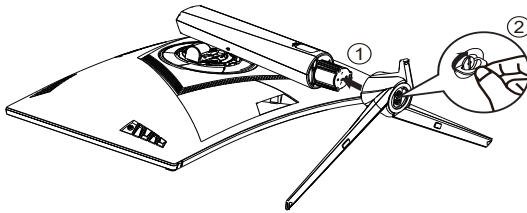

1.4 Connect cables

1.4.1 Rear of the LCD monitor

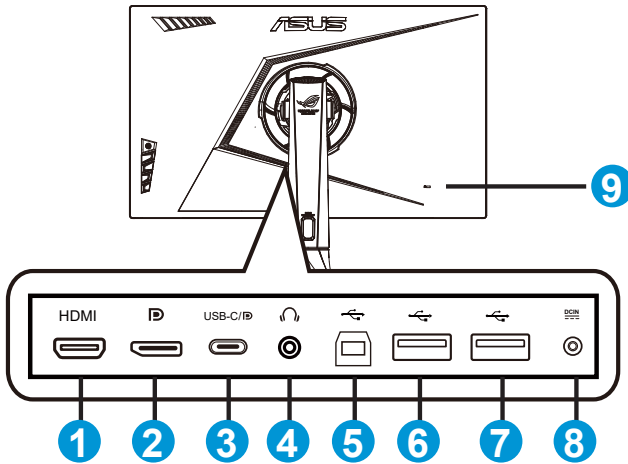

1. HDMI Port
2. DisplayPort
3. USB C/DP Port (PD 5V/2A)
4. Earphone Jack
5. USB3.0 Upstream Port
6. USB3.0 Downstream Port
7. USB3.0 Downstream Port
8. DC-IN Port
9. Kensington Lock

1.5 Monitor introduction

1.5.1 Using the Controls button

Use the control button on the back of the monitor to adjust the monitor settings.

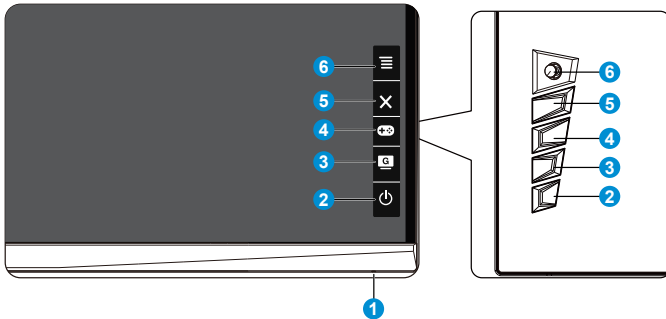

1. Power Indicator:

- The color definition of the power indicator is as the below table.

| Status | Description |
|--------|--------------|
| White | ON |
| Amber | Standby mode |
| OFF | OFF |

2.  Power Button:

- Press this button to turn the monitor on/off. Press any key to turn on the monitor when monitor is power off.







3.  GameVisual:

- Press this hotkey to switch from eight video preset modes (Scenery Mode, Racing Mode, Cinema Mode, RTS/RPG Mode, FPS Mode, sRGB Mode, MOBA Mode and User Mode) with GameVisual™ Video Intelligence Technology.

4.  GamePlus:

- GamePlus: The GamePlus Function provides a toolkit and creates a better gaming environment for users when playing different types of games. Particularly, Crosshair function is specially designed for new gamers or beginners interested in First Person Shooter (FPS) games.

To active GamePlus:

- Press **GamePlus** Button to enter the GamePlus main menu.
- Activate Crosshair, Timer, FPS Counter or Display Alignment function.
- Move the   button up/down to select and press   to confirm the function needed. Press  to go off, and exit.
- Crosshair/Timer/FPS Counter is movable by pressing  5-way key.

GamePlus main menu

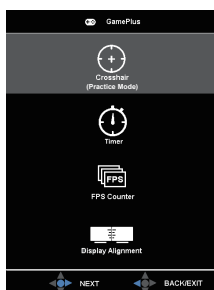

GamePlus-Crosshair

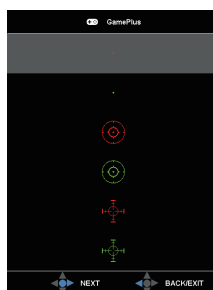



GamePlus-Timer

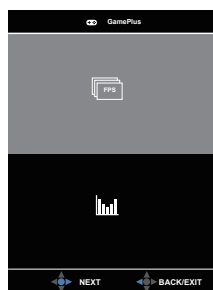

GamePlus-FPS Counter



5.  Close Button:
 - Exit the OSD menu.
6.   5-way) Button:
 - Turn on the OSD menu. Enacts the selected OSD menu item.
 - Increases/Decreases values or moves your selection up/down/left/right.

2.1 Adjusting the monitor

- For optimal viewing, we recommend that you look at the full face of the monitor, then adjust the monitor to the angle that is most comfortable for you.
- Hold the stand to prevent the monitor from falling when you change its angle.
- You can adjust the monitor's angle from -3.5° to 18.5° and it allows 26° swivel adjustment from either left or right. You can also adjust the monitor's height within ± 10 cm.

$-3.5^{\circ} \sim 18.5^{\circ}$
↔

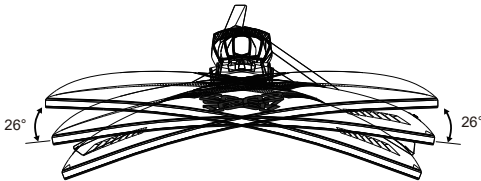
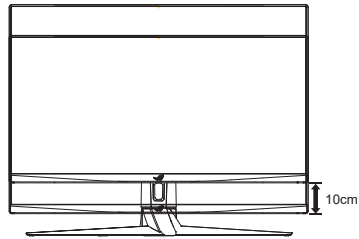
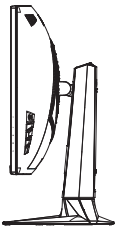

It is normal that the monitor slightly shakes while you adjust the viewing angle.

2.2 Outline dimension

Unit: mm [inch]

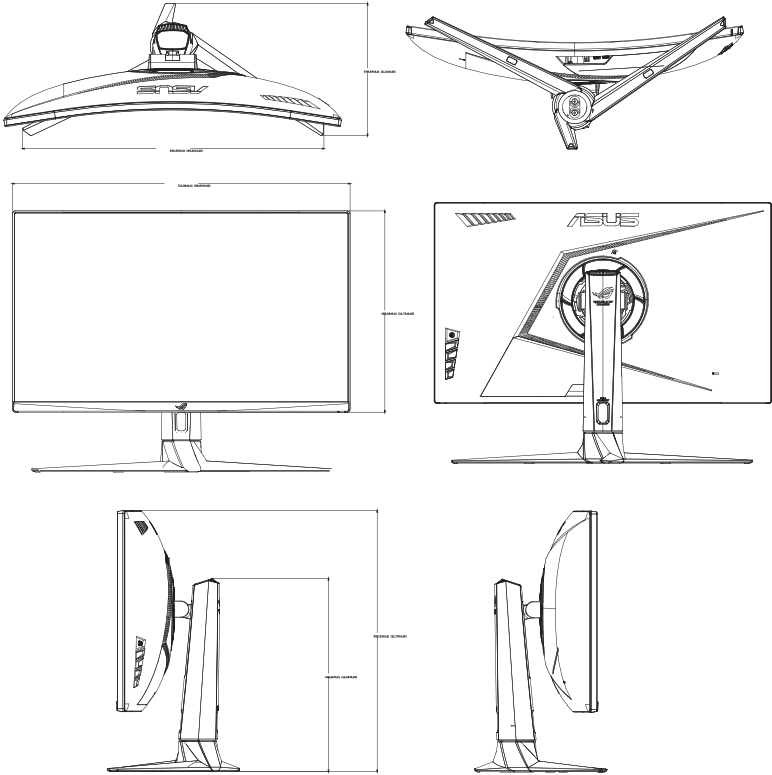

2.3 Detaching the arm/stand (for VESA wall mount)



- Avoid damaging the monitor surface. While detaching the monitor stand, always keep the monitor inside its EPS packaging.

The detachable stand of this monitor is specially designed for VESA wall mount.

To detach the arm/stand

1. Disconnect power and signal cables. Carefully put the monitor facedown on its EPS packaging.
2. Remove the covers on where the monitor and the arm meet.
3. Remove the four (4) screws securing the arm to the rear of the monitor.
4. Detach the stand (arm and base) from the monitor.

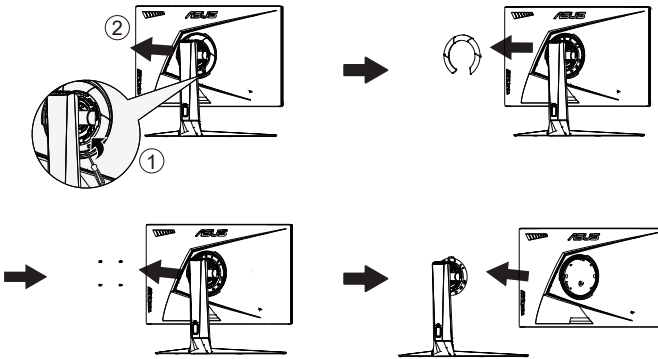

- Use only the UL Listed Wall Mount Bracket with minimum weight/load 28.8 kg (Screw size: M4 x 10 mm).

3.1 OSD (On-Screen Display) menu

3.1.1 How to reconfigure

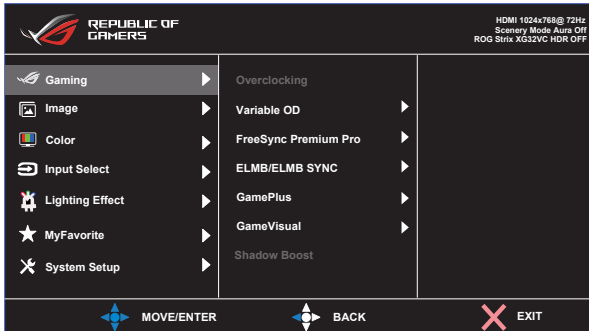

1. Press the Central of 5-way button to display the OSD menu.
2. Press the Up and Down keys to switch the options in the menu. When you move from one icon to another, the option name is highlighted.
3. To select a highlighted item from the menu, press the Right key or the Central button.
4. Press the Up and Down keys to select the desired parameters.
5. Press the Right key or the Central button to enter the slide bar, and then use the Up or Down keys (depending on the indicators in the menu) to make changes.
6. Press the Left key to return to the previous menu.

3.1.2 OSD Function Introduction

1. Gaming

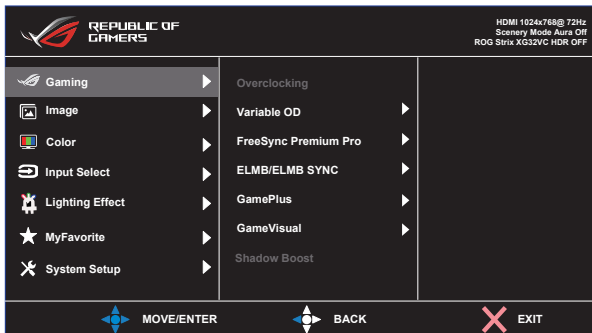

- **Overclocking:** This function allows you to adjust the refresh rate.
- **Variable OD:** Speeds up the response time by Over Drive technology. Including Level 0~Level 5.
- **FreeSync Premium Pro:** It can allow a FreeSync Premium Pro supported graphics source to dynamically adjust display refresh rate based on typical content frame rates for power efficient, virtually stutter free and low-latency display update.
- **ELMB:** Check to decrease motion blur and minimize ghosting part when on-screen objects are fast moving. ELMB is disabled if input V frequency less than 85Hz.
- **ELMB SYNC:** ELMB SYNC on support when adaptive sync work.
- **GamePlus:** The GamePlus Function provides a toolkit and creates a better gaming environment for users when playing different types of games. Particularly, Crosshair function is specially designed for new gamers or beginners interested in First Person Shooter (FPS) games.
- **GameVisual:** This function contains eight sub-functions that you can select for your preference.
- **Shadow Boost :** Dark color enhancement adjust monitor gamma curve to enrich the dark tones in an image making dark scenes and objects much easier be found.



-
- In the Racing Mode, the Saturation, and ASCR functions are not user-configurable.
 - In the sRGB Mode, the Saturation, Skin Tone, Color Temp., Brightness, Contrast and ASCR functions are not user-configurable.
 - In the MOBA Mode, the Saturation and ASCR functions are not user-configurable.
-

2. Image

You can adjust Brightness, Contrast, HDR, VividPixel ,ASCR, Aspect Control and Blue Light Filter from this main function.

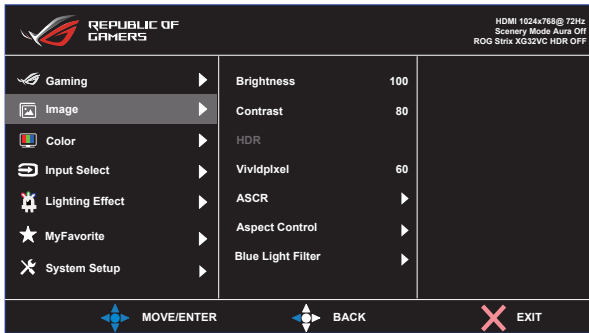

- **Brightness:** The adjusting range is from 0 to 100.
- **Contrast:** The adjusting range is from 0 to 100.
- **HDR:** High Dynamic Range. Contains three HDR modes (ASUS Cinema HDR, ASUS Gaming HDR and Console Mode). HDR item will be locked when connected to AMD FreeSync2 HDR video.
- **Vividpixel:** ASUS Exclusive Technology that brings lifelike visuals for crystal-clear and detail-oriented enjoyment. The adjusting range is from 0 to 100.
- **ASCR:** Select **ON** or **OFF** to enable or disable dynamic contrast ratio function.
- **Aspect Control:** Adjusts the aspect ratio to “Full” , **4:3**, **16:9 (24”W)** and **16:9 (27”W)**.
- **Blue Light Filter:** Adjust the energy level of blue light emitted from LED backlight.



-
- Choose 4:3 to display the picture according to the original aspect ratio of the input source.
-



- When Blue Light Filter is activated, the default settings of Racing Mode will be automatically imported.
- Between Level 1 to Level 3, the Brightness function is user-configurable.
- Level 4 is optimized setting. It is compliance with TUV Low Blue Light Certification. The Brightness function is not user-configurable.



Please refer to the following to alleviate eye strains:

- Users should take some time away from the display if working for long hours. It is advised to take short breaks (at least 5 mins) after around 1 hour of continuous working at the computer. Taking short and frequent breaks is more effective than a single longer break.
 - To minimize eye strain and dryness in your eyes, users should rest the eye periodically by focusing on objects that are far away.
 - Eye exercises can help to reduce eye strain. Repeat these exercises often. If eye strain continues please consult a physician. Eye exercises: (1) Repeating look up and down (2) Slowly roll your eyes (3) Move your eyes diagonal.
 - High energy blue light may lead to eye strain and AMD (Age-Related Macular Degeneration). Blue light filter to reduce 70% (max.) harmful blue light to avoiding CVS (Computer Vision Syndrome).
-

3. Color

Select the image color you like from this function.

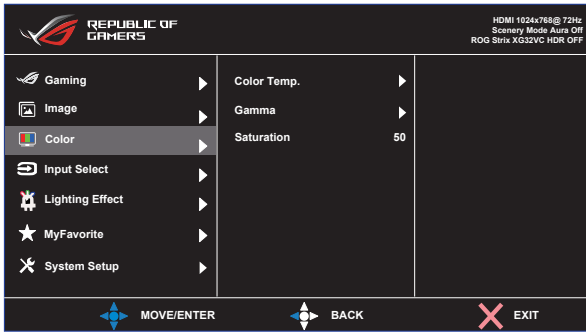

- **Color Temp.:** Contains three preset color modes (**Cool**, **Normal**, **Warm**) and **User Mode**.
- **Gamma:** Contains three gamma modes including 1.8, 2.2, 2.5.
- **Saturation:** The adjusting range is from 0 to 100.



-
- In the **User Mode**, colors of R (Red), G (Green), and B (Blue) are user-configurable; the adjusting range is from 0 ~ 100.
-

4. Input Select

Select the input source:

- HDMI, DisplayPort, and Type-C

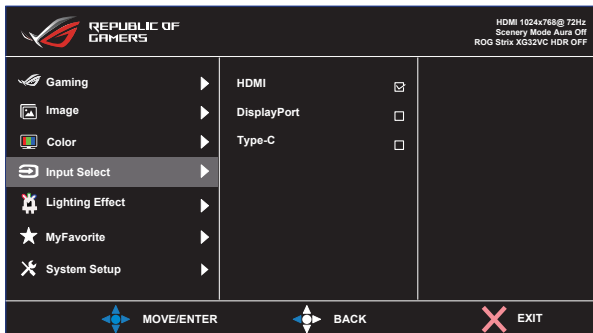

5. Lighting Effect

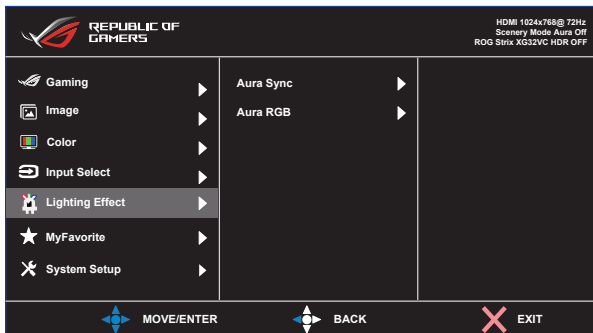

- **Aura Sync:** Allows you to turn on or off the Aura Sync function that synchronizes the Aura RGB light effect among all supported devices.
- **Aura RGB:** In this function you can select an Aura RGB light effect for the monitor and change settings for the light effect. Select “OFF” if you want to turn the Aura RGB light effect off.



- If the Aura Sync function is turned ON, the Aura RGB function will become unavailable.
- See section 3.2 for information on how to customize Aura light effects from your computer.

6. MyFavorite

You can adjust Shortcut and Customized Setting from this main function.

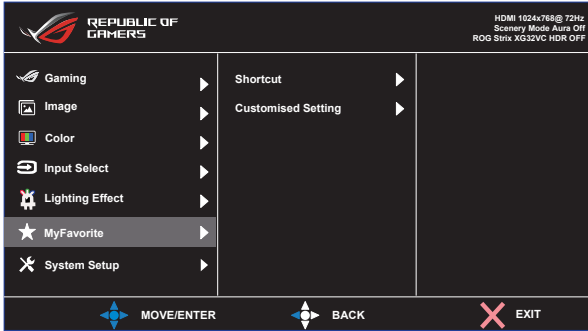

- **Shortcut:** User can select from “GamePlus, GameVisual, Brightness, Contrast, Input Select, HDR, Blue Light Filter, Color Temp., Volume, KVM, MyFavorite-1 (Load), MyFavorite-2 (Load)” and set as shortcut key.
- **Customized Setting:** You can do your setting according to your favorite.

7. System Setup

Adjusts the system configuration.

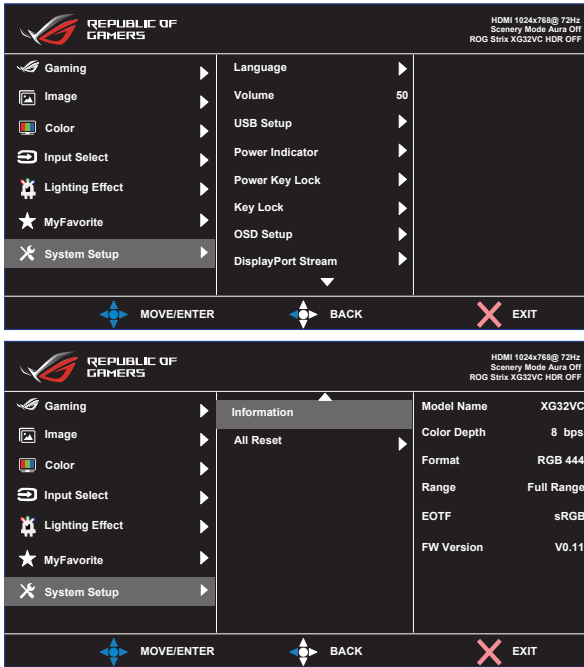

- **Language:** Select OSD language. The selections are: **English, French, German, Spanish, Italian, Dutch, Russian, Poland, Czech, Croacia, Hungary, Romania, Portugal, Turkey, Simplified Chinese, Traditional Chinese, Japanese, Korean, Persian, Thai, and Indonesian.**
- **Volume:** adjust the output volume level.
- **KVM:** Switch USB3.0 downstream port to USB-C or USB3.0 upstream port.
- **USB Setup:** Select USB Type-C with USB 2.0 or USB 3.1. USB 3.1 is up to 2560x1440-60Hz.
- **Power Indicator:** Turn the power LED indicator on/off.
- **Power Key Lock:** To disable / enable power key
- **Key Lock:** Disable all key functions. Pressing the down button for more than five seconds to disable key lock function.
- **OSD Setup:** Adjusts the **OSD Timeout, DDC/CI,** and **Transparency** of the OSD screen.

- **DisplayPort Version:** Select DP 1.1 if your graphics card is not compatible with DP 1.1.
- **Information:** Displays the monitor information.
- **All Reset:** Selects “Yes” to revert all settings to the factory default mode.

3.2 Specifications

| Model | XG32VC |
|---------------------------------------|---|
| Panel Size | 31.5" W (80.1 cm) |
| Max. Resolution | 2560 x 1440 |
| Brightness (Typ.) | 440 nits (typical) |
| Intrinsic Contrast Ratio (Typ.) | 1000:1 |
| Viewing Angle (CR>10) | 178°(V) /178°(H) |
| Display Colors | 1.07B |
| Response Time | 4 ms (G To G), 1ms (MPRT) |
| Sound from HDMI | Yes |
| HDMI input | Yes |
| DisplayPort input | Yes |
| PBP | Yes |
| USB3.0 Port | Upstream x1, Downstream x2 (USB port without power charger when upstream no link) |
| USB-C port | Yes |
| Earphone | Yes |
| Power On Consumption | < 38 W* (Measuring a screen brightness of 200 nits without audio/ USB/ Card reader connection) |
| Chassis Colors | Black |
| Power saving mode | < 0.5W |
| Power off mode | < 0.5W |
| Tilt | -3.5° ~ +18.5° |
| Phys. Dimension with stand (WxHxD) | 713X552X279 mm |
| Phys. Dimension without stand (WxHxD) | 713X426X118 mm |
| Box Dimension (WxHxD) | 800X626X280 mm |
| Net Weight (Esti.) | 9.3 kg |
| Gross Weight (Esti.) | 13.6 kg |
| Voltage Rating | Adapter 19Vdc, 4.74A |
| Temperature (operating) | 0°C ~ 40°C |

3.3 Troubleshooting (FAQ)

| Problem | Possible Solution |
|--|--|
| Power LED is not ON | <ul style="list-style-type: none">• Press the ⏻ button to check if the monitor is in the ON mode.• Check if the power cord is properly connected to the monitor and the power outlet.• Check Power Indicator function in main menu OSD. Select "ON" to turn on power LED. |
| The power LED lights amber and there is no screen image | <ul style="list-style-type: none">• Check if the monitor and the computer are in the ON mode.• Make sure the signal cable is properly connected the monitor and the computer.• Inspect the signal cable and make sure none of the pins are bent.• Connect the computer with another available monitor to check if the computer is properly working. |
| Screen image is too light or dark | <ul style="list-style-type: none">• Adjust the Contrast and Brightness settings via OSD. |
| Screen image bounces or a wave pattern is present in the image | <ul style="list-style-type: none">• Make sure the signal cable is properly connected to the monitor and the computer.• Move electrical devices that may cause electrical interference. |
| Screen image has color defects (white does not look white) | <ul style="list-style-type: none">• Inspect the signal cable and make sure that none of the pins are bent.• Perform Reset via OSD.• Adjust the R/G/B color settings or select the Color Temperature via OSD. |
| No sound or sound is low | <ul style="list-style-type: none">• Adjust the volume settings of both your monitor and computer.• Make sure the computer sound card driver is properly installed and activated.• Check the audio source. |

3.4 Supported Timing List

| Timing | H Pixels | V Pixels | Frame Rate | Display Port | HDMI | Type-C |
|--------------|----------|----------|-------------|--------------|------|--------|
| PC Timing | 640 | 480 | 60 | ○ | ○ | ○ |
| PC Timing | 640 | 480 | 67 | ○ | ○ | ○ |
| PC Timing | 640 | 480 | 72 | ○ | ○ | ○ |
| PC Timing | 640 | 480 | 75 | ○ | ○ | ○ |
| PC Timing | 720 | 400 | 70 | ○ | ○ | ○ |
| PC Timing | 800 | 600 | 56 | ○ | ○ | ○ |
| PC Timing | 800 | 600 | 60 | ○ | ○ | ○ |
| PC Timing | 800 | 600 | 72 | ○ | ○ | ○ |
| PC Timing | 800 | 600 | 75 | ○ | ○ | ○ |
| PC Timing | 1024 | 768 | 60 | ○ | ○ | ○ |
| PC Timing | 1024 | 768 | 70 | ○ | ○ | ○ |
| PC Timing | 1024 | 768 | 75 | ○ | ○ | ○ |
| PC Timing | 1152 | 684 | 75 | ○ | ○ | ○ |
| PC Timing | 1280 | 720 | 60 | ○ | ○ | ○ |
| PC Timing | 1280 | 960 | 60 | ○ | ○ | ○ |
| PC Timing | 1280 | 1024 | 60 | ○ | ○ | ○ |
| PC Timing | 1280 | 1024 | 75 | ○ | ○ | ○ |
| PC Timing | 1440 | 900 | 60 | ○ | ○ | ○ |
| PC Timing | 1680 | 1050 | 60 | ○ | ○ | ○ |
| PC Timing | 1920 | 1080 | 60 | ○ | ○ | ○ |
| Video Timing | 640 | 480P | 59.94/60 | ○ | ○ | ○ |
| Video Timing | 720 | 480P | 59.94/60 | ○ | ○ | ○ |
| Video Timing | 720 | 576P | 50 | ○ | ○ | ○ |
| Video Timing | 1280 | 720P | 50 | ○ | ○ | ○ |
| Video Timing | 1280 | 720P | 59.94/60 | ○ | ○ | ○ |
| Video Timing | 1440 | 480P | 59.94/60 | ○ | ○ | ○ |
| Video Timing | 1440 | 576P | 50 | ○ | ○ | ○ |
| Video Timing | 1920 | 1080P | 50 | ○ | ○ | ○ |
| Video Timing | 1920 | 1080P | 59.94/60 | ○ | ○ | ○ |
| Video Timing | 1920 | 1080P | 119.88/120 | ○ | ○ | ○ |
| Video Timing | 2560 | 1080P | 59.94/60 | ○ | ○ | ○ |
| Video Timing | 2560 | 1080P | 119.88/120 | ○ | ○ | ○ |
| Video Timing | 2560 | 1440 | 144/583.6 | ○ | ○ | ○ |
| Video Timing | 2560 | 1440 | 100/410 | ○ | ○ | ○ |
| Video Timing | 2560 | 1440 | 170/660.79 | ○ | | ○ |
| Video Timing | 2560 | 1440 | 165/639.749 | ○ | | ○ |
| Video Timing | 3840 | 2160 | 50 | | ○ | |
| Video Timing | 3840 | 2160 | 59.94/60 | | ○ | |

*** The modes not listed in the above tables may not be supported. For optimal resolution, we recommend that you choose a mode listed in the above tables.**